

# The modernisation of crane systems

07.2021

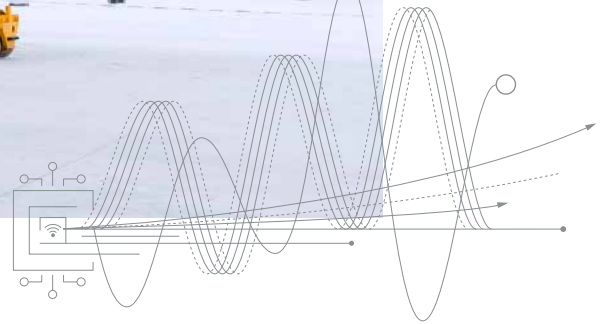

*Partner of Experts*

**STAHL**  
CraneSystems



# The modernisation of crane systems

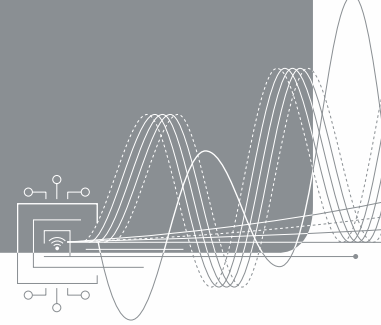

STAHL CraneSystems is a developer and manufacturer of hoists and crane components, and sells its products worldwide. With over 140 years of experience, we offer one of the most comprehensive product portfolios available on the market and are experts in explosion-proof crane technology. Our complete range of hoists, chain hoists, wire rope hoists, crane endcarriages, travel drives, wheel blocks and crane electrics are perfectly matched and work together efficiently. Their robust technology proves itself day after day in a wide variety of industries and environmental conditions, from freezing cold to extreme heat, in dense dust, tight spaces or with highly sensitive loads. Crane builders, machine and system manufacturers as well as planning companies and general contractors from around the world value the reliability of our components and complete solutions.

Our engineering department develops the right solution for even the most demanding special tasks. We also support our customers in planning and implementing international projects and manage country-specific approval and certification procedures. With a close-knit network of 9 subsidiaries and more than 140 crane building partners worldwide, we offer our customers direct contact persons and local service.

Our customers benefit from this expertise and service both in the planning and installation of new crane systems, crane technology and hoists, and in modernisation projects. With competent advice, optimum planning and our adaptable product portfolio, we find the right, economical and reliable solution for every modernisation requirement.

STAHL CraneSystems is part of the American Columbus McKinnon Group (CMCO) – one of the leading suppliers of products, technologies and services in the field of overhead materials handling. Within the group, STAHL CraneSystems works closely together with the company Magnetek. As a specialist in control technology, Magnetek with its frequency-regulated drives and radio systems is the ideal complement to STAHL CraneSystems' products. In this way, we use synergies to develop intelligent technology and powerful solutions for the future.

## The facts

---

- More than 140 years of experience and know-how
- Extensive and adaptable hoisting and crane technology programme
- Engineering department for custom solutions
- Decades of expertise in explosion protection
- Intelligent control technology from Magnetek
- Local contact persons worldwide

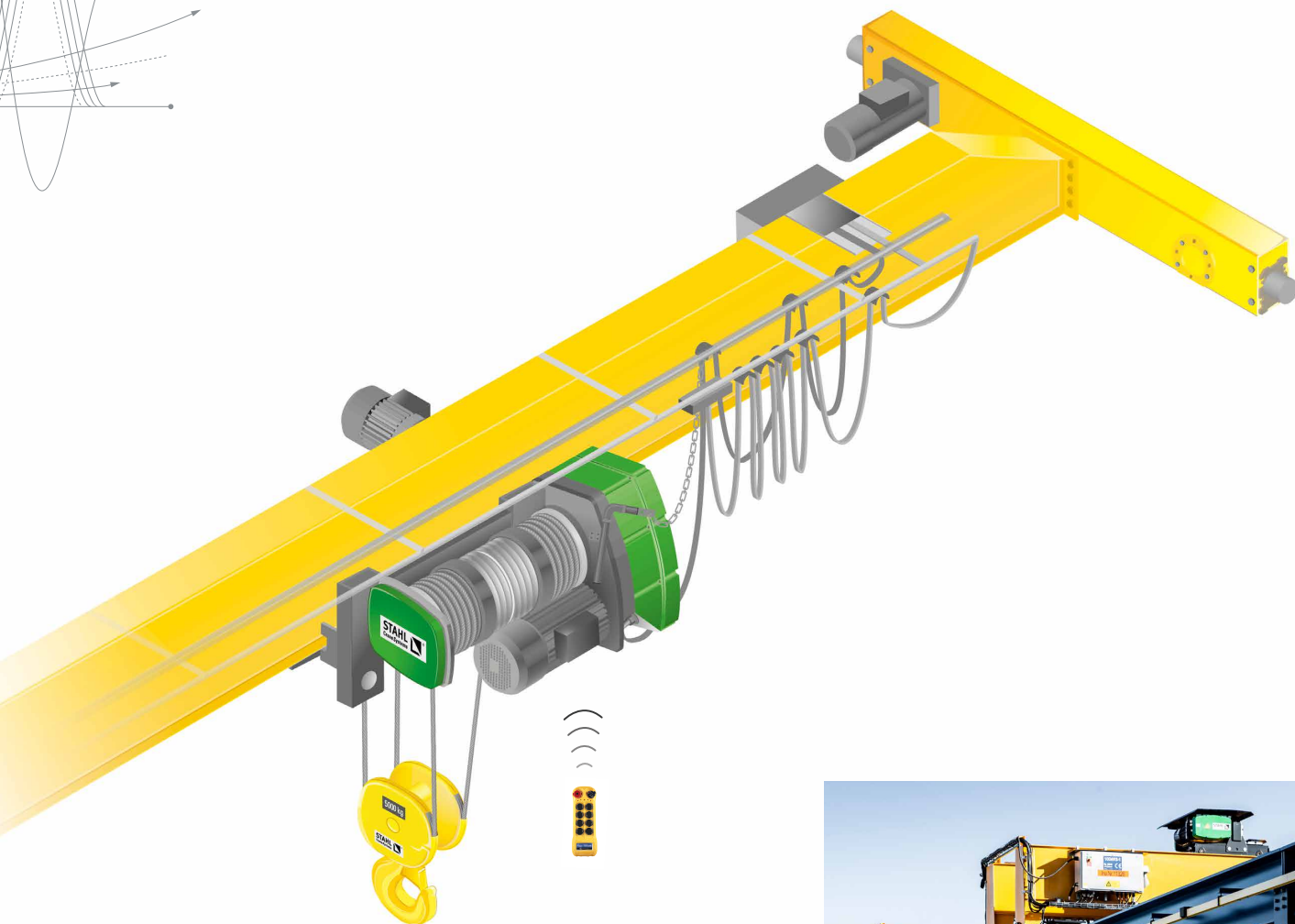
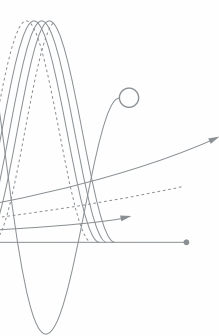

To cope with the increase in the volume and weight of material handled, the crane system in the storage yard of Stahlbau Schauenberg GmbH in Kirchzarten in southern Baden, Germany, was modernised with two double girder overhead travelling cranes with a span of 20 metres and a lifting capacity of 10 tons each.

# Reliable and safe

In the course of their long service lives, the demands placed on crane systems and crane technology change. New operating procedures, stricter safety requirements as well as high-cost and high-maintenance components present operators with the question of how the value of a system can be maintained and its efficiency increased. Instead of a mere repair or a comprehensive general overhaul, it is often worth considering modernising the system. It is cost-effective because specific replacement of individual components or systems means that many existing elements can continue to be used and the entire installation does not have to be replaced. At the same time, modernisation makes it possible to maintain the productivity of a plant and enhance its safety over the long term with selected adaptations.

## Goals of modernisation

- Increase in capacity, speed and availability
- Improvement in ergonomics and ease of use
- Reduction in wear and extension in service life
- New integration of safety functions
- Replacement of old components with state-of-the-art technologies



From consultation and planning to implementation of modernisation projects, our customers can rely on the know-how and pioneering technology of STAHL CraneSystems. Our experts develop custom-fit solutions and keep a close eye on the many requirements, specifications and guidelines regarding the modernisation project. In this way we offer our customers a high level of planning and cost dependability. We carry out the modernisation of hoists and crane components in all known standard and off-standard designs of all crane types, of safety equipment and of control technology for all hoisting and crane movements. The flexible technology can of course be adapted to existing connections, dimensions and control technology. Our broad network of trained partners, short delivery times and long-term availability of spare parts enable reliable conversion work and long-term on-site services.

#### Advantages of STAHL CraneSystems

- Competent solutions for all modernisation requirements
- One-stop consultation, planning and implementation
- Planning and cost dependability
- Flexible and adaptable technology for all crane types, hoisting and crane movements, and safety requirements
- Short delivery times
- Long-term availability of spare parts
- On-site services



# The modernisation components

The modernisation of mechanical, electrical and electronic components can make a system easier to use, more economical and safer. Of importance is that all components – both existing and new – work together smoothly and reliably. Our standard components are perfectly matched to each other and can be adapted easily to meet special modernisation requirements. Only the most common options are shown here. If you need more detailed information or variants, visit us at [www.stahlcranes.com](http://www.stahlcranes.com) or contact us directly.

## ST chain hoist



- Extensive chain hoist range for lifting capacities from 125 kg to 6,300 kg
- Suspension directly from the chain guide of solid cast iron
- Easy inspection and maintenance of the chain drive thanks to overmounted drive shaft
- Extremely short and compact construction ensures that space can be utilised to the maximum
- High ISO classification according to FEM/ISO standards
- Modern Kanban production, available with short lead time

## SH wire rope hoist



- 5 frame sizes, 27 load capacity variants
- Stationary design or different trolleys for cranes and systems applications
- Standard high-quality safety components for increased safety at work
- Largely maintenance-free, low wear and long service life according to FEM/ISO standards
- Equipped as standard with two hoisting and travel speeds
- Very smooth starting and braking characteristics
- U-shape makes for compact dimensions



### Endcarriages for bridge cranes



- 9 different wheel diameters from 90 mm to 500 mm
- Spans up to 40 m
- Safe working loads from 125 kg to 160,000 kg
- Higher safe working loads on request

### Endcarriages for suspension cranes



- 4 different wheel diameters from 80 mm to 200 mm
- Spans up to 28 m
- Safe working loads from 125 kg to 160,000 kg

### Load display



- SLD four-digit 7-segment load display, large format, luminous red
- Available with various interfaces including CAN
- Choice of 100 or 150 mm digit height
- Combinable with the hoist's overload sensor and the SMC multicontroller available as an option, no additional fixtures or load attachment devices are required, the headroom of the hoist remains unchanged

### Rope drive



- Optimised ratio of drum-to-sheave diameter ensures low wear on rope
- Flexible and long-lasting wire rope
- Wear-resistant return sheaves, fine machining provides rope-friendly grooves in rope drum
- Drum easily accessible for rope replacement
- Robust bottom hook block with low headroom despite maintaining the large dimensions of the hook

### Travel drives



- Low-maintenance crane travel drive
- In standard version with two speeds in a ratio of 1:4 or with stepless frequency control in a ratio of 1:10
- Integrated disc brake

### Rope and rope guide



- Highly flexible special rope with long service life
- Field-proven enclosed rope guide in spheroidal graphite cast iron has no temperature limitations
- The GJS material (previously designated GGG 40) is suitable for highest and lowest temperature ranges
- 360° rope tensioner prevents the formation of rope slack

### Cable power supply system



- Delivery complete with galvanised C-rail, mounting hardware, cantilever arms for clamping, cable trolley, cables and terminal box

### Plastic bus bar



- Delivery complete in straight sections, including mounting and connection hardware, current collector trolley

### Energy chain



- Power supply for the control cables along the crane bridge
- All cables running from the switch box to the hoist are integrated in a plastic chain
- More effective use of space underneath the crane by avoiding cable drag
- Protection of power and control cables against mechanical stress and reduction of the risk of external damage

### Control pendant



- Robust control pendant with EMERGENCY STOP palm button and control cable
- All switching elements for hoist, cross, and long travel are 2-step
- IP65 protection
- Additional buttons, such as horn activation, can be easily fitted

### Radio remote control units



- Pushbutton units with wrist strap, optionally with signal feedback from the crane
- Robust industrial-strength nylon and fiberglass composite materials used for housing
- IP66 protection
- Other radio remote control units on request

### Frequency inverter for driving



- Extension of system service life through stepless acceleration and deceleration
- Reduced load swing through soft starting and braking, fast and precise positioning of the load



### Overload cut-off



- Permanent electronic monitoring of suspended loads
- Limitation of the maximum load by load measurement at the rope anchorage possible in the case of multiple reeving

### Brake



- Low-maintenance, asbestos-free brake needs no adjustment
- Long service life thanks to oversized brake
- Brake easily accessible for inspection from outside
- Motor management ensures low wear
- IP65 protection, IP66 optional

### Motor



- Special-purpose motor for hoisting applications
- Classification according to FEM/ISO standards, high-duty-cycle and switching operation frequency motor
- IP55 protection, IP66 optional, thermal class F
- Motor outside rope drum, highly efficient motor cooling, maintenance-friendly
- Temperature control by PTC thermistors

### SLE/SMC control and motor management



- Condition monitoring as standard
- Inching operation is suppressed to reduce stress on equipment
- All common control voltages available
- High degree of safety due to oversized contactors
- Temperature monitoring of the hoist motor and travel motor

### Controls



- KSG distributed control: hoisting and cross travel on the crab, long travel on the crane bridge
- KSK complete control: all electrical devices in a panel box, for universal use
- 2 speeds
- IP55 protection
- Temperature range  $-20^{\circ}\text{C}$  to  $+40^{\circ}\text{C}$

# The modernisation projects

## Example 1 Four ST chain hoists with a total lifting capacity of 25,000 kg

The boat crane of a Dutch shipyard is equipped with four ST 60 chain hoists from STAHL CraneSystems and designed for a total lifting capacity up to 25,000 kg. Far above the portal crane, there is a further ST chain hoist to upright and stabilise the ship masts.

The crane is used to raise and lower yachts and sailing boats of various sizes from/into the water. The crane and crane controller were modernised to state of the art with the help of extensive technical changes.

The ST 60 chain hoists are suspended freely from hinges so that ships of various widths can be lifted. With suspended load, the hoists are able to tilt into the optimum position. Two of the chain hoists are mounted at a fixed point, and the other two on movable trolleys so that the distances between the hooks can be varied in dependence on the length of the boat. Load sensors, SMC condition monitoring units and an SCC total load controller measure the load at every chain hoist and protect the crane against overloading. An easy-to-read load display shows the total load suspended. The crane is controlled via the radio transmitter. Control is also possible with the control elements in the crane's control box. The four chain hoists can be operated together, individually and in pairs.

## The facts

- Portal crane with four ST 60 chain hoists with a lifting capacity of 6,300 kg each, two of which are movable
- Hook spacing can be adjusted to ships of various lengths
- Flexible suspension from hinges for ships of different widths
- Load display
- Load sensors and total load controller
- SMC multicontroller
- Radio remote control



## Example 2 Two SH wire rope hoists and a turntable

For the efficient loading of a system, STAHL CraneSystems engineers developed a customised solution in which two SH wire rope hoists travel into a system on electrically driven trolleys and are then automatically taken over by the system control. The workpieces are rotated and run in by the electrically driven turntable.

The intelligent control, the load limiting of the wire rope hoists, and the turntable are controlled by the condition monitoring system in combination with signal transmission via conductor lines. Overloading the conveyor system is prevented. If a wire rope hoist reaches its maximum load capacity, the load measurement on the second wire rope hoist comes into action and disconnects the hoisting motion. The hoisting motion is not released until the load has been set down and the hoist is unloaded. The two wire rope hoists and the turntable operate with standard radio remote controls.

After the hoist has been automatically taken over by the system control at a defined point, it can be moved within the system. The second wire rope hoist is now unloaded at the set-down point, then moved to the take-up point and loaded. The first wire rope hoist is released from the system by the radio remote control and moved to the set-down point via the turntable. It is not possible for the two wire rope hoists to travel onto the turntable at the same time.

### The facts

- Electrically driven turntable
- Condition monitoring
- Radio remote control with integrated turntable control and handover to the machine
- Electrically rotating load hook
- Meets long service life requirements according to the classifications in FEM/ISO standards

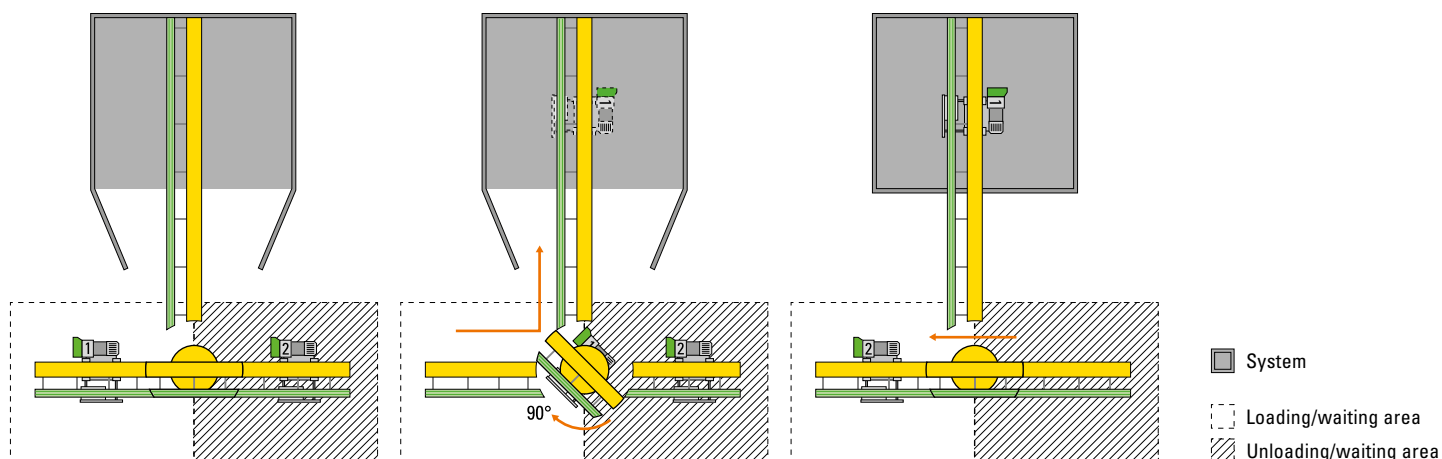

Experts worldwide rely on modernisations with STAHL CraneSystems. Innovative and well-conceived down to the smallest detail, we use our know-how to implement various modernisation projects with the utmost care. Whether replacing old trolleys, retrofitting sensors, installing safety technology, converting to overhead material transport or increasing the S.W.L. – in all countries, our engineering and crane technology repeatedly prove great flexibility, reliability and cost efficiency.

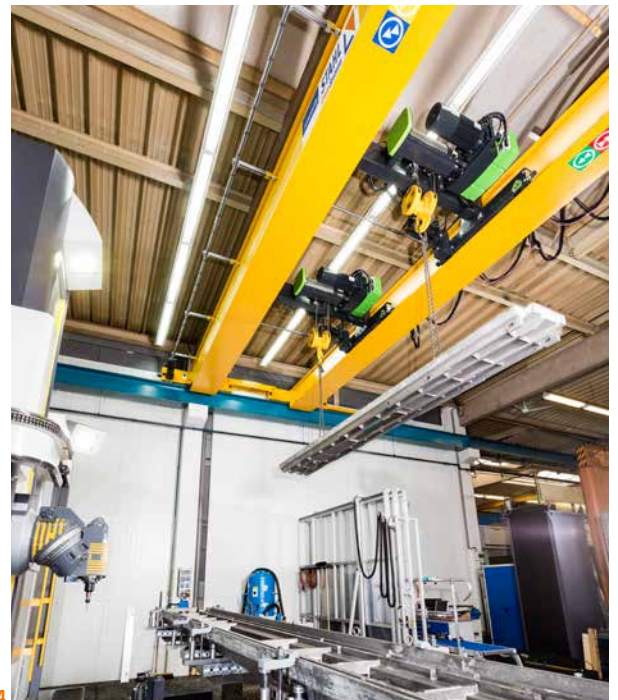
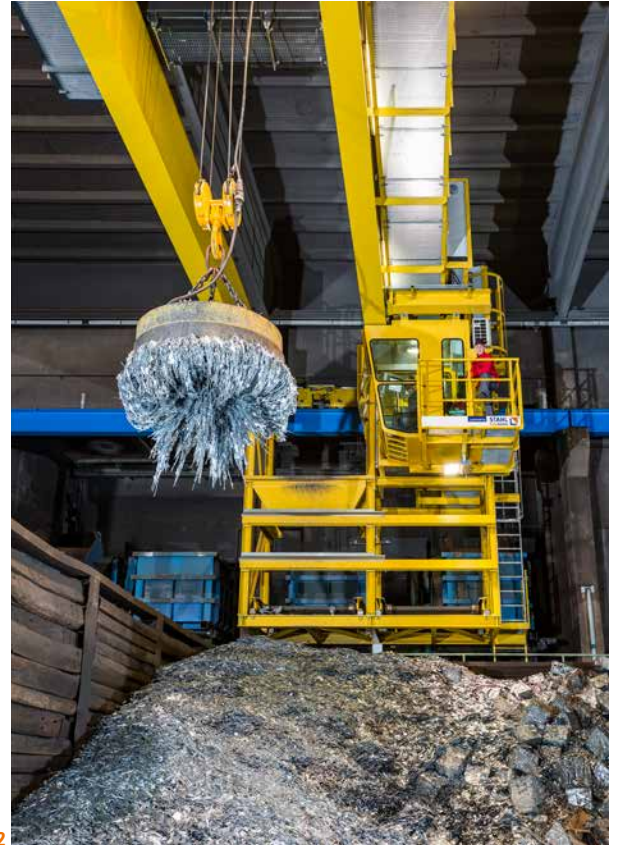



5



6



- 1 Due to the cantilevered and raised special design of the new crane runway, it protrudes 3 metres into the existing wide hall area. This area can now be served by both cranes, which are equipped with SH wire rope hoists.
- 2 During charging, the portal crane drives through the hall of the raw material mixing plant to the storage bunkers at speeds of up to 63 m/min. Thanks to the compact dimensions of the trolley and wire rope hoist, the new crane system could be integrated into the existing hall and still provide the required lifting height.
- 3 A series of ST chain hoists are used in England for maintenance and replacement of railway tracks. All hoists are equipped with special load handling equipment. To ensure that the chain hoists work synchronously, they are controlled centrally. They are switched off by gear-type limit switches, reliably limiting the hoisting process.
- 4 The existing crane runway and low ceiling of the hall left little space for the new crane. The compact SH wire rope hoists, each with an S.W.L. of 8 tons in tandem operation, run on a special trolley between the box girders.
- 5 The basis for the special stacking crane is a custom solution with an SH60 wire rope hoist that was equipped for this application with a double-grooved rope drum. The concrete elements weighing up to 5.7 t are lifted from the production line on to transport vehicles using a telescopic lifting mast. The modernisation has increased the handling of pre-cast elements by up to 20%.
- 6 The two double-girder suspension cranes are used in a carpentry shop to transport wooden beams and prefabricated walls. Only a few centimetres remain between the suspension crane and the roof trusses. For this reason, the ST20 chain hoist was raised to gain lifting height.
- 7 The two-part crane is equipped with 5 photo-electric barriers for non-contact signal transmission between the crane bridges. When the crane operator gives the command to lock, the control system brakes automatically on approach and locks the crane bridges.

7

## The support

STAHL CraneSystems is committed to quality, right down to the smallest detail.

Developed with care by our engineers and experts, our products are manufactured with care to the highest levels of performance and reliability.

This high level of quality not only applies to the products we design, but also to the service we provide to our customers around the world.

Our global sales team works exclusively with capable, professional crane manufacturing partners to provide you with industry-leading service and training. When you purchase a full crane system or STAHL CraneSystems components, you can expect optimum support from our partners. Whether you need a consultation, installation of a new system, system testing, maintenance, modernisation, spare parts, or training, we are here, together with our crane building partners, to provide you with streamlined, expert support anywhere around the globe.





**Spare parts – available around the clock**

Our own subsidiaries and numerous partners around the world ensure a reliable supply of spare parts and expert assistance in your area. Even decades after a series has been discontinued, spare parts are available all over the world around the clock.



**Training courses**

We are dedicated to safety. With training courses, webinars, and online safety tools and information, we keep our regional crane manufacturing partners and end users educated on how to best use and service our products. This information covers all of our main product lines, providing practical and theoretical knowledge relevant to individual products and full crane systems.

For training materials or information on our full training offering, visit [www.stahlcranes.com/en/support](http://www.stahlcranes.com/en/support)



**Factory service centre – on duty around the world**

To help support our customers, our factory service center is available to provide assistance and expertise to field technicians as well as crane and systems manufacturers – anytime, anywhere. With modern diagnostic tools and condition monitoring systems, we are here to support your service and maintenance needs. We will help ensure your system and operators stay safe. You can rely on us.

To reach our factory service center, contact [customer.service@stahlcranes.com](mailto:customer.service@stahlcranes.com)



**MarketingPortal plus – our online support**

At [mplusplus.stahlcranes.com](http://mplusplus.stahlcranes.com) you can view or download the information you need quickly and conveniently, including brochures, product information, technical documents, illustrations, and much more.





You can find this and other brochures at [www.stahlcranes.com/download](http://www.stahlcranes.com/download). We will gladly also send them to you by post.

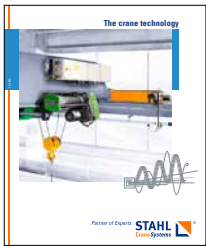

Presented by

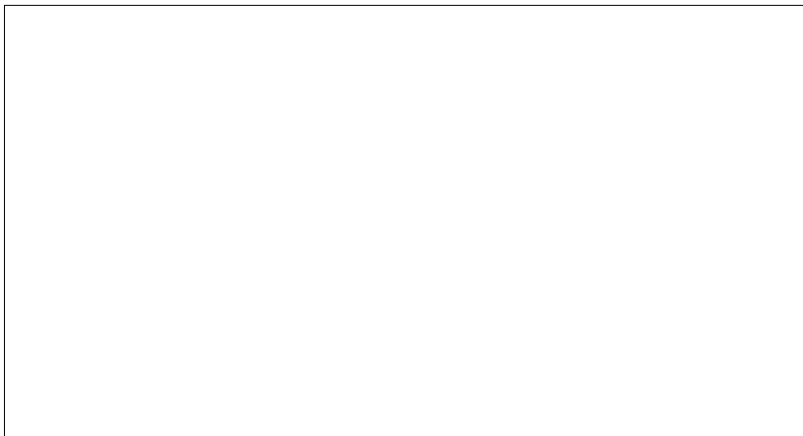

STAHL CraneSystems GmbH  
Daimlerstr. 6, 74653 Künzelsau, Germany  
Tel +49 7940 128-0, Fax +49 7940 55665  
[marketing.scs@stahlcranes.com](mailto:marketing.scs@stahlcranes.com)  
[www.stahlcranes.com](http://www.stahlcranes.com)



MEMBERS OF COLUMBUS MCKINNON

