

Textile Lifting Slings

Yale webbing slings and round slings are produced from high-tensile quality polyester (PES) in accordance with EN 1492, parts 1 and 2. The highly flexible and versatile material exerts evenly distributed pressure on pressure-sensitive and tension-sensitive loads; it is not subject to material ageing or brittleness and is heat-resistant up to +100°C.

Lashing Systems

Yale lashing belts are produced from polyester (PES) according to EN 12195-2. The extremely resilient belt material is resistant to stretching and abrasion; it guarantees a high load bearing capacity and a long service life. All Yale lashing belts are stretched belts, thermally fixed and protected against abrasion.

Entertainment

Yale Entertainment accessories are specially manufactured to meet the high demands of this segment. The highly flexible and adaptable material exerts an even pressure distribution on pressure- and tension-sensitive loads, shows no material ageing or embrittlement and is heat-resistant up to +100 °C.

INFO

Please note our user instructions at the beginning of each chapter

Table of contents

	Page
Round slings	248 - 253
Round sling assembly	253 - 255
Webbing slings	256 - 260
Gas cylinder transport harnesses	287
Textile lifting slings accessories	261 - 264

	Page
Trucker-Set	265
Textile lashings	270 - 277
Special textile lashings	277
Lashing systems accessories	278 - 281

	Page
Round slings	282 - 283
Entertainment accessories	283
Theater load belts	284
Textile lashings	284 - 286

Yale

TEXTILE LIFTING SLINGS



SAFE

This user information presents a general overview regarding the application of textile lifting slings and does not substitute the existing operating instructions for specific products!

Lifting operations with textile slings may be carried out by competent users (trained in theory and practice) only.

When operated correctly, our textile slings offer the highest degree of safety in line with long life expectancy and avoid damage to products and people.

Limitations of use

Loading

Textile lifting slings must not be overloaded. The capacities for the most important lifting/sliding methods are indicated on the identity label. Always observe the maximum angle from the vertical (angle β)!

Temperature

Textile lifting slings made from polyester are admitted for applications at temperatures between -40°C and $+100^{\circ}\text{C}$. This temperature area may change in chemical environments. The woven structure of the drenched textiles at temperatures below 0°C are susceptible to damage due to the formation of ice.

Ice will reduce the flexibility of the lifting sling! At temperatures below 0°C , dry lifting equipment should be used only! In dry condition, polyester features a high electrical resistance and provides an insulating effect between load and crane hook (e.g. during welding jobs – observe temperatures!).

Shock loading

Textile lifting and lashing equipment should not be subjected to sharp jerks and jolts in order to avoid heavy forces which may be considerably higher than the actual load weight!

Chemicals

Particular caution is required when using textile lifting equipment in areas where chemicals are present. Polyester has good resistance against mineral acids but will be destroyed by alkaline – consult our experts for advice in your specific application!

Acid may cause material brittleness to steel fittings of textile lifting slings! Harmless acid solutions may concentrate by evaporation to an extent that they provoke damages. Affected textile lifting equipment must be thoroughly rinsed in cold water, dried in open air and inspected by a competent person.

Transport of people

Transport of people with textile lifting equipment is generally forbidden!

Operation in danger zones

Lifting or transport of loads must be avoided while personnel are in the danger zone.

People are not allowed to pass over or under a suspended load!

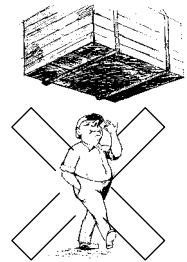

Application advices

- The operator may start moving the load only after it has been correctly attached and all personnel are clear of the danger zone.
- Loads must not be left unattended in raised or tensioned condition for a longer period of time.
- Flat webbing or round slings must not be used in knotted, tied or twisted condition and may only be used for the attachment of loads.
- Prior to every use, textile lifting and lashing equipment must be examined with regard to obvious defects. Ensure that their identity and dimensions are correct and that they are provided with a legible capacity label. Never use lifting equipment which is defective or not labelled!
- Damage of the capacity label can be avoided by keeping it away from the load, the hook or choke hitch operations!
- The angle of the eye must not exceed 20° in order to avoid inadmissible strain on the seams! This will be ensured when the eye length is approx. 4 times the width of the hook.
- Hooks or other lifting devices in loaded condition must not be attached in the area of sewn overlaps or at the seam of the round sling sleeve. Make sure that the seams are positioned in the straight part of the lifting device!

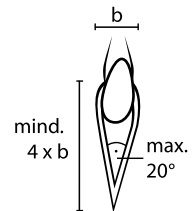

- Hooks should be provided with sufficient radius. The contact area of the web sling must be straight, so that the entire cross section of the sling is loaded equally. If the carrying width of flat webbing sling is below 75 mm, the radius curve of the lifting device must be at least $\frac{3}{4}$ of the width of the webbing sling.

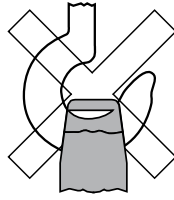

- Take care that round slings do not overlap in the crane hook. They must have sufficient space in the hook mouth as well as at the load, so they can assume their natural, flattened profile and provide even loading over the full width of the round sling.
- Flat webbing slings should be applied in such a way that they can carry the load over the full sling width. Greater angles from the vertical will strain the edges of the slings and possibly lead to breakage!
- Textile lashing equipment must be protected against sharp edges, friction and abrasion at both load and lifting device. A radius edge is classed as sharp, if it is less than the thickness of the flat webbing or round sling (in flat, loaded condition).
- Never push or place the load onto the lifting device! Never pull the load over rough surfaces or edges and do not drag from underneath a load!
- In "choke hitch" the textile sling should be positioned so that it can form a natural angle of 60° and that heat due to friction is avoided. Never re-adjust the choke hitch and prevent heat development by friction (slipping of load). In order to lift loads with plain or slippery surface we recommend double choke hitch.

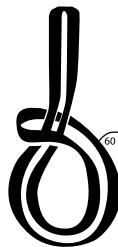

- Round slings and flat webbing slings will stretch under load by approx. 3 - 5%. This has to be strictly considered as it may cause abrasion resp. damages at sensible surfaces. As prevention we recommend the use of protective sleeves and edge protectors. In case of (intended) load movements during lifting operations and resulting friction, e.g. during assembling or turning of goods, the surface or edges of the load must be secured by protective sleeves or corner protectors, which will safeguard the lashing device and leave sufficient space for movement and alignment without greater friction (see dim. B in the following drawing)



- If more than one sling is used to lift a load, these should be of same type with preferably same length in order to avoid different elongation behaviour and allow carrying ability over the full width (employ smallest angle from the vertical or use spreader beam instead).
- Textile lifting equipment must be stored in a clean, dry and well ventilated area. Avoid exposure to direct sunlight and other sources of UV. Keep them away from other heat sources, chemicals, fumes and corroded surfaces as they will have a negative effect on the life expectancy of the sling. Slings should not be dried near open fires or other hot places.
- Textile slings with obvious damages, overloading or other detrimental influences must be taken out of use and may be returned to service after inspection and possible repair only.

O
L
N

INFO

You will find the General Terms and Conditions at the end of the catalogue.

Please note the information on our training courses on page 4.

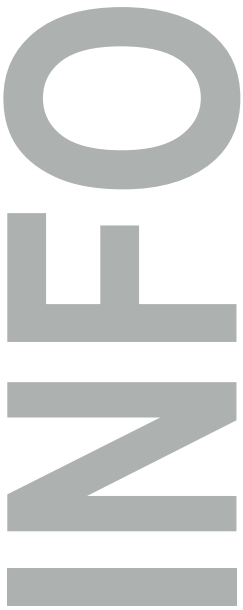

Maintenance and repair

Inspections and tests must be performed by competent persons or specialist workshops only.

Inspections

Depending on application, textile lifting equipment must be subjected to regular inspections by competent persons, at least once per year. The inspection must be visual and extended to the following deficiencies:

- Complete and legible identity label
- Damages by chemical influence, e.g. local soaking, chipping of yarns or heat (hardening)
- Steel links must not show deformations, grooves or reduction to the cross section of more than 10%.
Check for cracks; possible welding points must be visible and not covered by the webbing
- Inspections have to be recorded
- Defective slings have to be taken out of service immediately and must be stored separately!

Criteria for disposal

Textile slings must not be used any longer if e.g. :

- The marking (identity label) is missing or illegible.
- Detrimental impacts have occurred, e.g. overloading, shock loading, chemical influence or heat.

Flat webbing slings:

- Damages of selvage, defects of the woven structure by abrasion, cuts or yarn breakages have occurred.
If 10% or more of the webbing sling cross section is damaged the sling must be discarded.
- Heavy deformation or melting of yarns due to heat (shiny surface and/or hardened webbing) can be recognized.
- Load bearing seams are defective.

Round slings:

- The outside (sleeve) is damaged by cuts or abrasion.
- The inside (polyester yarns) of the sling is visible.
- The seams of the sleeve are damaged.

INFO

Yale hoists and trolleys are not designed for passenger elevation applications and must not be used for this purpose.

Webbing slings Rated capacities for different slinging methods

		WLL (kg) with one webbing sling					WLL (kg) with two webbing slings			
		straight pull	choke hitch	basket angle β			straight angle β		choke hitch angle β	
				up to 7°	7°- 45°	45°- 60°	7°- 45°	45°- 60°	7°- 45°	45°- 60°
Factor										
		1.0	0.8	2.0	1.4	1.0	1.4	1.0	1.12	0.8
1000 kg		1000	800	2000	1400	1000	1400	1000	1120	800
2000 kg		2000	1600	4000	2800	2000	2800	2000	2240	1600
3000 kg		3000	2400	6000	4200	3000	4200	3000	3360	2400
4000 kg		4000	3200	8000	5600	4000	5600	4000	4480	3200
5000 kg		5000	4000	10000	7000	5000	7000	5000	5600	4000
6000 kg		6000	4800	12000	8400	6000	8400	6000	6720	4800
8000 kg		8000	6400	16000	11200	8000	11200	8000	8960	6400
10000 kg		10000	8000	20000	14000	10000	14000	10000	11200	8000

Round slings Rated capacities for different slinging methods

		WLL (kg) with one round sling					WLL (kg) with two round slings					
		straight pull	choke hitch	basket angle β			straight angle β		choke hitch angle β			
				up to 7°	7°- 45°	45°- 60°	7°- 45°	45°- 60°	7°- 45°	45°- 60°		
Factor												
		1.0	0.8	2.0	1.4	1.0	0.7	0.5	1.4	1.0	1.12	0.8
1000 kg		1000	800	2000	1400	1000	700	500	1400	1000	1120	800
2000 kg		2000	1600	4000	2800	2000	1400	1000	2800	2000	2240	1600
3000 kg		3000	2400	6000	4200	3000	2100	1500	4200	3000	3360	2400
4000 kg		4000	3200	8000	5600	4000	2800	2000	5600	4000	4480	3200
5000 kg		5000	4000	10000	7000	5000	3500	2500	7000	5000	5600	4000
6000 kg		6000	4800	12000	8400	6000	4200	3000	8400	6000	6720	4800
8000 kg		8000	6400	16000	11200	8000	5600	4000	11200	8000	8960	6400
10000 kg		10000	8000	20000	14000	10000	7000	5000	14000	10000	11200	8000



RSD

Round sling with duplex sleeve

Made from polyester (PES), EN 1492-2 with double stitch-less protection sleeve, with capacity label.

Features

- With double protection sleeve, PU-starched, thermally fixed.
- Colour coding of the protective sleeve.
- Printed-on capacities.
- Woven tonnage stripes, per ton capacity 1 stripe.
- Low weight allows easy handling.
- Protection against hand injuries.
- Protection against cargo surface damage.
- Highly flexible and adaptable to given shapes.
- UV-resistant, eliminating material ageing or embrittlement.
- Heat resistant up to +100°C.
- Moisture-resistant fabric, thus preventing frost damage (up to approx. -40°C).

Technical data RSD

Model	Colour code EN 1492	Capacity WLL, with one sling, straight pull kg	Capacity WLL, with one sling, choke hitch kg	Capacity WLL, with one sling, basket, angle β up to 7° kg	Capacity WLL, with one sling, basket, angle β 7°- 45° kg	Capacity WLL, with one sling, basket, angle β 45°- 60° kg	Width approx. under load mm	Thickness approx. under load mm	Shortest possible length mm
RSD-01000	violet	1000	800	2000	1400	1000	52	5	500
RSD-02000	green	2000	1600	4000	2800	2000	57	6	500
RSD-03000	yellow	3000	2400	6000	4200	3000	71	9	500
RSD-04000	grey	4000	3200	8000	5600	4000	76	9	500

RSX Round sling with extra thick single sleeve

Made from polyester (PES), EN 1492-2 with extra strong stitchless protection sleeve, with capacity label.

Features

- Optimized woven structure, PU-starched, thermally fixed.
- Easy identification of the annually required UVV tests through an additional label showing a check list.
- Colour coding of the protective sleeve.
- Printed-on capacities.
- Woven tonnage stripes, per ton capacity 1 stripe.
- Low weight allows easy handling.
- Protection against hand injuries.
- Protection against cargo surface damage.
- Highly flexible and adaptable to given shapes.
- UV-resistant, eliminating material ageing or embrittlement.
- Heat resistant up to +100°C.
- Moisture-resistant fabric, thus preventing frost damage (up to approx. -40°C).



INFO

Special lengths available on request.

Technical data RSX

Model	Colour code EN 1492	Capacity WLL, with one sling, straight pull kg	Capacity WLL, with one sling, choke hitch kg	Capacity WLL, with one sling, basket, angle β up to 7° kg	Capacity WLL, with one sling, basket, angle β 7°- 45° kg	Capacity WLL, with one sling, basket, angle β 45°- 60° kg	Width approx. under load mm	Thickness approx. under load mm	Shortest possible length mm
RSX-01000	violet	1000	800	2000	1400	1000	52	10	500
RSX-02000	green	2000	1600	4000	2800	2000	57	10	500
RSX-03000	yellow	3000	2400	6000	4200	3000	71	15	500
RSX-04000	grey	4000	3200	8000	5600	4000	76	15	500
RSX-05000	red	5000	4000	10000	7000	5000	86	20	1000
RSX-06000	brown	6000	4800	12000	8400	6000	96	20	1000
RSX-08000	blue	8000	6400	16000	11200	8000	112	25	1000
RSX-10000	orange	10000	8000	20000	14000	10000	130	30	1000



RSX-XL

Heavy duty round sling with extra thick single sleeve

Made from polyester (PES), EN 1492-2 with extra strong stitchless protection sleeve, with capacity label.

Features

- Optimized woven structure, PU-starched, thermally fixed.
- Easy identification of the annually required UVV tests through an additional label showing a check list.
- Colour coding of the protective sleeve.
- Low weight allows easy handling.
- Protection against hand injuries.
- Protection against cargo surface damage.
- Highly flexible and adaptable to given shapes.
- UV-resistant, eliminating material ageing or embrittlement.
- Heat resistant up to +100°C.
- Moisture-resistant fabric, thus preventing frost damage (up to approx. -40°C).



Technical data RSX-XL

Model	Colour code EN 1492	Capacity WLL, with one sling, straight pull kg	Capacity WLL, with one sling, choke hitch kg	Capacity WLL, with one sling, basket, angle β up to 7° kg	Capacity WLL, with one sling, basket, angle β 7°- 45° kg	Capacity WLL, with one sling, basket, angle β 45°- 60° kg	Width approx. under load mm	Shortest possible length mm
RSX-XL-12000	orange	12000	9600	24000	16800	12000	150	1000
RSX-XL-15000	orange	15000	12000	30000	21000	15000	150	1000
RSX-XL-20000	orange	20000	16000	40000	28000	20000	180	1000
RSX-XL-25000	orange	25000	20000	50000	35000	25000	180	1000
RSX-XL-30000	orange	30000	24000	60000	42000	30000	210	1000
RSX-XL-40000	orange	40000	32000	80000	56000	40000	210	1000
RSX-XL-50000	orange	50000	40000	100000	70000	50000	240	1000
RSX-XL-60000	orange	60000	48000	120000	84000	60000	240	1000
RSX-XL-80000	orange	80000	64000	160000	112000	80000	270	1500
RSX-XL-100000	orange	100000	80000	200000	140000	100000	270	1500
RSX-XL-125000	orange	125000	100000	250000	175000	125000	270	2000
RSX-XL-150000	orange	150000	120000	300000	210000	150000	270	2000



RSE

Round sling with single sleeve

Made from polyester (PES), EN 1492-2 with single stitch-less protection sleeve, with capacity label.

Features

- With single sleeve, PU-starched, thermally fixed.
- Colour coding of the protective sleeve.
- Printed-on capacities.
- Woven tonnage stripes, per ton capacity 1 stripe (applies only to round slings up to 10t).
- Low weight allows easy handling.
- Protection against hand injuries.
- Protection against cargo surface damage.
- Highly flexible and adaptable to given shapes.
- UV-resistant, eliminating material ageing or embrittlement.
- Heat resistant up to +100°C.
- Moisture-resistant fabric, thus preventing frost damage (up to approx. -40°C).

Technical data RSE

Model	Colour code EN 1492	Capacity WLL, with one sling, straight pull kg	Capacity WLL, with one sling, choke hitch kg	Capacity WLL, with one sling, basket, angle β up to 7° kg	Capacity WLL, with one sling, basket, angle β 7°- 45° kg	Capacity WLL, with one sling, basket, angle β 45°- 60° kg	Width approx. under load mm	Thickness approx. under load mm	Shortest possible length mm
RSE-01000	violet	1000	800	2000	1400	1000	50	10	500
RSE-02000	green	2000	1600	4000	2800	2000	55	10	500
RSE-03000	yellow	3000	2400	6000	4200	3000	60	15	500
RSE-04000	grey	4000	3200	8000	5600	4000	75	15	500
RSE-05000	red	5000	4000	10000	7000	5000	85	20	1000
RSE-06000	brown	6000	4800	12000	8400	6000	90	20	1000
RSE-08000	blue	8000	6400	16000	11200	8000	100	25	1000
RSE-10000	orange	10000	8000	20000	14000	10000	120	30	1000

20 RSE - Round slings, EN 1492-2

with different working loads and lengths.

With each sports bag you receive:

- 2 x RSE 01000, WLL 1000 kg, 0.5 m length
- 4 x RSE 01000, WLL 1000 kg, 1.0 m length
- 2 x RSE 01000, WLL 1000 kg, 1.5 m length
- 4 x RSE 01000, WLL 1000 kg, 2.0 m length
- 2 x RSE 02000, WLL 2000 kg, 1.0 m length
- 2 x RSE 02000, WLL 2000 kg, 2.0 m length
- 2 x RSE 02000, WLL 2000 kg, 3.0 m length
- 2 x RSE 03000, WLL 3000 kg, 2.0 m length



Art.-No.: N33500011

Minimum purchase: 3 bags



Including sports bag

Round sling assembly Rated capacities for different slinging methods

	single legged		double legged				three and four legged	
	straight	choke hitch	straight angle β 0° - 45°	choke hitch	straight angle β 45° - 60°	choke hitch	straight angle β 0° - 45° 45° - 60°	
Factor	1.0	0.8	1.4	1.1	1.0	0.8	2.1	1.5
1000 kg	1000	800	1400	1100	1000	800	2100	1500
2000 kg	2000	1600	2800	2200	2000	1600	4200	3000
3000 kg	3000	2400	4200	3300	3000	2400	6300	4500
4000 kg	4000	3200	5600	4400	4000	3200	8400	6000
5000 kg	5000	4000	7000	5500	5000	4000	10500	7500



RSG Round sling assembly single legged

EN 1492-2 with high tensile forgings EN 1677.

Technical data RSG single legged

Model	Capacity WLL straight pull kg
RSG-01000-1-SIKA	1000
RSG-02000-1-SIKA	2000
RSG-03000-1-SIKA	3000
RSG-04000-1-SIKA	4000
RSG-05000-1-SIKA	5000



RSG Round sling assembly double legged

EN 1492-2 with high tensile forgings EN 1677.

Technical data RSG double legged

Model	Capacity WLL, straight angle β 0° - 45° kg	Capacity WLL, straight angle β 45° - 60° kg
RSG-01000-2-SIKA	1400	1000
RSG-02000-2-SIKA	2800	2000
RSG-03000-2-SIKA	4200	3000
RSG-04000-2-SIKA	5600	4000
RSG-05000-2-SIKA	7000	5000

INFO

Standard length 1-3 m. Attention: The mentioned lengths refer to the useable length L1 of the round sling.

RSG

Round sling assembly three legged

EN 1492-2 with high tensile forgings EN 1677.

Technical data RSG three legged

Model	Capacity WLL, straight angle β 0°- 45° kg	Capacity WLL, straight angle β 45°- 60° kg
RSG-01000-3-SIKA	2100	1500
RSG-02000-3-SIKA	4200	3000
RSG-03000-3-SIKA	6300	4500
RSG-04000-3-SIKA	8400	6000
RSG-05000-3-SIKA	10500	7500



RSG

Round sling assembly four legged

EN 1492-2 with high tensile forgings EN 1677.

Technical data RSG four legged

Model	Capacity WLL, straight angle β 0°- 45° kg	Capacity WLL, straight angle β 45°- 60° kg
RSG-01000-4-SIKA	2100	1500
RSG-02000-4-SIKA	4200	3000
RSG-03000-4-SIKA	6300	4500
RSG-04000-4-SIKA	8400	6000
RSG-05000-4-SIKA	10500	7500



INFO

Other lengths and capacities upon request.



HSE Endless flat webbing sling, single ply

Made from polyester (PES), EN 1492-1 form A2, with capacity label.

Features

- Single ply, PU-starched, thermally fixed.
- Colour coded webbing.
- Woven tonnage stripes.
- Low weight allows easy handling.
- Protection against hand injuries.
- Protection against cargo surface damage.
- Consistent pressure distribution onto pressure- and pull sensitive loads.
- UV-resistant, eliminating material ageing or embrittlement.
- Heat resistant up to +100°C.
- Moisture-resistant fabric, thus preventing frost damage (up to approx. -40°C).
- Low elongation (< 4 %).

Technical data HSE

Model	Colour code EN 1492	Capacity WLL, with one sling, straight pull kg	Capacity WLL, with one sling, choke hitch kg	Capacity WLL, with one sling, basket, angle β up to 7° kg	Capacity WLL, with one sling, basket, angle β 7°- 45° kg	Capacity WLL, with one sling, basket, angle β 45°- 60° kg	Webbing width mm	Shortest possible length mm
HSE-01000	violet	1000	800	2000	1400	1000	30	500
HSE-02000	green	2000	1600	4000	2800	2000	60	500
HSE-03000	yellow	3000	2400	6000	4200	3000	90	500

INFO

Further capacities (up to 20t) and special lengths available on request.

HSE-E Einwegband Disposable endless flat woven webbing slings, single ply

Made from polyester (PES), DIN 60005, with capacity label.



Features

- Single ply, PU-starched, thermally fixed.
- Low weight allows easy handling.
- Protection against hand injuries.
- Protection against cargo surface damage.
- Consistent pressure distribution onto pressure- and pull sensitive loads.
- UV-resistant, eliminating material ageing or embrittlement.
- Heat resistant up to +100°C.
- Moisture-resistant fabric, thus preventing frost damage (up to approx. -40°C).
- Low elongation (<4%).

INFO

Min. order quantity: 100 pcs. per product code

Technical data HSE-E

Model	Capacity WLL, with one sling, straight pull kg	Capacity WLL, with one sling, choke hitch kg	Capacity WLL, with one sling, basket, angle β up to 7° kg	Capacity WLL, with one sling, basket, angle β 7° - 45° kg	Capacity WLL, with one sling, basket, angle β 45° - 60° kg	Webbing width mm	Shortest possible length mm
HSE-E-00500	500	400	1000	700	500	25	200
HSE-E-00750	750	600	1500	1050	750	48	200
HSE-E-01000	1000	800	2000	1400	1000	35	200
HSE-E-01500	1500	1200	3000	2100	1500	50	250



HBD Flat webbing sling, duplex construction, reinforced eyes

Made from polyester (PES), EN 1492-1 form B2, with capacity label.

Features

- Duplex construction, PU-starched, thermally fixed.
- With reinforced eyes.
- Woven tonnage stripes (up to WLL 10 t).
- Low weight allows easy handling.
- Protection against hand injuries.
- Protection against cargo surface damage.
- Consistent pressure distribution onto pressure- and pull sensitive loads.
- UV-resistant, eliminating material ageing or embrittlement.
- Heat resistant up to +100°C.
- Moisture-resistant fabric, thus preventing frost damage (up to approx. -40°C).
- Low elongation (<4 %).

INFO

Special lengths available on request.

Technical data HBD

Model	Colour code EN 1492	Capacity WLL, with one sling, straight pull kg	Capacity WLL, with one sling, choke hitch kg	Capacity WLL, einfach umgelegt angle β up to 7° kg	Capacity WLL, einfach umgelegt angle β 7° - 45° kg	Capacity WLL, einfach umgelegt angle β 45° - 60° kg	Webbing width mm	Eye length approx. mm	Eye width approx. mm	Shortest possible length mm
HBD-01000	violet	1000	800	2000	1400	1000	30	300	30	750
HBD-02000	green	2000	1600	4000	2800	2000	60	350	30	1000
HBD-03000	yellow	3000	2400	6000	4200	3000	90	400	45	1000
HBD-04000	grey	4000	3200	8000	5600	4000	120	500	60	1500
HBD-05000	red	5000	4000	10000	7000	5000	150	550	75	1500
HBD-06000	brown	6000	4800	12000	8400	6000	180	600	90	2000
HBD-08000	blue	8000	6400	16000	11200	8000	240	650	120	2500
HBD-10000	orange	10000	8000	20000	14000	10000	300	900	150	2500
HBD-12000	orange	12000	9600	24000	16800	12000	300	900	150	3000
HBD-15000	orange	15000	12000	30000	21000	15000	400	1100	200	4000

HBQ Flat webbing sling, four ply, reinforced eyes

Made from polyester (PES), EN 1492-1 form B4,
with capacity label.

Features

- Four-layered stitched, PU-starched, thermally fixed.
- With reinforced eyes.
- Low weight allows easy handling.
- Protection against hand injuries.
- Protection against cargo surface damage.
- Consistent pressure distribution onto pressure- and pull sensitive loads.
- UV-resistant, eliminating material ageing or embrittlement.
- Heat resistant up to +100°C.
- Moisture-resistant fabric, thus preventing frost damage (up to approx. -40°C).
- Low elongation (<4 %).



INFO

Other capacities upon request.

Technical data HBQ

Model	Capacity WLL, with one sling, straight pull kg	Capacity WLL, with one sling, choke hitch kg	Capacity WLL, with one sling, basket, angle β up to 7° kg	Capacity WLL, with one sling, basket, angle β 7°- 45° kg	Capacity WLL, with one sling, basket, angle β 45°- 60° kg	Webbing width mm	Eye length approx. mm	Eye width approx. mm	Shortest possible length mm
HBQ-04000	4000	3200	8000	5600	4000	60	350	30	1000
HBQ-06000	6000	4800	12000	8400	6000	90	400	45	1000
HBQ-08000	8000	6400	16000	11200	8000	120	500	60	1500
HBQ-10000	10000	8000	20000	14000	10000	150	550	75	1500
HBQ-12000	12000	9600	24000	16800	12000	180	600	90	2000
HBQ-16000	16000	12800	32000	22400	16000	240	650	120	2500
HBQ-20000	20000	16000	40000	28000	20000	300	900	150	2500
HBQ-25000	25000	20000	50000	35000	25000	300	900	150	3000
HBQ-30000	30000	24000	60000	42000	30000	400	1100	200	4000



HBD-ED Webbing sling, duplex construction, steel links on both ends

Made from polyester (PES), EN 1492-1 form Cr2, with capacity label.

Features

- Duplex construction, PU-starched, thermally fixed.
- With reeveable steel links.
- Woven tonnage stripes.
- Protection against hand injuries.
- Protection against cargo surface damage.
- Consistent pressure distribution onto pressure- and pull sensitive loads.
- UV-resistant, eliminating material ageing or embrittlement.
- Heat resistant up to +100°C.
- Moisture-resistant fabric, thus preventing frost damage (up to approx. -40°C).
- Low elongation (< 4 %).

INFO

HBD-ED - links are reeveable, webbing sling also applicable for use in choke hitch.

Technical data HBD-ED

Model	Colour code EN 1492	Capacity WLL, with one sling, straight pull kg	Capacity WLL, with one sling, choke hitch kg	Capacity WLL, with one sling, basket, angle β up to 7° kg	Capacity WLL, with one sling, basket, angle β 7°- 45° kg	Capacity WLL, with one sling, basket, angle β 45°- 60° kg	For webbing width mm	Link dimension HBD-ED b x d x t mm
HBD-01000-ED	violet	1000	800	2000	1400	1000	30	40 x 13 x 80
HBD-02000-ED	green	2000	1600	4000	2800	2000	60	75 x 16 x 125
HBD-03000-ED	yellow	3000	2400	6000	4200	3000	90	105 x 20 x 165
HBD-04000-ED	grey	4000	3200	8000	5600	4000	120	135 x 23 x 210

INFO

Other capacities upon request.

PU-SC

PU-protection sleeve, single and double-sided

Made from cut resistant polyurethane

With inner fabric insert to ease sliding of the sleeve on the webbing. Standard length 2 and 4 m.

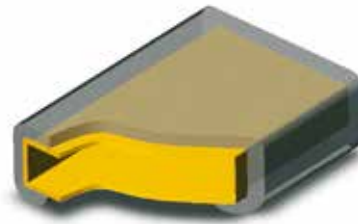

PU-protection sleeve single-sided,
PU-SC-1

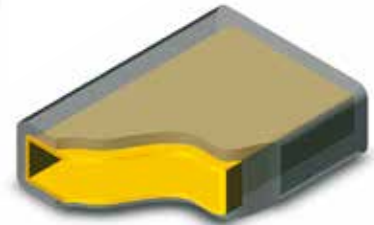

PU-protection sleeve double-sided,
PU-SC-2

INFO

Minimum length 1 m. Lengths over 4 m on request.

Technical data PU-SC, single-sided

Model	Art.-No.	For webbing width	Dimensions	Height
		mm	outside /inside mm	mm
PU-SC1-030	N39120011	30	50/40	22
PU-SC1-050	N39120001	50	70/60	22
PU-SC1-060	N39120002	60	80/70	22
PU-SC1-090	N39120004	90	110/100	22
PU-SC1-120	N39120012	120	145/135	22
PU-SC1-150	N39120007	150	170/160	22
PU-SC1-180	N39120008	180	200/190	22
PU-SC1-240	N39120009	240	260/250	31
PU-SC1-300	N39120010	300	330/320	31

Technical data PU-SC, double-sided

Model	Art.-No.	For webbing width	Dimensions	Height
		mm	outside /inside mm	mm
PU-SC2-030	N39130014	30	50/40	22
PU-SC2-050	N39130001	50	70/60	22
PU-SC2-060	N39130002	60	80/70	22
PU-SC2-090	N39130004	90	110/100	22
PU-SC2-120	N39130007	120	145/135	22
PU-SC2-150	N39130009	150	170/160	22
PU-SC2-180	N39130011	180	200/190	22
PU-SC2-240	N39130012	240	260/250	31
PU-SC2-300	N39130013	300	330/320	31

INFO

Double PU sleeves cannot be fitted subsequently on webbing slings with steel links. If required, state sleeve length when placing the webbing sling order.



PU-KSW PU-edge protector

Made from cut resistant polyurethane
With slots to allow easy attachment and fixing on the round sling.

Technical data PU-KSW

Model	Art.-No.	Diameter mm	Length mm	Suitable for round slings up to WLL kg
PU-KSW-30	N39160006	30	80	3000
PU-KSW-50	N39160007	50	125	5000



PU-SG Round sleeve

With fabric insert and PU-coating
Economical solution to protect webbing slings and round slings against wear caused by abrasion.

INFO

Not suitable for protection against sharp edges.

Technical data PU-SG

Model	Art.-No.	Width approx. mm	Diameter mm	Suitable for round slings up to WLL kg
PU-SG-040	N39140001	60	40	2000
PU-SG-052	N39140002	80	52	3000
PU-SG-075	N39140003	115	75	6000
PU-SG-090	N39140004	140	90	8000
PU-SG-110	N39140005	170	110	10000
PU-SG-150	N39140006	230	150	15000

PU-KSE-MAG

Edge protection profile with magnets

From colour coded polyurethane, extremely abrasive and cut resistant.



Technical data PU-KSE-MAG

Model	Art.-No.	Colour mm	For webbing width mm	Width mm	Number of magnets
PU-KSE-065-MAG	N39160029	green	60	100	2
PU-KSE-100-MAG	N39160030	yellow	90	135	4
PU-KSE-125-MAG	N39160031	grey	120	160	4
PU-KSE-150-MAG	N39160032	red	150	185	4
PU-KSE-200-MAG	N39160033	black	180	225	6
PU-KSE-300-MAG	N39160034	orange	300	330	8

PU-KSE

Edge protection profile

From colour coded polyurethane, extremely abrasive and cut resistant.



Technical data PU-KSE

Model	Art.-No.	Colour mm	For webbing width mm	Width mm
PU-KSE-065	N39160023	green	60	100
PU-KSE-100	N39160024	yellow	90	135
PU-KSE-125	N39160025	grey	120	160
PU-KSE-150	N39160026	red	150	185
PU-KSE-200	N39160027	black	180	225
PU-KSE-300	N39160028	orange	300	330

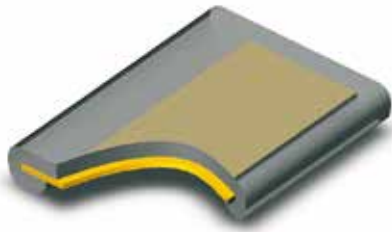

Coating single-sided,
PU-FB 1

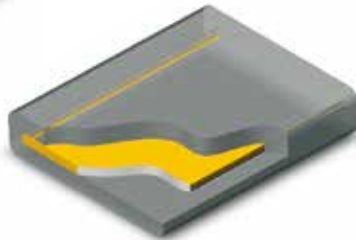

Coating double-sided,
PU-FB 2

PU-FB PU-coating, single and double-sided

Made from transparent polyurethane

Extremely wear and cut resistant. The coating is permanently fixed to the webbing and cannot be lost during usage.

Technical data PU-FB, single-sided

Model	Art.-No.	For webbing width mm	Width mm
PU-FB1-030	N39100009	30	40
PU-FB1-050	N39100001	50	60
PU-FB1-060	N39100002	60	70
PU-FB1-090	N39100003	90	100
PU-FB1-120	N39100004	120	130
PU-FB1-150	N39100005	150	160
PU-FB1-180	N39100006	180	190
PU-FB1-240	N39100007	240	250
PU-FB1-300	N39100008	300	310

Technical data PU-FB, double-sided

Model	Art.-No.	For webbing width mm	Width mm
PU-FB2-030	N39110009	30	40
PU-FB2-050	N39110001	50	60
PU-FB2-060	N39110002	60	70
PU-FB2-090	N39110003	90	100
PU-FB2-120	N39110004	120	130
PU-FB2-150	N39110005	150	160
PU-FB2-180	N39110006	180	190
PU-FB2-240	N39110007	240	250
PU-FB2-300	N39110008	300	310

Trucker Set

With each sport bag you receive:

- 2x Ratchet lashing, LC 250 daN, 25 mm, one-part, L=4.0 m
- 2x Ratchet lashing, LC 1000 daN, 35 mm, one-part, L=6.0 m
- 2x Ratchet lashing, LC 250 daN, 25 mm, two-part, double J hook, L=4.0 m
- 2x Ratchet lashing, LC 1000 daN, 35 mm, two-part, double J hook, L=6.0 m
- 4x Ratchet lashing, LC 2000 daN, 50 mm, two-part, double J hook, L=8.0 m
- 4x Edge protector, for 50 mm webbing width
- 4x Slip restraining mats, 250 x 100 x 8 mm

Art.-No.: N35500002

Minimum purchase: 2 bags



INFO

General information about load security

The varying forces, which can result in slipping, rolling, tilting or even lift-off of loads during transport, are regularly underestimated. Possible consequences are e.g. that the vehicle gets out of control, the driving cab is damaged, the vehicle even overturns and the falling load endangers others! The common assumption that very heavy loads do not require lashing security, is a fatal error. Lashing of loads may be performed by competent users (trained in theory and practice) only.

Some basic rules about load security with ratchet lashings

- Depending on the cargo, consideration shall be given to select an appropriate vehicle with adequate structures and lashing points.
- The load centre of gravity should be as low as possible and ideally positioned according to the load distribution plan of the vehicle.
- The permissible gross weight and loads per axle must not be exceeded.
- The load should be stored as close and low as possible and should not leave free space between load, front wall or side walls. Free spaces between the outer walls and the load should be stuffed where possible.
- Depending on the type of cargo, the driving speed should conform to the road and traffic situation as well as to the driving quality of the vehicle.
- Adverse friction values between cargo and loading area (oily metals, wet areas etc.) will considerably increase the requirement for a correct security of the load. Slip restraining mats will contribute to achieve a more economic and efficient load lashing security.
- Unstable cargo is very susceptible to tilting and in most cases has to be lashed extensively (calculation against slipping and tilting).
- Positive load lashing (e.g. supporting the cargo at front and side walls or with wedges or scantlings fixed on the loading platform) will contribute substantially to the stabilisation of the cargo and to reduction of additional lashing requirement.

Forces on cargo loads (EN 12195)

Truck and trailer loading (road transport) – Acceleration coefficients

During road transport the heaviest stresses on the load security equipment will occur during braking, lift-off of the load by vibration and impact as well as centrifugal forces in narrow curves.

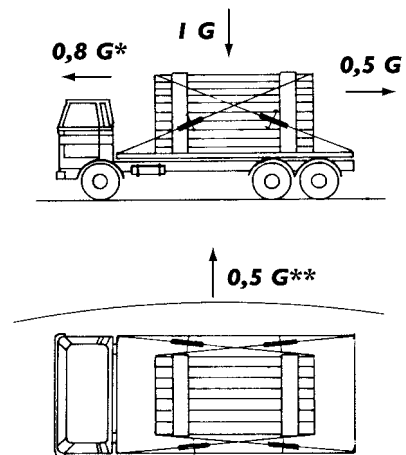

* The value for the longitudinal acceleration in combined traffic (lorry and/or trailer during rail transport) has to be calculated with 1G.

** 0.7 for tilting of instable cargo loads

Lashing methods

Over top lashing

Over top lashing consists of tensioning the lashings to the tension force so as to increase the friction force at the contact surface of the load to avoid any sliding of the load. Influence factors are the dimensions of the load, the acceleration values,

the dynamic friction factors as well as the lashing angle.

The calculation of lashing forces will give the required tension force of the lashing devices.

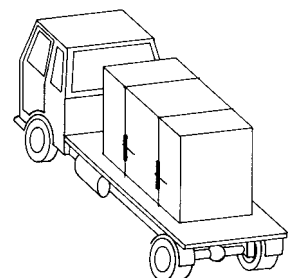

INFO

You will find the General Terms and Conditions at the end of the catalogue.

Please note the information on our training courses on page 4.

This user information presents a general overview regarding the application of web lashings and does not substitute the existing operating instructions for specific products!

Lashing operations with textile lashing equipment may be carried out by competent users (trained in theory and practice) only. When operated correctly, our textile lashings offer the highest degree of safety in line with long life expectancy and avoid damage to material and people.

Limitations of use

Temperature

Textile lashings in accordance with this part of the European standard EN 12195 are suitable for the following temperature areas:

- a) -40°C up to +80°C for polypropylene (PP)
- b) -40°C up to +100°C for polyamide (PA)
- c) -40°C up to +120°C for polyester (PES)

These temperature areas may change in chemical environments. In this case consult the manufacturer or supplier for advice.

A change of the ambient temperature during transport may influence the tension force of the textile lashing. The tension force should be checked after entering warm regions.

Chemicals

The resistance against chemical influences varies depending on the materials used for the textile lashing. Please observe the advice of the manufacturer, if the textile

lashings are subjected to chemicals. Also consider that the effect of the chemical influence will increase with rising temperatures. The resistance of synthetic fibre against chemical influences is summarised as follows:

- a) Polyamides are resistant against alkaline but affected by mineral acids.
- b) Polyester is resistant against mineral acids but affected by alkaline solutions.
- c) Polypropylene is hardly affected by acids and alkaline and is suited for applications that require high resistance against chemicals (except some organic solvents).
- d) Harmless acid or alkaline solutions may be concentrated by evaporation and lead to damages. Affected textile lashings have to be taken out of service immediately, thoroughly rinsed in cold water and dried in the open-air.

Operation in danger zones

During loading and unloading observe low hanging aerial contact lines.

Application advices

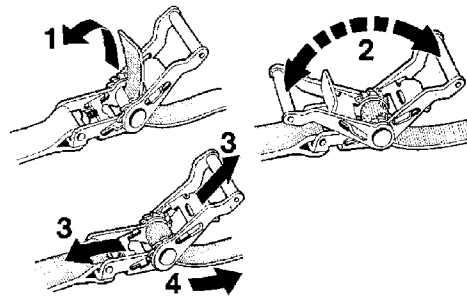

- Selection and use of textile lashings depend on the required tensioning force as well as the mode of application and type of cargo to be lashed. Size, form and weight of the cargo determine the correct choice in addition to the intended usage. For stability reasons, at least two lashing systems should be used for over top lashing and two pairs of lashing straps for diagonal lashing.
- The selected web lashing must be strong enough for the intended job and have the correct length for the type of lashing. Always consider adequate lashing practice: Attachment and removal of lashings should be planned before the start of the journey. In case of longer trips, partial unloadings must be considered. The number of lashings must be calculated as per EN 12195-1:2000. Over top lashing requires systems, which are labelled STF for over top lashing.
- On account of different characteristics and change of length under load, different lashings (e.g. lashing chains and web lashings) may not be used for lashing the same load. When using additional fittings or lashing devices, make sure that these correspond to the existing web lashing.
- During operation, flat hooks must be in contact with the full width of the hook mouth.

O
E
N

INFO

- Releasing of the lashing: Prior to releasing, make sure that the load stands safely (even without safety device) and does not endanger the operator by falling. Before departure check whether additional lashings will be required for further transportation after partial unloading has occurred.
This is also true for lashing elements which permit safe removal.
- Prior to unloading, the lashings must be released to an extent that the load stands freely.
- Make sure that the web lashing will not be damaged by the edges of the cargo. A visual inspection should be standard procedure before and after each usage.
- Only use textile lashings with legible identity labels.
- Textile lashings must not be overloaded:
The max. hand force of 500 N (50 daN on the label; 1 daN = approx. 1 kg) may be applied with one hand only. Do not use cheater bars or levers unless they are part of the lashing element.
- Knotted textile lashings must not be used.
- Damages to the identity labels should be avoided by keeping them away from the edges of the cargo.
- Textile lashings should be protected against friction and abrasion and damages by sharp edges by application of protective sleeves and/or edge protectors.

Labelling

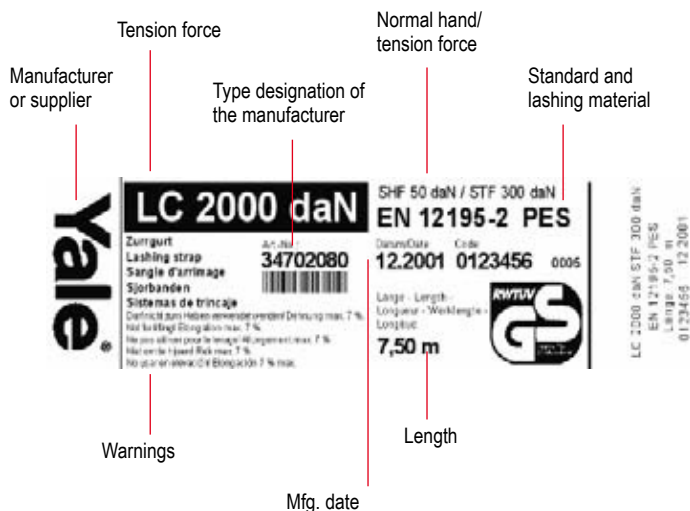

Maintenance and repair

Textile lashings may only be repaired if provided with legible identity labels. In case of accidental contact with chemicals, the web lashing has to be withdrawn from service and the manufacturer or supplier consulted for advice.

Criteria for disposal of textile lashings

Textile lashings must be withdrawn from service and returned for repair to the manufacturer in case of obvious defects. The following points are signs of possible damages:

Textile lashings:

- Cracks, cuts, notches and breaks in the load bearing strands and seams as well as deformations by heat;

Tensioning devices and fittings:

- Deformations, cracks, obvious signs of wear and corrosion.

The quantity of textile lashings has to be calculated according to EN 12195-1:2010

Only use lashing systems for over top lashing which show STF on the label. For easy identification of the required quantity of textile lashings or existing lashings needed for the cargo to be lashed refer to the following table, which has been calculated with friction coefficients of $\mu = 0.2$, $\mu = 0.4$ and $\mu = 0.6$ at various angles of elevation α .

- The calculation refers to situations with min. two, however max. ten textile lashings.
- Whenever possible, always use a slip resistant mat with a certified friction coefficient of 0.6!
- Always operate with the highest possible angle of elevation and lash as steep as possible!!!
- The friction coefficients are applicable for clean and dry surfaces, well covered from frost, ice and snow. In case of moisture refer to the direct lashing method or double the amount of textile lashings!

Friction factors according to EN 12195-1:2010

Combination of materials in the contact surface	Friction factor μ	when using a slip resistant mat
Cut timber against fabric base laminate/plywood	0.5	0.6
Cut timber against grooved aluminium	0.4	0.6
Cut timber against steel sheets	0.4	0.6
Cut timber against shrink films	0.3	0.6
Shrink films against fabric base laminate/plywood	0.4	0.6
Shrink films against grooved aluminium	0.4	0.6
Shrink films against steel sheets	0.4	0.6
Shrink films against shrink films	0.4	0.6
Cardboard box against cardboard box	0.5	0.6
Cardboard box against wooden pallet	0.5	0.6
Big bags against wooden pallet	0.4	0.6
Flat steel bars against cut timber	0.5	0.6
Unpainted corrugated sheets against cut timber	0.5	0.6
Painted corrugated sheets against cut timber	0.4	0.6
Unpainted corrugated sheets against unpainted corrugated sheets	0.3	0.6
Painted corrugated sheets against painted corrugated sheets	0.2	0.6

ONE

Number of required textile lashings for different cargo weights

- at different friction factors
- at different angles

Tension force of ratchet 300 daN at standard hand force of 50 daN according to EN 12195

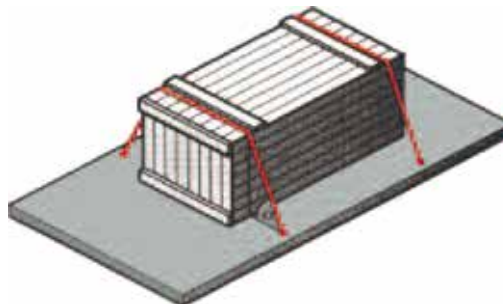

Applicable to textile lashings ZGR-50-2500 with LC 2500 daN and ZGR-50-2000 with LC 2000 daN

Cargo weight	Friction factor μ 0.20 Top angle			Friction factor μ 0.40 Top angle			Friction factor μ 0.60 Top angle		
	30°	60°	90°	30°	60°	90°	30°	60°	90°
1000 kg		10	9	7	4	3	3	2	2
2000 kg					8	7	6	3	3
3000 kg						10	9	5	4
4000 kg								7	6
5000 kg								8	7
6000 kg								10	9
7000 kg									10
8000 kg									
9000 kg									
10000 kg									

Cells without indication require more than 10 web lashings. In these cases a reasonable cargo securing can only be obtained by direct lashing method. Obstruction forces by cargo boards and form-fit locking devices have not been considered.



ZGK-25-250 Cambuckle lashing

Made from polyester (PES), EN 12195-2
25 mm - lashing capacity LC 250 daN.

Features

- Standard tension force STF 30 daN at standard hand force SHF 50 daN.
- Standard lengths 2 m, 4 m and 6 m.

INFO

Other lengths on request.

Technical data ZGK-25-250

Model	Art.-No.	Version	Lashing capacity LC daN	Webbing width mm	Length of lashing mm
ZGK-25-250-1	192067490	one-part	250	25	2000
ZGK-25-250-1	N35100240	one-part	250	25	4000
ZGK-25-250-1	N35100260	one-part	250	25	6000



ZGR-25-400 Ratchet lashing

Made from polyester (PES), EN 12195-2
25 mm - lashing capacity LC 400 daN.

Features

- Standard tension force STF 50 daN at standard hand force SHF 50 daN.
- Standard lengths 4 m and 6 m.



INFO

Other lengths on request.

Technical data ZGR-25-400

Model	Art.-No.	Version	Lashing capacity LC daN	Webbing width mm	Length of lashing mm
ZGR-25-400-1	N34100440	one-part	400	25	4000
ZGR-25-400-1	N34100460	one-part	400	25	6000
ZGR-25-400-2-SPH	N34700440	two-part - with double J hook	400	25	4000
ZGR-25-400-2-SPH	N34700460	two-part - with double J hook	400	25	6000

ZGR-25-500 Ratchet lashing

Made from polyester (PES), EN 12195-2
25 mm - lashing capacity LC 500 daN.

Features

- Standard tension force STF 100 daN at standard hand force SHF 50 daN.
- Standard lengths 2 m, 4 m and 6 m.



INFO

Other lengths on request.

Technical data ZGR-25-500

Model	Art.-No.	Version	Lashing capacity LC daN	Webbing width mm	Length of lashing mm
ZGR-25-500-1	192067491	one-part	500	25	2000
ZGR-25-500-1	N34100540	one-part	500	25	4000
ZGR-25-500-1	N34100560	one-part	500	25	6000
ZGR-25-500-2-SPH	192067503	two-part - with double J hook	500	25	2000
ZGR-25-500-2-SPH	N34700540	two-part - with double J hook	500	25	4000
ZGR-25-500-2-SPH	N34700560	two-part - with double J hook	500	25	6000



ZGR-35-1000 Ratchet lashing

Made from polyester (PES), EN 12195-2
35 mm - lashing capacity LC 1000 daN.

Features

- Standard tension force STF 150 daN at standard hand force SHF 50 daN.
- Standard lengths 4 m, 6 m and 8 m.

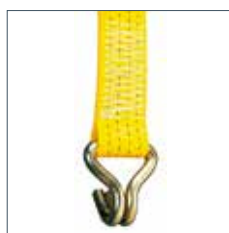

SPH - with double J hook



Technical data ZGR-35-1000

Model	Art.-No.	Version	Lashing capacity LC daN	Webbing width mm	Length of lashing mm
ZGR-35-1000-1	192067506	one-part	1000	35	4000
ZGR-35-1000-1	N34101060	one-part	1000	35	6000
ZGR-35-1000-1	N34101080	one-part	1000	35	8000
ZGR-35-1000-2-SPH	192067515	two-part - with double J hook	1000	35	4000
ZGR-35-1000-2-SPH	N34701060	two-part - with double J hook	1000	35	6000
ZGR-35-1000-2-SPH	N34701080	two-part - with double J hook	1000	35	8000

INFO

Other end fittings (hooks) and individual prints on webbing are available on request.

Other lengths on request.

ZGR-50-2000 Ratchet lashing

Made from polyester (PES), EN 12195-2
50 mm - lashing capacity LC 2000 daN.

Features

- Standard tension force STF 300 daN at standard hand force SHF 50 daN.
- Standard lengths 6 m, 8 m and 10 m.



GKH - with twisted snap hook

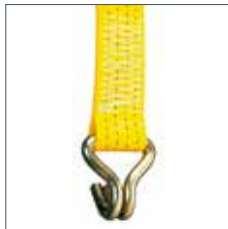

SPH - with double J hook

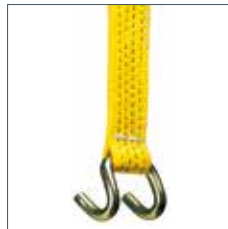

KLH - with claw hook

Technical data ZGR-50-2000

Model	Art.-No.	Version	Lashing capacity LC daN	Webbing width mm	Length of lashing mm
ZGR-50-2000-1	N34199999-166	one-part	2000	50	6000
ZGR-50-2000-1	N34102080	one-part	2000	50	8000
ZGR-50-2000-1	N34102010	one-part	2000	50	10000
ZGR-50-2000-2-GKH	N34202080	two-part - with snap hook	2000	50	8000
ZGR-50-2000-2-GKH	N34202010	two-part - with snap hook	2000	50	10000
ZGR-50-2000-2-KLH	N34302080	two-part - with claw hook	2000	50	8000
ZGR-50-2000-2-KLH	N34302010	two-part - with claw hook	2000	50	10000
ZGR-50-2000-FE-KLH	N34302005	Fixed end with ratchet and claw hook	2000	50	400
ZGR-50-2000-2-SPH	N34799999-248	two-part - with double J hook	2000	50	6000
ZGR-50-2000-2-SPH	N34702080	two-part - with double J hook	2000	50	8000
ZGR-50-2000-2-SPH	N34702010	two-part - with double J hook	2000	50	10000
ZGR-50-2000-FE-SPH	N34702005	Fixed end with ratchet and double J hook	2000	50	400

INFO

Other end fittings (hooks) and individual prints on webbing are available on request.

Other lengths on request.



ZGR-50-2500 Ratchet lashing

Made from polyester (PES), EN 12195-2
50 mm - lashing capacity LC 2500 daN.

Features

- Standard tension force STF 300 daN at standard hand force SHF 50 daN.
- Standard lengths 8 m and 10 m



GKH - with twisted snap hook



SPH - with double J hook

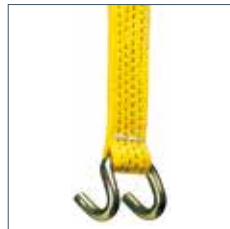

KLH - with claw hook

Technical data ZGR-50-2500

Model	Art.-No.	Version	Lashing capacity LC daN	Webbing width mm	Length of lashing mm
ZGR-50-2500-1	N34102580	one-part	2500	50	8000
ZGR-50-2500-1	N34102510	one-part	2500	50	10000
ZGR-50-2500-2-GKH	N34202580	two-part - with snap hook	2500	50	8000
ZGR-50-2500-2-GKH	N34202510	two-part - with snap hook	2500	50	10000
ZGR-50-2500-2-KLH	N34302580	two-part - with claw hook	2500	50	8000
ZGR-50-2500-2-KLH	N34302510	two-part - with claw hook	2500	50	10000
ZGR-50-2500-FE-KLH	N34302505	Fixed end with ratchet and claw hook	2500	50	400
ZGR-50-2500-2-SPH	N34702580	two-part - with double J hook	2500	50	8000
ZGR-50-2500-2-SPH	N34702510	two-part - with double J hook	2500	50	10000
ZGR-50-2500-FE-SPH	N34702505	Fixed end with ratchet and double J hook	2500	50	400

INFO

Other end fittings (hooks) and individual prints on webbing are available on request.

Other lengths on request.

ZGZ-G-75-5000 Ratchet lashing

Made from polyester (PES), EN 12195-2
75 mm - lashing capacity LC 5000 daN.

Features

- Standard tension force STF 500 daN at standard hand force SHF 50 daN.
- With long lever-transmission - pull ratchet
- Standard lengths 2 m and 4 m.



Long lever-transmission



SPH - with double J hook

Technical data ZGZ-G-75-5000

Model	Art.-No.	Version	Lashing capacity LC daN	Webbing width mm	Length of lashing mm
ZGZ-G-75-5000-1	192067448	one-part	5000	75	2000
ZGZ-G-75-5000-1	192067450	one-part	5000	75	4000
ZGZ-G-75-5000-2-SPH	192017853	two-part - with double J hook	5000	75	2000
ZGZ-G-75-5000-2-SPH	192017854	two-part - with double J hook	5000	75	4000

INFO

Other end fittings (hooks) and individual prints on webbing are available on request.

Other lengths on request.



ZGR-XL-50-2500 Ratchet lashing with long lever push ratchet

Made from polyester (PES), EN 12195-2
50 mm - lashing capacity LC 2500 daN.

Features

- Standard tension force STF 500 daN at standard hand force SHF 50 daN.
- Long lever ratchet with precise interlocking.
- With device for controlled release (securing against tipping load).
- Standard lengths 8 m and 10 m.

Technical data ZGR-XL-50-2500 with device for controlled release

Model	Art.-No.	Version	Lashing capacity LC daN	Webbing width mm	Length of lashing mm
ZGR-XL-50-2500-1	N34112580	one-part	2500	50	8000
ZGR-XL-50-2500-1	N34112510	one-part	2500	50	10000
ZGR-XL-50-2500-2-GKH	N34212580	two-part - with snap hook	2500	50	8000
ZGR-XL-50-2500-2-GKH	N34212510	two-part - with snap hook	2500	50	10000
ZGR-XL-50-2500-2-KLH	N34312580	two-part - with claw hook	2500	50	8000
ZGR-XL-50-2500-2-KLH	N34312510	two-part - with claw hook	2500	50	10000
ZGR-XL-50-2500-2-SPH	N34712580	two-part - with double J hook	2500	50	8000
ZGR-XL-50-2500-2-SPH	N34712510	two-part - with double J hook	2500 </td <td>50</td> <td>10000</td>	50	10000



Long lever ratchet
with precise interlocking. Device for controlled release (securing against tipping load).

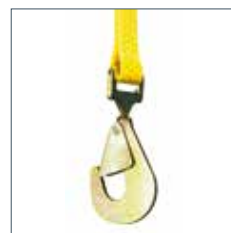

GKH - with twisted snap hook



SPH - with double J hook

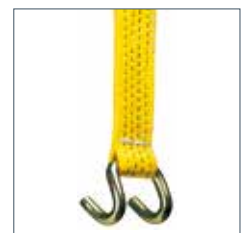

KLH - with claw hook

INFO

Other end fittings (hooks) and individual prints on webbing are available on request.

Other lengths on request.

ZGR-XLZ-50-2500 Ratchet lashing with long lever pull ratchet



Made from polyester (PES), EN 12195-2
50 mm - lashing capacity LC 2500 daN.

Features

- Standard tension force STF 500 daN at standard hand force SHF 50 daN.
- Long lever ratchet with precise interlocking.
- Ergonomic pull-type design.
- Standard lengths 8 m and 10 m.

INFO

Other end fittings (hooks) and individual prints on webbing are available on request.

Other lengths on request.

Technical data ZGR-XLZ-50-2500 ergonomic pull-type design

Model	Art.-No.	Version	Lashing capacity LC daN	Webbing width mm	Length of lashing mm
ZGR-XLZ-50-2500-1	N34132580	one-part	2500	50	8000
ZGR-XLZ-50-2500-1	N34132510	one-part	2500	50	10000
ZGR-XLZ-50-2500-2-GKH	N34232580	two-part - with snap hook	2500	50	8000
ZGR-XLZ-50-2500-2-GKH	N34232510	two-part - with snap hook	2500	50	10000
ZGR-XLZ-50-2500-2-KLH	N34332580	two-part - with claw hook	2500	50	8000
ZGR-XLZ-50-2500-2-KLH	N34332510	two-part - with claw hook	2500	50	10000
ZGR-XLZ-50-2500-2-SPH	N34732580	two-part - with double J hook	2500	50	8000
ZGR-XLZ-50-2500-2-SPH	N34732510	two-part - with double J hook	2500	50	10000

ZGA Automatic ratchet lashing

Made from polyester, EN 12195-2

Features

- With automatic ratchet.
- Quick and precise fixing of load.
- Stepless adjustment.
- Easy rolling of webbing strap.
- PVC coated S-Hook to protect the loading space.



Technical data ZGA

Model	Art.-No.	Version	Lashing capacity LC daN	Webbing width mm	Length of lashing mm
ZGA-25-300	N34799999-9681	two-part - with plastic coated S hooks	300	25	3000
ZGA-50-750	N34799999-11159	two-part - with double J hook	750	50	3000



ZGZB-RU-PU Ratchet base

Manufactured from cut resistant polyurethane.
Can also be used as edge protector.

Technical data ZGZB-RU-PU

Model	Art.-No.	For webbing width mm
ZGZB-RU-PU-50	N39150001	35 - 50
ZGZB-RU-PU-75	N39150002	75



ZGZB-KS-PP-50 Edge protector

Edge protector for lashing sensitive loads
(cardboard boxes etc.).

Technical data ZGZB-KS-PP-50

Model	Art.-No.	For webbing width mm
ZGZB-KS-PP-50	N39160003	50



ZGZB-KS-PP-70 Edge protector

Inherently stable edge protection, protects both load and
ratchet lashing.

Leg lengths 135 x 170 mm.

Technical data ZGZB-KS-PP-70

Model	Art.-No.	For webbing width mm
ZGZB-KS-PP-70	192020360	up to 70

ZGZB-KSP-PP Edge protector profile

Manufactured from polypropylene or recycled cardboard, to protect edges of loads. Length up to 6 m.



Technical data ZGZB-KSP-PP

Model	Art.-No.	Dimensions mm
ZGZB-KSP-PP	N39160004	190 x 190 x 20

ZGZB-ARM Slip restraining mats

Manufactured from compressed rubber granulate to achieve a defined friction coefficient of $\mu = 0.6$. Even if an emergency stop or evasive action is being taken – the cargo trucks or train wagons must not move. But only in very few cases the vehicle structure alone will offer sufficient load security.

For this reason, slip restraining devices should belong to the standard equipment of every professional transport. Slip restraining mats will decrease the danger which emanates from plain loading platforms. They will reduce the required total pre-tensioning forces during over top lashing of loads and will contribute – together with the textile lashings – that the loads will form a single unit with the vehicle or wagon.

The slip restraining effect will benefit especially those products, which do not stand a high surface pressure. The dangers resulting from incorrect load lashing practices are often underestimated. Acceleration forces in standard driving situations are close to the dead weight of the load.



INFO

The friction force FW of a slip restraining mat impedes load displacement and is physically explained as follows:

$FW = m \times G$
 $G =$ Weight force
 $m =$ Friction value

The difference between inertial force F and friction force FW is called securing force FS .

$FS = F - FW$

The securing force FS is the strength which has to be absorbed by the safety devices.

Technical data ZGZB-ARM

Model	Art.-No.	Dimensions mm
ZGZB-ARM-250-8	N39170001	1000 x 250 x 8



RLSP Load binders

Lashing capacity 4000 - 10600 daN

The load binder is a universal tool to restrain and secure loads and freight. Manual operation of the binder lever extends or retracts the threaded spindles. Tension is upheld by the self-locking threads.

The load binder is fitted with shortening hooks for direct attachment to chains or with clevis ends for use with existing fastening devices.

Technical data RLSP

Model	Art.-No.	Version	Lashing capacity LC daN	Weight kg
RLSP-08-ÖÖ	N43300015	Clevis	4000	3.6
RLSP-10-ÖÖ	N43300016	Clevis	6300	3.6
RLSP-13-ÖÖ	N43300017	Clevis	10600	3.8
RLSP-08-HH	N43300012	Shortening hooks	4000	4.5
RLSP-10-HH	N43300013	Shortening hooks	6300	5.5
RLSP-13-HH	N43300014	Shortening hooks	10600	8.4

Dimensions RLSP

Model	RLSP-08-ÖÖ	RLSP-10-ÖÖ	RLSP-13-ÖÖ	RLSP-08-HH	RLSP-10-HH	RLSP-13-HH
Chain size, mm	8	10	13	8	10	13
B1, mm	250	250	250	250	250	250
B2 min., mm	360	360	366	588	630	722
B2 max., mm	510	510	516	738	780	872
Ø E, mm	20	20	25	–	–	–
L, mm	230	230	360	190	230	360

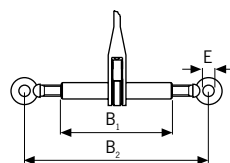

Load binder with protection against unscrewing, clevis acc. to EN 12195-3 on both ends.

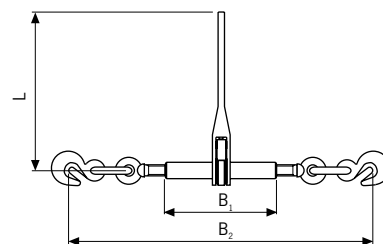

Load binder with protection against unscrewing, clevis or shortening hook with safety pin acc. to EN 12195-3 on both ends.

ASH Weld-on hooks

Capacity 1000 - 8000 kg

Weld-on hooks model ASH are universal attachments for use on trucks, excavators, low loaders and spreader beams, etc. The forged safety latch has high lateral stability and an ergonomic shape. Every weld-on hook has an identification number so that its history can be traced back through forging to the origin of the material.

The hook can be welded without any special preparation, e.g. prewarming.

The hook and safety latch are epoxy resin coated for added corrosion protection, the return spring is made from stainless steel.



Technical data ASH

Model	Art.-No.	Capacity kg	Weight kg
ASH 1	N41000104	1000	0.5
ASH 3	N41000035	3000	1.3
ASH 5	N41000036	5000	2.4
ASH 8	N41000037	8000	3.6

Dimensions ASH

Model	ASH 1	ASH 3	ASH 5	ASH 8
Seam density a, mm	4	6	7	8 - 9
L1 x B1, mm	90 x 25	130 x 35	160 x 45	170 x 50
B2, mm	19	26	30	40
C, mm	24	32	40	51
H1, mm	6	10	12	12
H2, mm	76	117	121	142
L2, mm	22	29	47	52

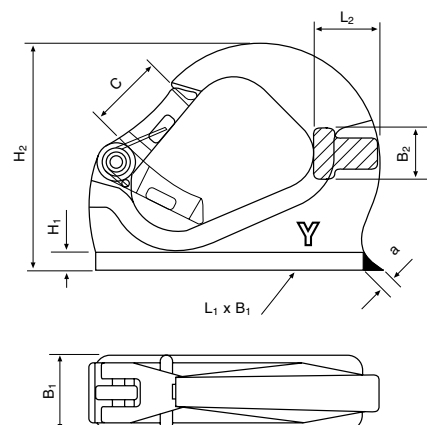



RSE-S Yaletex Entertainment round slings

Made from polyester (PES), EN 1494-2 with extra sturdy stitchless protection sleeve, with capacity label.

- With black single sleeve, PU-starched and thermally fixed
- Identification label sewn into a transparent protective cover
- Heat resistant up to +100 °C

Technical data RSE-S

Model	Art.-No.	WLL kg	Width mm	Length m
RSE-S-01000	N33101007	1000	46	0.5
RSE-S-01000	N33101012	1000	46	1.0
RSE-S-01000	N33101017	1000	46	1.5
RSE-S-01000	N33101022	1000	46	2.0
RSE-S-01000	N33101027	1000	46	2.5
RSE-S-01000	N33101032	1000	46	3.0
RSE-S-01000	N33101042	1000	46	4.0
RSE-S-01000	-	1000	46	5.0
RSE-S-01000	-	1000	46	6.0
RSE-S-02000	N33102007	2000	46	0.5
RSE-S-02000	N33102012	2000	46	1.0
RSE-S-02000	N33102017	2000	46	1.5
RSE-S-02000	N33102022	2000	46	2.0
RSE-S-02000	N33102027	2000	46	2.5
RSE-S-02000	N33102032	2000	46	3.0
RSE-S-02000	N33102042	2000	46	4.0
RSE-S-02000	N33102052	2000	46	5.0
RSE-S-02000	N33102062	2000	46	6.0

RSE-SRS Yaletex Entertainment round slings with steel rope inserts

BG-certified according to DGUV 17 (former BGV C1) according to EN 1492-2, EN 13414-1/A1 and EN 13414-3 appendix A

- Steel rope with loose polyester cover
- With black single sleeve, PU-starched and thermally fixed
- Identification label sewn into a transparent protective cover
- Control window for checking the rope core
- Minimum edge radius 6 mm
- Proven heat resistance from -40 °C up to +150 °C
- The steel cable insert eliminates the requirement of DGUV 17 for a secondary safety device



Technical data RSE-SRS

Model	Art.-No.	WLL kg	Width mm	Length m
RSE-SRS-01000	N33601005	1000	46	0.5
RSE-SRS-01000	N33601010	1000	46	1.0
RSE-SRS-01000	N33601015	1000	46	1.5
RSE-SRS-01000	N33601020	1000	46	2.0
RSE-SRS-01000	N33601025	1000	46	2.5
RSE-SRS-01000	N33601030	1000	46	3.0
RSE-SRS-01000	N33601040	1000	46	4.0
RSE-SRS-02000	N33602005	2000	46	0.5
RSE-SRS-02000	N33602010	2000	46	1.0
RSE-SRS-02000	N33602015	2000	46	1.5
RSE-SRS-02000	N33602020	2000	46	2.0
RSE-SRS-02000	N33602025	2000	46	2.5
RSE-SRS-02000	N33602030	2000	46	3.0
RSE-SRS-02000	192065769	2000	46	4.0

PU-KSW-30-S Yaletex Entertainment round slings edge protector

Made of cut-resistant polyurethane. With slots for easy mounting and fixing on the round sling.



Technical data PU-KSW-30-S

Model	Art.-No.	Diameter mm	Length m
PU-KSW-30-S	N39160022	30	80



HSE-TH Yaletex Theater load belts

Endlessly stitched, with a 50 mm loop, black.

- With black single sleeve, PU-starched and thermally fixed
- WLL 0.5 t, made from polyester (PES)
- According to EN 1492-1 form A2
- Heat resistant up to +100 °C

Technical data HSE-TH

Model	Art.-No.	WLL kg	Width/Loop Ø mm	Length m
HSE-TH-500	N31600503	500	25/50	0.35
HSE-TH-500	N31600505	500	25/50	0.5
HSE-TH-500	192050762	500	25/50	0.7
HSE-TH-500	N31600510	500	25/50	10
HSE-TH-500	N31600515	500	25/50	1.5



ZGK-S-25-0250-1 Entertainment cambuckle lashings

Made from polyester (PES), EN 12195-2, 25 mm, lashing capacity LC 250 daN, standard tension force STF 30 daN at standard hand force SHF 50 daN.

Technical data ZGK-S-25-0250-1

Model	Art.-No.	Version	Lashing capacity LC daN	Webbing width mm	Length m
ZGK-S-25-0250-1	N35100242	one-part	250/500	25	4.0
ZGK-S-25-0250-1	N35100262	one-part	250/500	25	6.0

ZGR-S-25-0400

Entertainment cambuckle lashings

Made from polyester (PES), EN 12195-2, 25 mm, lashing capacity LC 400 daN, standard tension force STF 80 daN at standard hand force SHF 50 daN.



Technical data ZGR-S-25-0400

Model	Art.-No.	Version	Lashing capacity LC daN	Webbing width mm	Length m
ZGR-S-25-0400-1	N34100442	one-part	400/800	25	4.0
ZGR-S-25-0400-1	N34100462	one-part	400/800	25	6.0
ZGR-S-25-0400-2-SPH	N34700442	two-part with double J hook	400/800	25	4.0
ZGR-S-25-0400-2-SPH	N34700462	two-part with double J hook	400/800	25	6.0

ZGR-S-25-0500

Entertainment ratchet lashings

Made from polyester (PES), EN 12195-2, 25 mm, lashing capacity LC 500 daN, standard tension force STF 100 daN at standard hand force SHF 50 daN.



Technical data ZGR-S-25-0500

Model	Art.-No.	Version	Lashing capacity LC daN	Webbing width mm	Length m
ZGR-S-25-0500-1	N34100542	one-part	500/1000	25	4.0
ZGR-S-25-0500-1	N34100562	one-part	500/1000	25	6.0
ZGR-S-25-0500-2-SPH	N34700542	two-part with double J hook	500/1000	25	4.0
ZGR-S-25-0500-2-SPH	N34700562	two-part with double J hook	500/1000	25	6.0



ZGR-S-35-1000

Entertainment ratchet lashings

Made from polyester (PES), EN 12195-2, 35 mm, lashing capacity LC 1000 daN, standard tension force STF 150 daN at standard hand force SHF 50 daN.

Technical data ZGR-S-35-1000

Model	Art.-No.	Version	Lashing capacity LC daN	Webbing width mm	Length m
ZGR-S-35-1000-1	N34101062	one-part	1000/2000	35	6.0
ZGR-S-35-1000-1	N34101082	one-part	1000/2000	35	8.0
ZGR-S-35-1000-2-SPH	N34701062	two-part with double J hook	1000/2000	35	6.0
ZGR-S-35-1000-2-SPH	N34701082	two-part with double J hook	1000/2000	25	8.0



ZGR-S-50-2500

Entertainment ratchet lashings

Made from polyester (PES), EN 12195-2, 50 mm, lashing capacity LC 2500 daN, standard tension force STF 300 daN at standard hand force SHF 50 daN.

Technical data ZGR-S-50-2500

Model	Art.-No.	Version	Lashing capacity LC daN	Webbing width mm	Length m
ZGK-S-50-2500-1	N34102582	one-part	2500/5000	50	8.0
ZGK-S-50-2500-1	N34102512	one-part	2500/5000	50	10.0
ZGR-S-50-2500-2-SPH	N34702582	two-part with double J hook	2500/5000	50	8.0
ZGR-S-50-2500-2-SPH	N34702512	two-part with double J hook	2500/5000	50	10.0

GTG

Gas cylinder transport harness made from polyester (PES)

Gas cylinder transport harnesses are the simple and cost-effective way of safely transporting gas cylinders at height (e.g. with a winch).

Four different models with diameters of 14 cm, 25 cm or 30 cm cover a wide range of applications.

Features

- 2 pairs of eyes for transporting gas cylinders of different heights.
- GTG K 14 and GTG K 25 with Velcro fastener for easier loading of the harness.
- Easy handling due to low weight.
- UV-resistant, no material ageing or embrittlement
- Gentle handling of the gas cylinders.
- Moisture-resistant fabric, thus preventing frost damage.
- Low elongation (<4%)



INFO

Yale hoists and trolleys are not designed for passenger elevation applications and must not be used for this purpose.

Technical data GTG and GTG K

Model	Art.-No.	Capacity WLL kg	Height cm	Circumference cm	Diameter cm	Number of eyes
GTG K 14	192083222	50	150	44	14	2+2
GTG 25	192020407	200	150	80	25	2+2
GTG K 25	192042091	200	150	80	25	2+2
GTG 30	192053794	200	150	95	30	2+2