

TABLE OF CONTENTS

FORWARD	1
Section 1 INTRODUCTION	2
1.1 General.....	2
1.2 Receiving.....	2
Section 2 INSTALLATION	3
2.1 Location.....	3
2.2 Positioning.....	4
<i>Figure 1: IMPULSE•G+ Clearance Requirements</i>	4
2.3 Overall Dimensions/Weights.....	5
<i>Figure 2: Physical Dimensions</i>	5
2.4 Specifications.....	6
Section 3 WIRING	7
3.1 Main AC Power Interconnections.....	7
<i>Figure 3: IMPULSE•G+ Main Power Circuit Connections</i>	7
3.1.1 Input Fuse or Circuit Breaker Selection and Power Circuit Wire Size.....	8
<i>Table 1: MCCB, Fuse and Power Wire Selection</i>	8
3.1.2 Grounding.....	9
<i>Figure 4: Grounding of Multiple IMPULSE•G+ Units</i>	9
3.1.3 Motor Thermal Overload Protection.....	9
3.1.4 Motor Brake Magnetic Contactor.....	10
3.1.5 Mainline Magnetic Contactor.....	10
3.1.6 Special Warnings for Power Semi-Conductors.....	10
3.2 Control Circuit Interconnections.....	11
<i>Figure 5: Recommended Control Circuit Interconnections</i>	11
3.2.1 Wire Size.....	12
3.2.2 Direction and Speed Selection Input Commands.....	12
3.2.3 Motor Brake Interlock Output Command.....	12
3.2.4 Motor Thermal Overload.....	13
3.2.5 Fault Relay Output Contacts.....	13
3.2.6 Additional Wiring Precautions.....	13
<i>Table 2: R-C Surge Absorber Specifications</i>	14
<i>Table 3: AC Reactor Specifications</i>	14
Section 4 DIGITAL OPERATOR	16
4.1 Operator Layout & Key Functions.....	16
4.2 Programming Mode Key Functions.....	18
4.3 Local Operator Control Mode Key Functions.....	20

Section 5 TO BEGIN PROGRAMMING 22

5.1 What is a "CONSTANT"?.....22

5.2 Access to various Constant modes.....22

 5.2.1 Multi-step speed REFERENCE constants (An constants).....23

 5.2.2 ACTIVE Mode (Bn) Constants.....24

 5.2.3 Sn-01 Data Table.....25

 5.2.4 SYSTEM Mode (Sn) Constants.....26

 5.2.5 CONTROL(Cn) Constants.....28

 5.2.6 MONITOR Mode (Un) Constants.....30

5.3 Programming Enable--Defeating Automatic Keypad Lockout™.....31

5.4 Simple Programming.....32

 5.4.1 How to Change the Minimum Operating Speed32

 5.4.2 How to Change Any of the Speed Settings (An Constants)33

 5.4.3 How to Change the Accel (Decel) Time.....34

Section 6 CONTROL FLEXIBILITY 36

6.1 Speed Control Method Definitions (Set by Constant Sn-10)36

 6.1.1 Multi-Step Speed Control Method36

 6.1.1.1 Input Terminal Status/Output Frequency Operation.....37

 6.1.2 Infinitely Variable Speed Control Method (2-Step Type).....38

 6.1.2.1 Input Terminal Status/ Output Frequency Operation.....39

 6.1.3 Infinitely Variable Speed Control Method (3-Step Type).....40

 6.1.3.1 Input Terminal Status/ Output Frequency Operation.....41

6.2 Stopping Method Definitions.....42

 6.2.1 Immediate Stop at STOP Command.....42

 6.2.2 Decelerate at STOP Command.....42

Section 7 SETTING RECIPES for SPECIFIC SPEED CONTROL METHODS 45

7.1 Multi-Step Speed Control Method.....45

 7.1.1 Control Circuit Wiring Diagram for Multi-Step Speed Control.....45

 7.1.2 Control Circuit Input Sequence for Multi-Step Speed Control.....46

 7.1.3 Suggested Values for Multi-Step Speed Points.....46

 7.1.4 Suggested Settings for Other Constants (Multi-Step Speed Control).....47

7.2 Infinitely Variable Speed Control Method (2-Step Type).....49

 7.2.1 Control Circuit Wiring Diagram for 2-Step Infinitely Variable.....49

 7.2.2 Input Terminal Status/ Output Frequency for 2-Step Infinitely Variable.....50

 7.2.3 Suggested Settings for Other Constants (for 2-Step Infinitely Variable).....51

7.3 Infinitely Variable Speed Control Method (3-Step Type).....53

 7.3.1 Control Circuit Wiring Diagram for 3-Step Infinitely Variable.....53

 7.3.2 Input Terminal Status/Output Frequency for 3-Step Infinitely Variable.....54

 7.3.3 Suggested Settings for Other Constants (for 3-Step Infinitely Variable).....55

Section 8 ADDITIONAL SETTINGS and ADJUSTMENTS 56

8.1 Acceleration Time..... 56
 8.2 Deceleration Time..... 57
 8.3 Selection of Proper Volts/Hertz (V/F) Pattern..... 58
 8.3.1 The Importance of the Proper Volts/Hertz (V/F) Relationship..... 58
 8.3.2 Programming of Input Voltage into Inverter..... 60
 8.3.3 Programming of Volts/Hertz (V/F) Pattern for Horizontal Motions..... 61
 8.3.4 Programming of Volts/Hertz (V/F) Pattern for Mechanical Load
 Brake Hoist Motions..... 61
 8.4 To Enable/Disable Electronic Motor Thermal Overload Protection..... 62

Section 9 SPECIAL FEATURES of IMPULSE•G+ 66

9.1 Simple Safety Features of **IMPULSE•G+**..... 66
 9.1.1 STOP Button Operation..... 66
 9.1.2 RUN Button Operation..... 67
 9.1.3 Automatic Keypad Lockout™..... 67
 9.2 Special Safety Features of **IMPULSE•G+**..... 68
 9.2.1 Load Check™ Function for Hoisting..... 68
 9.2.1.1 Underlying Ideas of Load Check Function..... 68
 9.2.1.2 Diagram of Output Current Vs. Output Frequency..... 68
 9.2.1.3 Load Check Detection Method Timing Chart..... 69
 9.2.1.4 Load Check Flow Chart..... 70
 9.3 Minimum Base Block Time for Conical Rotor Motor Hoists..... 71
 9.3.1 Timing Chart for Cn-23 Function..... 71
 9.3.2 Programming Method 71
 9.4 Automatic Alternate Accel/Decel Time Changeover..... 72
 9.4.1 Background of Function..... 72
 9.4.2 Programming Method..... 72
 9.4.3 Timing Chart..... 72
 9.5 Automatic Alternate Decel Time Changeover..... 73
 9.5.1 Background of Function..... 73
 9.5.2 Programming Method..... 73
 9.5.3 Timing Chart..... 73
 9.6 Quick Stop™..... 74
 9.6.1 Background of Quick Stop Function..... 74
 9.6.2 Quick Stop Programming Method..... 74
 9.6.3 Quick Stop Timing Chart..... 74
 9.7 Reverse Plug Simulation™..... 75
 9.7.1 Background of Reverse Plug Simulation..... 75
 9.7.2 Reverse Plug Simulation Programming Method..... 75
 9.7.3 Reverse Plug Simulation Timing Chart..... 75
 9.8 End of Travel Limit™..... 76
 9.8.1 Background of End of Travel Limit Function..... 76
 9.8.2 End of Travel Limit Programming Method..... 76
 9.8.3 End of Travel Limit Timing Chart..... 76

9.9 Slip Compensation.....	77
9.9.1 Slip Compensation Programming Method.....	77
9.10 Swift Lift™ Overspeed Operation.....	78
9.10.1 Background of Function.....	78
9.10.2 Programming Method.....	78
9.10.3 Swift Lift Flow Chart.....	79
9.11 Phase Loss Detection.....	80
9.11.1 Programming Method.....	80

Section 10. PRECAUTIONARY CHECKS BEFORE TEST/RUN OPERATION 81

10.1 Checks Before Test Run/Operation.....	81
--	----

Section 11. MAINTENANCE 82

11.1 Maintenance.....	82
-----------------------	----

Section 12. TROUBLESHOOTING 101 - THE BASICS OF TROUBLESHOOTING 83

12.1 Troubleshooting 101 - Where to Begin.....	83
12.1.1 Troubleshooting for Symptom #1 - Equipment Will Not Operate.....	83
12.1.2 Troubleshooting for Symptom #2 - Equipment Operates, But Operation is Either Intermittent Or Not Acceptable.....	85
12.2 Possible Solutions to Common Fault Codes.....	86
12.3 General Description and Listing of all Possible Fault Codes.....	87

Appendix I. RECOMMENDED WIRING PRACTICES 88

Appendix II. RECOMMENDED MOTOR LEAD CABLE SIZING 90

FORWARD

THANK YOU !

We at ELECTROMOTIVE SYSTEMS, INC. appreciate your purchase of this **IMPULSE•G+** adjustable frequency drive. When properly installed, operated and maintained, the **IMPULSE•G+** will provide a lifetime of reliable operation. It is **MANDATORY** that the person who operates, inspects, and maintains this equipment thoroughly read and understand this manual.

This instruction manual has been designed to serve as a self contained guide for the proper installation, operation, and maintenance of the **IMPULSE•G+** adjustable frequency drive. If you require additional assistance, please feel free to contact either your local supplier or ELECTROMOTIVE SYSTEMS.

NOTE: Throughout this instruction manual, **IMPULSE•G+** will be referred to as both an Adjustable Frequency Drive (or simply Drive) or as an Inverter. All references to either are to be construed as one in the same.

DANGER ! Do NOT touch any circuit components while AC main power is on or immediately after the main AC power is disconnected from the unit. You must first wait until the red "CHARGE" lamp (always located just left of the main power terminal strip) is extinguished. It may take as long as 10 minutes for the charge on the main DC bus capacitors to drop to a safe level. Failure to adhere to this warning could result in serious injury.

© 1991 ELECTROMOTIVE SYSTEMS, INC.

All rights reserved. The above notice applies to all copyrighted materials included with this product, including, but not limited to, this manual and the software embodied within the product. This manual is intended for the sole use of the person to whom it was provided, and any unauthorized distribution of the manual or dispersal of its contents is strictly forbidden. This manual may not be reproduced in whole or in part by any means whatsoever without the expressed written permission of ELECTROMOTIVE SYSTEMS, INC..

SECTION 1: INTRODUCTION

1.1 General

IMPULSE•G+ represents a new age in adjustable frequency motor controls utilizing state-of-the-art IGBT (Insulated Gate Bi-Polar Transistor) output transistors and 16 bit microprocessor-based digital control of all functions and settings. All modifications or adjustments are easily performed using the built-in keypad.

IMPULSE•G+ incorporates a high performance Pulse Width Modulated (PWM) design generating a variable voltage- variable frequency output that closely approximates a sinusoidal current waveform to allow variable speed control of any conventional squirrel cage, three-phase induction motor.

IMPULSE•G+ is a *unique* hardware & software configuration specifically designed for application to crane, hoist, and monorail systems. This product is the direct result of over 7 years experience in applying adjustable frequency drives to satisfy the demanding requirements of this market. Following are a few of the pertinent features:

- * Easily configured for conventional pendant station control.
- * Can be directly interfaced with 120 VAC control signals.
- * User selectable speed control methods, multi-step or infinitely variable.
- * User selectable braking methods, controlled decel, coast, or immediate stop (using motor brake).
- * SWIFT LIFT™ for high speed operation at light load conditions.
- * REVERSE PLUG SIMULATION™ for quick response reverse plugging operation.
- * QUICK STOP™ for rapid deceleration at stop command only.
- * End of travel limit input.
- * LOAD CHECK™ built-in load detection system.
- * Alternate Voltage/Frequency (V/F) output patterns for raising/lowering improves hoisting operation.
- * Custom Hardware suitable for 200-240/380-480VAC (+/-10%) operation
- * IGBT output devices for improved torque performance in the low speed ranges and quieter operation.

1.2 Receiving

This unit has been put through demanding tests at the factory prior to shipment. Before unpacking please check the following:

- * Please read specifications sticker on outside of box. Compare the description of the product found on that sticker with the description of the product on your purchase order.
- * Inspect for damage sustained in transit (damage to carton may be indicative of unit damage).

1.2 Receiving (Continued)

After unpacking, please check the following:

- * Specifications sticker located on the side of the unit matches your application requirement (i.e. current and voltage).
- * Check to see that all electrical connections and screws are secure.
- * Verify that there is no visible damage to any of the components.

If any part of the **IMPULSE•G+** is damaged or lost, immediately notify both the freight carrier and ELECTROMOTIVE SYSTEMS, INC.

Special Note: If you purchased this **IMPULSE•G+** as part of an ELECTROMOTIVE SYSTEMS, pre-engineered, **TCONTROL®** motor control panel you should skip Sections 2 and 3 and proceed directly to Section 4.

SECTION 2: INSTALLATION

2.1 Location

Proper location of the **IMPULSE•G+** is imperative to achieve optimum performance and a normal operating life. These units should always be installed in areas where the following conditions exist:

- * Ambient operating temperature: + 14 ~ +104 °F (-10 ~ +40 °C)
- * Protected from rain and moisture.
- * Protected from corrosive gases or liquids.
- * Sheltered from direct sunlight.
- * Free from metallic particles or excessive airborne dust.
- * Free from excessive vibration (see specification sheet).

2.2 Positioning

For cooling and maintenance purposes, make sure that there is sufficient clearance around the **IMPULSE•G+** whether it is enclosed in a cabinet or not, as shown in Figure 1. To maintain effective air flow/cooling, **IMPULSE•G+** must be installed with heatsink ribs oriented vertically.

Figure 1
IMPULSE•G+ Clearance Requirements

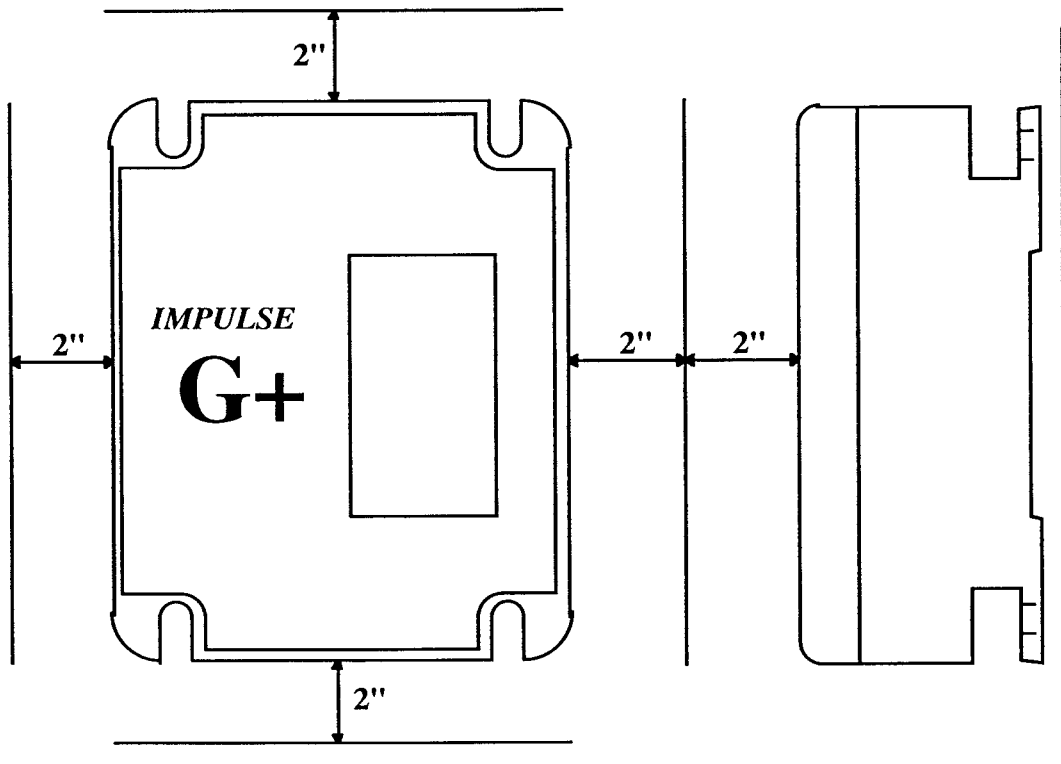

2.3 Overall Dimensions (in inches)/ Weight (in lbs.):

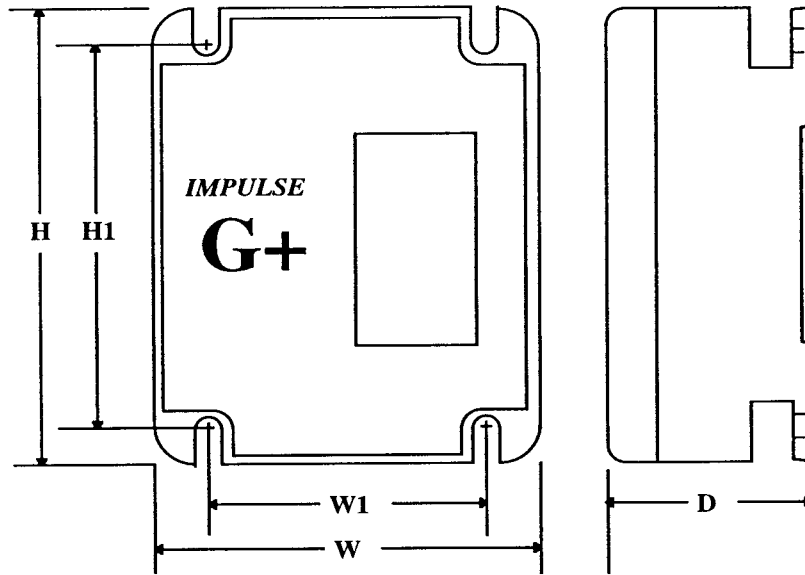

MODEL NO.	H	H1	W	W1	D	Hole	Weight
230AFD1-G+	12	11.2	8.1	7.1	5.1	0.31	8.8
230AFD2-G+					6.5		15.4
230AFD3-G+					7.9		22
230AFD5-G+					7.9		41.9
230AFD7.5-G+	13.9	13.2	9.8	7.9	10.1	0.31	66.1
230AFD10-G+	19.7	19.1					
230AFD15-G+	21.7	21.1					
230AFD20-G+	21.7	21.1	12.8	10.8	10.1	0.31	66.1
230AFD25-G+							
230AFD30-G+							
230AFD30-G+							
460AFD1-G+	13.9	13.2	8.1	7.1	6.5	0.31	15.4
460AFD2-G+					7.9		22
460AFD3-G+					7.9		22
460AFD5-G+					7.9		22
460AFD7.5-G+	19.7	19.1	9.8	7.9	11.6	0.31	48.5
460AFD10-G+							
460AFD15-G+							
460AFD20-G+	21.7	21.1	12.8	10.1	10	0.31	70.5
460AFD25-G+							
460AFD30-G+							
460AFD40-G+							
460AFD50-G+	28.6	27.8	13.8	8.8	11.1	0.39	99.2
460AFD60-G+							

Specifications - **IMPULSE•G+**

	Input Voltage	200 to 230 Volts												380 to 480 Volts											
	Inverter Model #	230AFD(Horsepower Rating)-G+												460AFD(Horsepower Rating)-G+											
Output Characteristics	Horsepower *	1	2	3	5	7.5	10	15	20	25	30	1	2	3	5	7.5	10	15	20	25	30	40	50	60	
	kW	.75	1.5	2.2	3.7	5.5	7.5	11	15	18.5	22	.75	1.5	2.2	3.7	5.5	7.5	11	15	18.5	22	30	37	45	
	Max. cont. current	4.8	6.4	9.6	16	24	32	48	64	80	96	2.6	4.0	4.8	8	12	16	24	32	40	48	64	80	96	
	Maximum Output Voltage	3-Phase 200/208/220/230V (Proportional to Input Voltage)												3-Phase 380/400/415/440/460/480V (Proportional to Input Voltage)											
	Output Frequency Range	1.5 to 400 Hz (Maximum frequency for V/f pattern is programmable between 50 and 400 Hz)																							
Power Supply	Rated Input Voltage and Frequency	3-Phase 200/208/220/230V 50/60 Hz												3-Phase 380/400/415/440/460/480V 50/60 Hz											
	Allowable Voltage Fluctuation	± 10 %																							
	Allowable Frequency Fluctuation	± 5 %																							
Control Characteristics	Control Method	Sine Wave PWM																							
	Control Commands	Commanded by a 16 bit micro-processor through a fully programmable EPROM																							
	Frequency Control Range	40 to 1 (Frequency range that allows for a minimum 150 % torque)																							
	Frequency Accuracy	Digital command: 0.01 %(-10 to 40 C) Analog Command: 0.1%(25 ± 10 C)																							
	Frequency Setting Signal	Digital: Dry circuit contact closure Analog: 0 to 10 VDC (20 kohm), 4-20 mA (250 ohm)																							
	Braking Torque	Approx. 20 % (up to approx. 170 % can be obtained with optional dynamic braking resistor package)																							
	Accel/Decel Time	0.1 to 6000 sec. (Accel/Decel set independently)																							
No. of V/f Patterns	16 patterns specifically tailored for overhead material handling applications																								
Protective Functions	Motor Overload Protection	Provided by electronic thermal overload circuit																							
	Instantaneous Overcurrent	Inverter output is shut off at 200 % rated current																							
	Fuse Blown Protection	Inverter output is shut off if DC bus fuse is blown																							
	Overload	150 % of horizontal motion continuous output current rating for one minute																							
	Overvoltage	If DC bus voltage exceeds 400V												If DC bus voltage exceeds 800V											
	Undervoltage	If DC bus voltage drops to 210V												If DC bus voltage drops to 420V											
	Fin Overheat	Provided by thermostat																							
	Ground Fault	Provided by electronic circuit																							
Power Charge Indication	Charge lamp stays ON until DC bus voltage drops to 50V																								
Environmental Conditions	Location	Indoor (Protected from corrosive gases and dust)																							
	Ambient Temp.	- 10 to 40 C																							
	Humidity	90 % RH (non-condensing)																							
	Vibration	1 G less than 20 Hz, up to 0.2 G at 20 to 50 Hz																							

* Horsepower is based on standard NEMA B 4-pole squirrel cage induction motor.

Special Note: If you purchased this **IMPULSE•G+** as part of an **ELECTROMOTIVE SYSTEMS**, pre-engineered, **TCONTROL** motor control panel you should skip Section 3 and proceed directly to Section 4.

Section 3 provides **ELECTROMOTIVE SYSTEMS'** recommendations regarding the power and control circuit wiring of the **IMPULSE•G+** unit. We must emphasize, however, that these are only *suggestions*. **You must follow the NEC and your local applicable codes whenever making any of the interconnections to this unit.**

Finally, please read **ALL** the sub-sections of Section 3 before beginning any of the unit wiring.

SECTION 3: WIRING

3.1 Main AC Power Interconnections

Figure 3: IMPULSE•G+ Main Power Circuit Connections

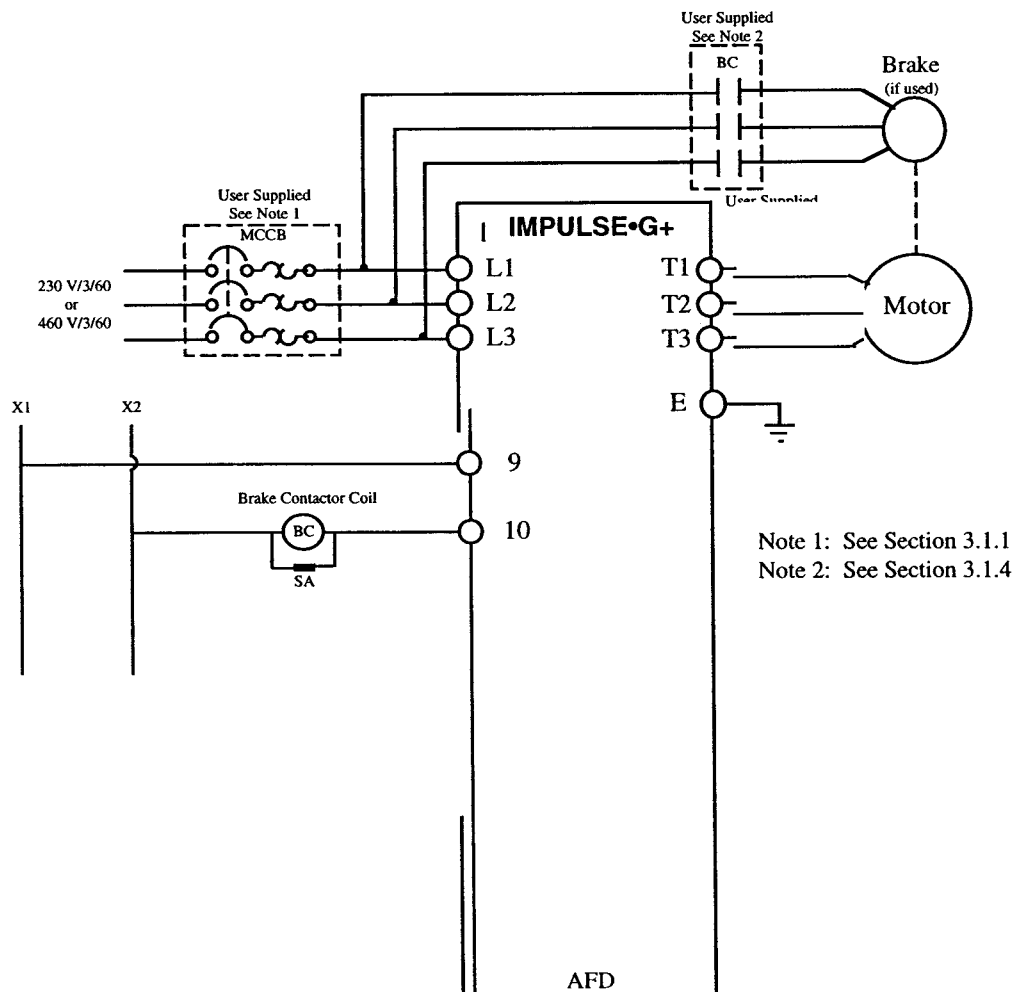

3.1.1. Input Fuse or Circuit Breaker Selection and Power Circuit Wire Size

You should have some disconnecting means and branch circuit protection between the incoming three-phase power supply and the **IMPULSE•G+**. This branch circuit protection can either be in the form of a thermal magnetic, Molded Case Circuit Breaker (MCCB) or dual element "slow blow" type fuses. Table I shows the recommended MCCB or fuse and power wire size for each of the **IMPULSE•G+** horsepower ratings.

TABLE I
MCCB, Fuse and Power Wire Selection

MODEL NO.	230 AFD ___-G+												
	1-S+	2	3	5	7.5	10	15	20	25	30			
Rated Output Current (A)	4.8	6.4	9.6	16	24	32	48	64	80	96			
Molded Case * Circuit Breaker (MCCB) Rating (A)	10	10	15	25	30	40	60	80	100	125			
**Input Fuse #	8	10	15	25	30	40	60	80	100	125			
Power Circuit Wiring (L1, L2, L3 & T1, T2, T3)	12 AWG	12 AWG	12 AWG	12 AWG	12 AWG	10 AWG	8 AWG	6 AWG	4 AWG	2 AWG			
MODEL NO.	460 AFD ___-G+												
	1	2	3	5	7.5	10	15	20	25	30	40	50	60
Rated Output Current (A)	2.6	4.0	4.8	8.0	12	16	24	32	40	48	64	80	96
* Molded Case Circuit Breaker (MCCB) Rating (A)	10	10	10	15	20	25	30	40	50	60	80	100	125
**Input Fuses #	4	6	8	12	20	25	30	40	50	60	80	100	125
Power Circuit Wiring (L1, L2, L3 & T1, T2, T3)	12 AWG	12 AWG	12 AWG	12 AWG	12 AWG	12 AWG	12 AWG	10 AWG	8 AWG	8 AWG	6 AWG	4 AWG	2 AWG

* G.E. Type T.E.D or Equivalent

** Use rejection type fuses, class J or class CC, with time delay
Bussman--FNQR, JHC & LPJ; Gould--AJT & ATMR; Littelfuse--KLKR

3.1.2 Grounding

Connect a positive ground using terminal "E" on the drive chassis

- * Wire size should be at least # 14 AWG. The lead length should be kept as short as possible.
- * Ground resistance should be 100 ohms or less.
- * Never ground the **IMPULSE•G+** along with welding machines, large current machines, etc.
- * Where several **IMPULSE•G+** units are used together all of them should be directly grounded to a common ground pole. Alternatively, connecting all of the **IMPULSE•G+** Earth (E) ground terminals together and running a single wire to the ground pole is also acceptable. Be careful to ensure that you do not form a loop with the ground wires.

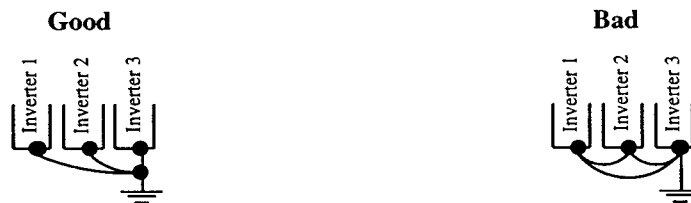

Figure 4: Grounding of Multiple **IMPULSE•G+** Units

3.1.3 Motor Thermal Overload Protection

To prevent the motor from overheating, **IMPULSE•G+** can be programmed to provide motor overload protection. For a complete description of this standard feature, see Section 8.4.

Note 1: When multiple motors are being operated in parallel using a single **IMPULSE•G+**, separate thermal overload relays may be used to provide motor overload protection for each motor. In this case, programmable, electronic motor overload protection may be disabled.

Note 2: A thermal overload relay is not required when the motor(s) has thermal detector(s) embedded in its windings. Because operating fan-cooled motors at low speeds may overheat the motor (even at rated current), the use of thermal detectors in the motor is recommended when using **IMPULSE•G+** with fan-cooled motors. Although this is not the case with non-ventilated type motors, thermal detectors will always provide a level of protection not available with conventional thermal overload relays. It is recommended that programmable overload protection be enabled and utilized even when motor thermal detectors are provided.

3.1.4 Motor Brake Magnetic Contactor

IMPULSE•G+ generates a variable voltage output (dependent on output frequency). For this reason, a magnetic contactor (BC) must be installed to provide the motor brake with line power (See Figure 3). NOTE: When using a motor brake in conjunction with **IMPULSE•G+**, the brake power supply must be from the commercial power supply-- not derived from the **IMPULSE•G+** output terminals.

- * Figure 3 shows a typical wiring scheme for use with a 3 phase motor brake. If a single phase brake is used, use two poles of the 3-pole motor brake magnetic contactor.
- * **A suitable surge absorber must be wired across the brake contactor coil(s) to prevent excessive voltage transients when the coil(s) is de-energized.** For AC coil brakes you should use an R-C type (not MOV type) suppressor. For DC coil brakes you should use a diode type suppressor.

3.1.5 Mainline Magnetic Contactor

Caution: NEVER connect a magnetic contactor between the motor and the IMPULSE•G+ output terminals (T1, T2, T3). Opening of such a contactor while the unit is driving a motor will result in a large transient voltage that could result in power device failure. Closing of such a contactor after the unit is running will result in a large locked rotor, in-rush current that could eventually weaken the power devices.

If a mainline, input magnetic contactor is used it should be wired to provide line power to the input terminals of the **IMPULSE•G+** (or multiple units in separate branch circuits) when the contactor coil is energized via a typical momentary/maintained on/off control circuit.

3.1.6 Special Warnings for Power Semi-Conductors

- * **Never wire the incoming AC power (230 Volt or 460 Volt) to the output terminals (T1, T2, T3). Applying this voltage to the IMPULSE•G+ output will destroy the unit.**
- * Never connect power factor correction capacitors across the output terminals (T1, T2, T3) of the unit.
- * Ensure there are no short circuits on the **IMPULSE•G+** output terminals.
- * Never megger the motor leads while the **IMPULSE•G+** is connected. The power semi-conductors are vulnerable to such high, transient voltages.

3.2 Control Circuit Interconnections

Figure 5

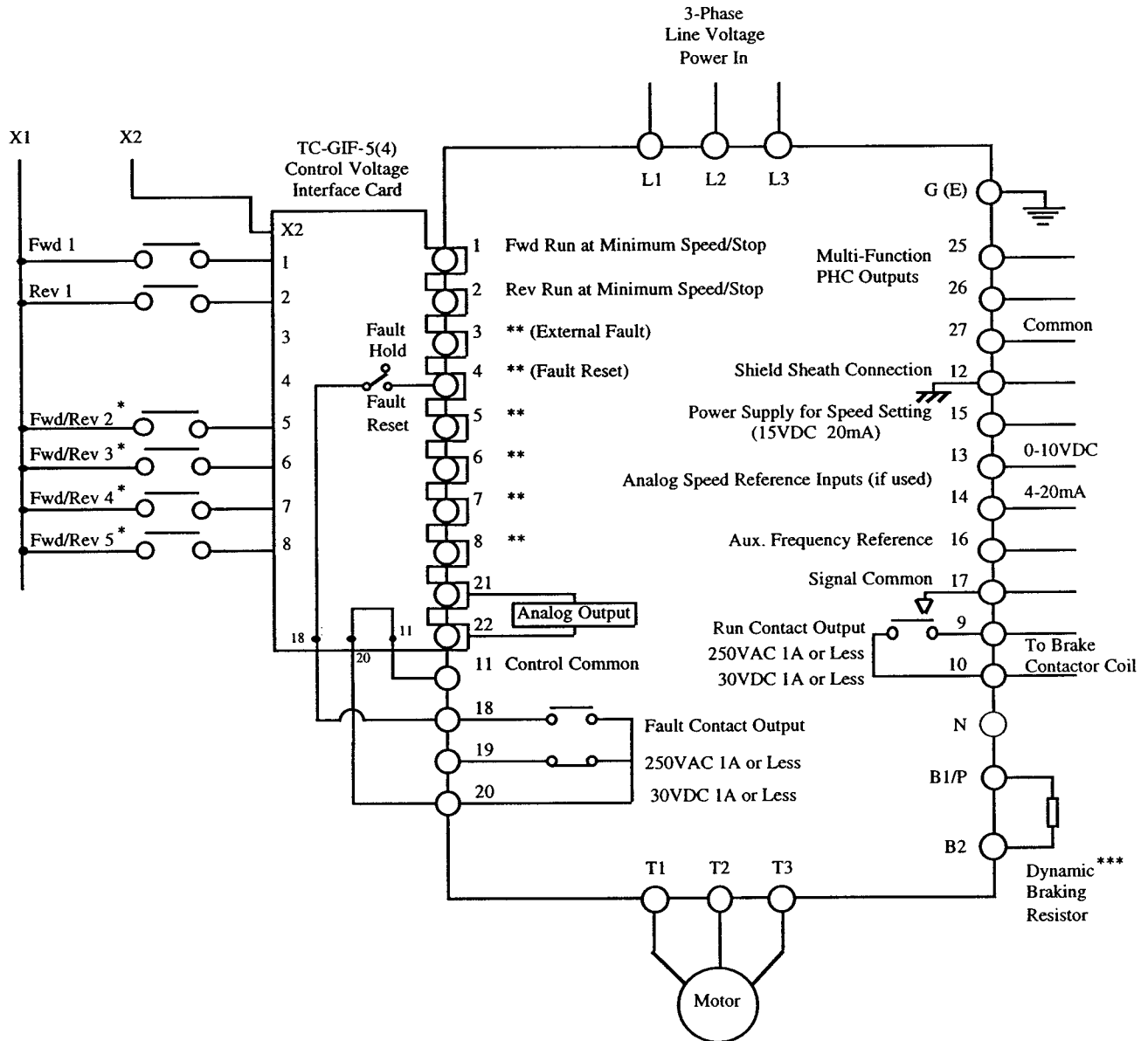

* Number of input conductors is dependent on chosen speed control method.

** Programmable multi-function inputs. Selections include run at 2nd speed, run at 3rd speed, run at 4th speed, run at 5th speed hold speed, increase speed, select alternate accel time, select alternate decel time, external fault, external reset.

*** Connections shown are for applications not requiring external dynamic braking transistor. External braking transistor(s) may be required on 230V, 15-30 hp and 460V, 25-60 hp.

3.2.1 Wire Size

All of the control wiring used with the **IMPULSE•G +** unit should be at least 16 AWG.

3.2.2 Direction and Speed Selection Input Commands

The **IMPULSE•G+** has been specifically designed to be directly compatible with 120 VAC input signals. There is no need to add interface relays or isolation circuitry. The **IMPULSE•G+** control inputs are all optically isolated to provide superior immunity from electrical noise, which is so common in the industrial environment.

The control inputs for crane, hoist, and monorail applications are typically provided by means of a remote operator's station or pendant control (i.e. pushbutton station). Figure 5 (shown on the previous page) shows a common control scheme utilizing a "cumulative-type", 5-step pushbutton station.

IMPORTANT NOTE: The number of input steps required (1-step, 2-step, 3-step, 4- step, or 5- step) is dependent upon the chosen method of speed control. Section 6 of this manual outlines the various speed control methods that are available with the **IMPULSE•G+** and lists the number of input steps required to achieve that particular method of speed control. Once the speed control method is known, the actual control circuit interconnection requirements are known. In fact, the power and flexibility of the **IMPULSE•G+** allows the user to change from one speed control method to another without changing any input wires, so long as each method utilizes the same number of input steps (See Section 6 for details).

3.2.3 Motor Brake Interlock Output Command

The **IMPULSE•G+** has been specifically designed to provide an output signal that is used to energize the brake contactor coil (BC) and release the motor brake at the same time the unit receives a forward/reverse command (This output is often referred to as a "Run Contact Output" - See figure 5).

IMPORTANT NOTE: The state of the brake interlock output signal when the **IMPULSE•G+** receives a stop command is dependent upon the chosen method of braking. Section 6.2 of this manual outlines the two different methods of braking that are available with the **IMPULSE•G+**. Regardless of the braking method, the control wiring does not change. In fact, the power and flexibility of the **IMPULSE•G+** allows the user to change from one braking method to another without changing any wires. (See Section 6 for more details.)

3.2.4 Motor Thermal Overload

If motor overload protection is being provided by **IMPULSE•G+**, an inverter fault condition (operation is stopped and fault code is displayed on keypad) will occur in the event of a motor overload.

Note 1: If thermal overload relays are being employed, the normally closed relay contacts should be wired in series with the (X2) signal lead.

Note 2: When motors with thermal detectors are used, the normally closed overload contact should be wired in series with the (X2) signal lead.

Note 3: When only a single direction is to be interrupted by a motor overload condition, the overload relay contact should be placed in series with the appropriate directional input. *IMPORTANT NOTE: a motor overload condition detected by **IMPULSE•G+** will always interrupt operation in both directions.*

3.2.5 Fault Relay Output Contacts

A fault relay Form C contact (Normally open/Normally closed) output is provided on the 1 PCB main circuit board (Terminals 18, 19, 20). This can be used in a specific control scheme to signal an **IMPULSE•G+** protective fault condition (See Figure 5).

This output is normally utilized with the TC-GIF-5(4) interface circuit to perform fault hold/ fault reset function. See section 12.2 for more details.

3.2.6 Additional Wiring Precautions

An R-C type (not MOV type) surge absorber MUST BE used across the coil of all contactors and relays contained within the same electrical enclosure as the **IMPULSE•G+.** Failure to do so will result in noise related nuisance fault conditions (see Table 2 for applicable surge absorbers).

R-C type (not MOV type) surge absorbers are sometimes required to suppress the coils of AC electro-mechanical brakes. Especially be certain to test all functions of the **IMPULSE•G+** system if 3Ø AC brakes are applied (see Table 2 for applicable surge absorbers). Failure to adhere to this precaution may lead to nuisance noise related fault conditions.

Source KVA MUST BE limited to ≤ 500 KVA to protect against premature rectifier assembly failure. If Source KVA exceeds 500KVA, then installation of appropriate reactor is required. If multiple inverters are used, installation of individual reactors is not required--one reactor capable of combined amperage is acceptable (see Table 3 for details).

3.2.6 Additional Wiring Precautions (Con't)

Table 2: R-C Surge Absorber Specifications

Applied VAC/ General Application	Capacitor	Resistor	Part Number*
120VAC(1Ø) For Contactor Coil/ Magnetic Brake Coils	0.47µFd	100	RCS1C6
	0.47µFd	150	RCS1H6
	0.47µFd	220	RCS1A6
240VAC(1Ø) For Contactor Coil/ Magnetic Brake Coils	0.47µFd	100	RCS2G6
	0.47µFd	150	RCS2H6
	0.47µFd	220	RCS2A6
480VAC (3Ø) For 3Ø Brake Coils	0.47µFd	100	RCY6G-30
	0.47µFd	220	RCY6A-30

 = EMS Standard (if A-B brand contactor (IEC type) is used then p/n is A-B 199-FSMA1)

*Note: Part numbers are those of R-K Electronics. These parts are available either from Electromotive Systems, Inc. or R-K. R-K Phone: 513-489-4060.

Table 3: AC Reactor Specifications*

IMPULSE•G+ Model No.	230V Part No.	460V Part No.
<input type="checkbox"/> AFD1-G+	REA230-1	REA460-1
<input type="checkbox"/> AFD2-G+	REA230-2	REA460-2
<input type="checkbox"/> AFD3-G+	REA230-3	REA460-3
<input type="checkbox"/> AFD5-G+	REA230-5	REA460-5
<input type="checkbox"/> AFD7.5-G+	REA230-7.5	REA460-7.5
<input type="checkbox"/> AFD10-G+	REA230-10	REA460-10
<input type="checkbox"/> AFD15-G+	REA230-15	REA460-15
<input type="checkbox"/> AFD20-G+	REA230-20	REA460-20
<input type="checkbox"/> AFD25-G+	REA230-25	REA460-25
<input type="checkbox"/> AFD30-G+	REA230-30	REA460-30
<input type="checkbox"/> AFD40-G+		REA460-40
<input type="checkbox"/> AFD50-G+		REA460-50
<input type="checkbox"/> AFD60-G+		REA460-60

*Note: Reactors are 3% Impedance Type - Part numbers are for reactors provided by Electromotive Systems, Inc.

Customer Notes:

SECTION 4: DIGITAL OPERATOR

4.1 Operator Layout & Key Functions:

The **IMPULSE•G+** is a completely digital controller that can be used to precisely control the motions of a standard three-phase induction motor to facilitate variable speed control. Being completely digital, there are no potentiometers or selector switches to be tampered with. Instead, the unit is shipped with a digital keypad as standard. This device is very powerful, not only allowing convenient access to the programming parameters, but it also provides alpha-numeric indication of fault codes to simplify troubleshooting. This digital keypad will allow you to do the following:

- * Program the various parameters (or constants)
- * Read alpha-numeric fault diagnostics
- * Monitor the performance of the unit

This digital keypad is shown below:

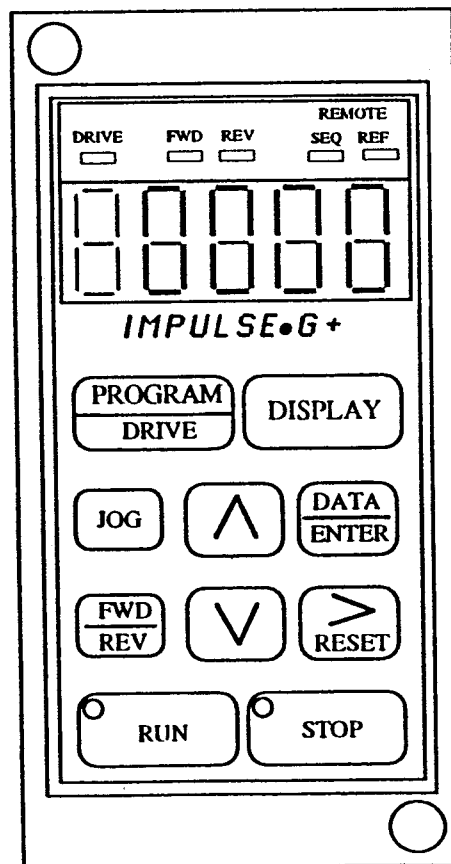

Customer Notes:

4.2 Programming Mode Key Functions

Some keys on the digital keypad have dual purposes, depending on whether the keypad is being used to program various parameters (or constants) or to operate the unit locally.

The various keypad functions are listed below whenever the **IMPULSE•G+** is being used to program various parameters (or is in the program mode):

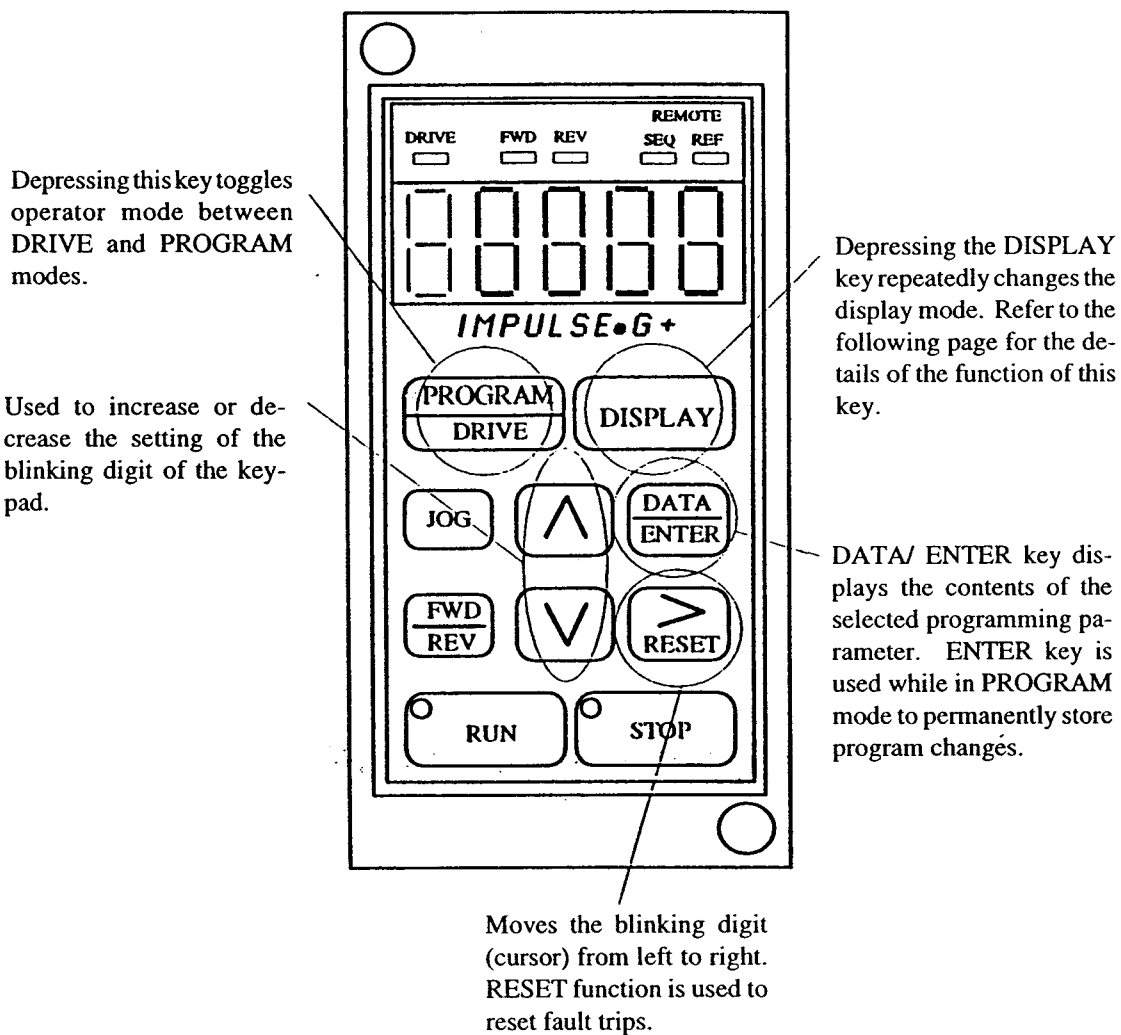

4.2 Programming Mode Key Functions (Continued)

Each time the **DISPLAY** key is pressed the display mode will be varied according to the diagram given below.

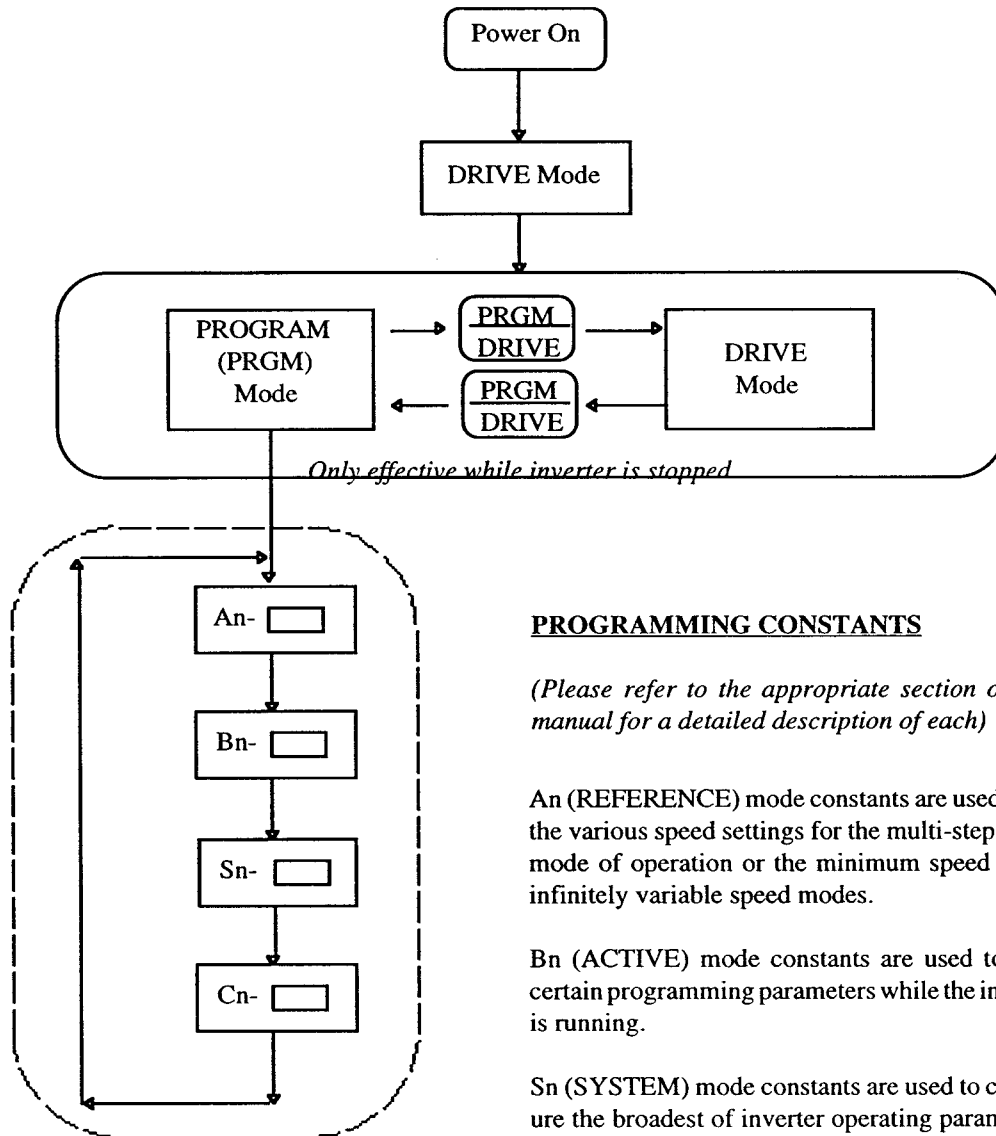

PROGRAMMING CONSTANTS

(Please refer to the appropriate section of this manual for a detailed description of each)

An (REFERENCE) mode constants are used to set the various speed settings for the multi-step speed mode of operation or the minimum speed in the infinitely variable speed modes.

Bn (ACTIVE) mode constants are used to vary certain programming parameters while the inverter is running.

Sn (SYSTEM) mode constants are used to configure the broadest of inverter operating parameters. Typical functions would be speed setting mode, V/F pattern, etc.

Cn (CONTROL) mode constants are used to fine tune the inverter operating characteristics.

4.3 Local Operator Control Mode Key Functions

(note: in most cases, local operation is ONLY used for troubleshooting purposes)

The various keypad functions are listed below whenever the **IMPULSE•G+** is in the DRIVE Mode (or ready to run the motor, either locally or remotely via external input commands).

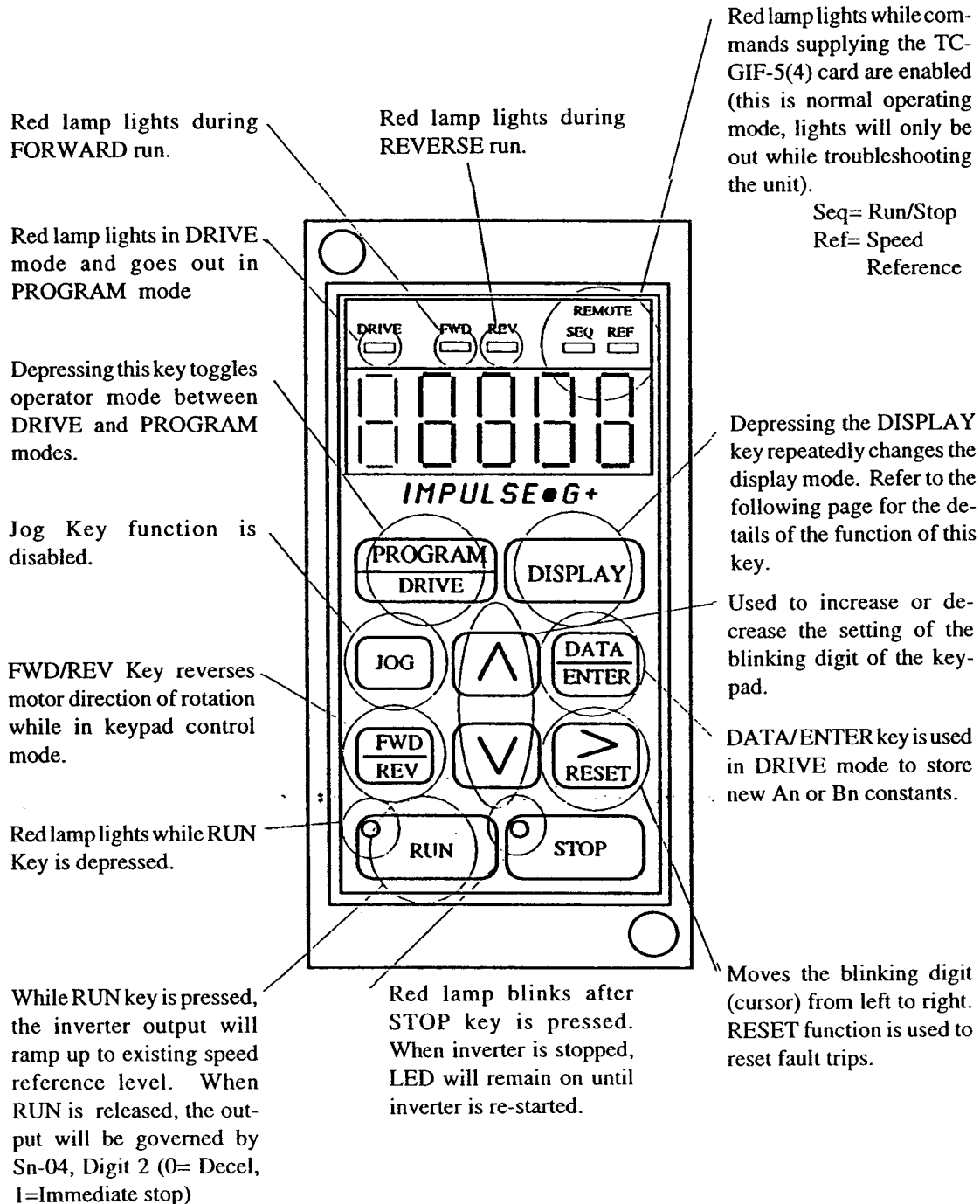

4.3 Local Operator Control Mode Key Functions (Continued)

Each time the **DISPLAY** key is pressed the display mode will be varied according to the diagram given below.

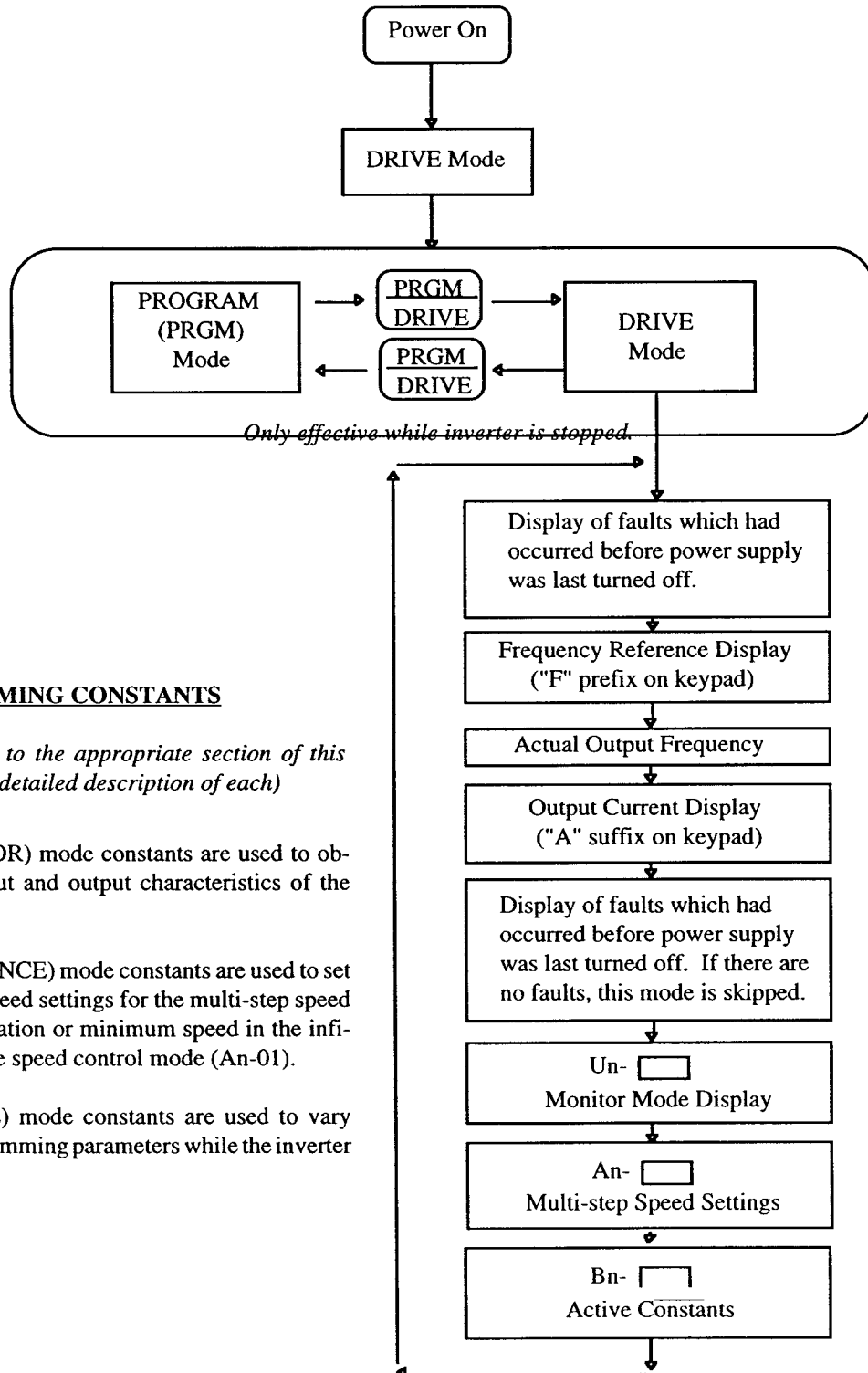

PROGRAMMING CONSTANTS

(Please refer to the appropriate section of this manual for a detailed description of each)

Un (MONITOR) mode constants are used to observe the input and output characteristics of the inverter.

An (REFERENCE) mode constants are used to set the various speed settings for the multi-step speed mode of operation or minimum speed in the infinitely variable speed control mode (An-01).

Bn (ACTIVE) mode constants are used to vary certain programming parameters while the inverter is running.

SECTION 5: TO BEGIN PROGRAMMING

5.1 What is a "CONSTANT" ?

* In this manual, the term "Constant" simply refers to one of many operating parameters which can be adjusted and/or monitored. These constants are organized according to function and grouped into several constant "modes". Each mode carries a two letter code as a designator (either An, Bn, Cn, Sn, or Un). Therefore, regardless of the existing display, it is very easy to navigate your way through the various programming constants by depressing the Display key at any time, (please refer to Section 4.2 & 4.3 for details of the interrelationships between the constant modes).

- * There are four programming constant modes available and these are:
 - Multi-step speed REFERENCE mode (An) Constants
 - ACTIVE mode (Bn) Constants which can be "tuned" while the inverter is operating.
 - SYSTEM mode (Sn) Constants are available to set the inverter's broadest operating characteristics (i.e. input/ output characteristics, V/F pattern)
 - CONTROL mode (Cn) Constants are used to fine tune the inverter operation.

* In addition, there is one group of constants used specifically to monitor the input and output characteristics of the inverter. These are called the MONITOR mode (Un) Constants. These functions essentially eliminate the need for external test equipment or meters at the time of start-up. If a fault trip occurs, these constants can also be very useful in the troubleshooting process. See Section 5.2.5.

5.2 Access to various Constant modes

* There are two levels of accessibility to the programming constant modes. As you might expect, these two options are controlled by yet another constant. This important constant is called Sn-03 and is located within the SYSTEM mode grouping.

* The table given below details the function of Sn-03

Sn- 03 Data	DRIVE Mode		PROGRAM Mode		Remarks
	Changeable	Not Changeable	Changeable	Not Changeable	
0000	An, Bn	Sn, Cn	An, Bn, Sn, Cn	...	-
0101	An, Bn	Sn, Cn	An, Bn	Sn, Cn	Suggested after start-up is completed

5.2.1 Multi-step speed REFERENCE constants (An constants)

Following is a table illustrating the relationships between the An constant mode and the available, preset speeds.

Please refer to Section 6.1 for a detailed description of each possible speed control mode.

No.	Name	Increment	Setting Range	Initial Value
* An-01	Speed #1	0.01 Hz	1.50 ~ 150.00 Hz	6.00
An-02	Speed #2	0.01 Hz	1.50 ~ 150.00 Hz	15.00
An-03	Speed #3	1 Hz	2 ~ 150 Hz	30
An-04	Speed #4	1 Hz	2 ~ 150 Hz	45
An-05	Speed #5	1 Hz	2 ~ 150 Hz	60
An-06	Speed #6	1 Hz	2 ~ 150 Hz	2

* Note: An-01 is also used to set minimum speed in the infinitely variable speed control modes (both 2 step and 3 step types).

5.2.2 ACTIVE Mode (Bn) Constants

These constants are used for tuning the operating characteristics of the inverter. The primary difference between these and the CONTROL constants (Cn) is that these parameters can be changed even while the inverter is running. All of the other constants in the inverter demand that the inverter is stopped before you can access or change them.

No.	Name	Increment	Setting Range	Initial Value
Bn-01	Acceleration Time 1	0.1S	0.5 ~ 6000.0S	5.0S
Bn-02	Deceleration Time 1	0.1S	0.5 ~ 0025.0S	3.0S
Bn-03	Alternate Acceleration Time	0.1S	0.5 ~ 6000.0S	5.0S
Bn-04	Alternate Deceleration Time	0.1S	0.5 ~ 0010.0S	3.0S
Bn-05	Auto Decel Time	0.1S	0.5 ~ 0025.0S	5.0S
Bn-06	Frequency Reference Gain	1 %	-	100%
Bn-07	Frequency Reference Bias	1 %	-	0%
Bn-08	Torque Compensation Gain	0.1	0.0 ~ 3.0	1.0
Bn-09	Motor Rated Slip	0.1%	0.0 ~ 9.9	0.0
* Bn-10	Display at Power Up	-	1~3	2
Bn-11	Analog Monitor Ch #1 Gain	0.01	-	1.00
Bn-12	Analog Monitor Ch #2 Gain	0.01	-	0.50

- * This function is used to determine the display mode the **IMPULSE•G+** powers up in.
- 1= Frequency speed reference command for local operation (example: F060.0 for 60 hz local operation.)
 - 2= Actual output frequency (Hz)
 - 3= Actual output current (Amps)

5.2.3 Sn-01 Data Table

Sn-01 Set Value	HP Rating (CT)	Model No.
230 Volts		
01	1	230AFD1-G+
02	2	230AFD2-G+
03	3	230AFD3-G+
04	5	230AFD5-G+
05	7.5	230AFD7.5-G+
06	10	230AFD10-G+
07	15	230AFD15-G+
08	20	230AFD20-G+
09	25	230AFD25-G+
0A	30	230AFD30-G+
0b	40	Not Available
460 Volts		
21	1	460AFD1-G+
22	2	460AFD2-G+
23	3	460AFD3-G+
24	5	460AFD5-G+
25	7.5	460AFD7.5-G+
26	10	460AFD10-G+
27	15	460AFD15-G+
28	20	460AFD20-G+
29	25	460AFD25-G+
2A	30	460AFD30-G+
2b	40	460AFD40-G+
2C	50	460AFD50-G+
2d	60	460AFD60-G+

5.2.4 SYSTEM Mode Constants

No.	Name	Digit No	Data	Function	Factory Value
Sn-01	kVA Selection			Inverter Capacity is Selected	*
Sn-02	V/F Selection			V/F Pattern is Selected	01
Sn-03	Operator Status		0000	An, Bn, Cn, Sn Reading and Changing	0101
			0101	Auto-Lockout, cannot change Sn or Cn	
Sn-04	Operation Mode Selection No. 1	1	0	Freq. Ref. & Run/Stop from External Terms.	0010 1 st Digit 4 th Digit
			1	Master Freq. Ref. from Digital Monitor	
		2	0	Decel at Stop Command (time is Bn-02)	
			1	Immediate Stop at Stop Command	
		4, 3	00	S-Curve Enabled	
			01	S-Curve Disabled	
			10	S-Curve Function is 0.5 Second	
		11	S-Curve Function is 1.0 Second		
Sn-05	Operation Mode Selection No.2	1	0	Stop Key on operator always effective	0000 1 st Digit 4 th Digit
			1	Stop Key on operator only effective in local	
		2	0	Scan of Input 2 Times (Digital Filter)	
			1	Scan of Input 1 Time	
		3	0	Analog Out (21-22) Proportional to F-Out	
			1	Analog Out (21-22) Proportional to I-Out	
		4	0	Disable Load Check	
			1	Enable Load Check	
Sn-06	Overtorque Detection	1	0	Overtorque Detection is Disabled	1000 1 st Digit 4 th Digit
			1	Overtorque Detection is Enabled	
		2	0	Overtorque Only Detected at Speed	
			1	Overtorque Always Detected **	
		3	0	OL3 Blinks on Keypad	
			1	OL3 Blinks and Inverter Fault Trips	
		4	-	Not Used	
Sn-07	Stall Prevention Functions Select	1	0	Stall Prevention During Accel is Enabled	0010 1 st Digit 4 th Digit
			1	Stall Prevention During Accel is Disabled	
		2	0	Stall Prevention During Decel is Enabled	
			1	Stall Prevention During Decel is Disabled	
		3	0	Stall Prevention at Set Speed is Enabled	
			1	Stall Prevention at Set Speed is Disabled	
		4	0	Decel Time During Stall at Set Speed= Bn-02	
			1	Decel Time During Stall at Set Speed= Bn-04	

* Initial value depends upon inverter current rating

** Sn-15 thru Sn-17 should be data OB when Sn-06 is data 0010

5.2.4 SYSTEM Mode Constants (Continued)

No.	Name	Digit No.	Data	Function	Factory Value
Sn-08	Protective Characteristics	1	0	Electronic Motor Thermal Prot. - Enabled	0000 1st Digit 4th Digit
			1	Electronic Motor Thermal Prot. - Disabled	
		2	0	Motor Protection for standard motor	
			1	Motor Protection for blower cooled motor	
		3	0	Built-in Braking Resistor NOT Provided	
			1	Built-in Braking Resistor Provided	
		4	0	Disable Swift Lift	
			1	Enable Swift Lift	
Sn-09	Special Functions	2,1	00	Slip Compensation is Disabled	0000 1st Digit 4th Digit
			01	Slip Compensation is Enabled	
			10	Slip Compensation in FWD only	
			11	FWD is + Slip Comp., REV is - Slip Comp.	
		4,3	00	Auto Alt. Accel/Decel Time Changeover at Cn-04	
			01	Auto Decel Time Changeover at Cn-14(F)/Cn-15(R)	
			10	Quick Stop™ Enabled	
Sn-10	Speed Control Method Select		00	5 Step Speed- with cumulative PB	00
			01	4 Step Speed- Two contact control	
			02	8 Step Speed- Three contact control	
			03	3 Step Infinitely Variable	
			04	2 Step Infinitely Variable	
Sn-11	Term. 3 Function			External Fault Function is Factory Value	14
Sn-12	Term. 4 Function			Fault Reset is Factory Value	00
Sn-13	Term. 7 Function			Default is Not Used	0F
Sn-14	Term. 8 Function			Default is Not Used	0F
Sn-15	Contact Output			External Terminal Function (#9- #10, 1PCB)	00
Sn-16	Open Coll. Out #1			Open Collector Function (#25- #27, 1 PCB)	01
Sn-17	Open Coll. Out #2			Open Collector Function (#26- #27, 1 PCB)	02
Sn-18	A0-08, AO-12	2,1	00	Ch #1= Output Frequency (10 V/ 100 %)	0000 1st Digit 4th Digit
			01	Ch #1= Output Current (10 V/ Inv. Rated, A)	
			10	Ch #1= Output Voltage (10 V/ Rated Input)	
			11	Ch #1= DC Bus Voltage *1	
		4,3	00	Ch #2= Output Frequency (10 V/ 100 %)	
			01	Ch #2= Output Current (10 V/ Inv. Rated, A)	
			10	Ch #2= Output Voltage (10 V/ Rated Input)	
		11	Ch #2= DC Bus Voltage *1		
Sn-19	Pulse Monitor			Output Freq. = 6 x Inverter Output Freq.	0010

*1 400 V/ 100 % for 200- 230 VAC units or 800 V/ 100 % for 380- 460 VAC units

5.2.5 CONTROL (Cn) Constants

No.	Name	Unit	Setting Range	Initial Value
Cn-01	Input Voltage (Vin)	0.1 V	150.0 ~ 255.0 *1	230.0 *1
Cn-02	Maximum Frequency (F max)	0.1 Hz	50.0 ~ 150.0	*3
Cn-03	Maximum Voltage (V max)	0.1 V	7.0 ~ 255.0 *1	*3
Cn-04	Freq. of Maximum Voltage (Va)	0.1 Hz	1.5 ~ 150.0	*3
Cn-05	Mid-Point Output Frequency (Fb)	0.1 Hz	1.5 ~ 150.0	*3
Cn-06	Mid-Point Output Voltage (Vc)	0.1 V	7.0 ~ 255.0 *1	*3
Cn-07	Minimum Output Frequency (F min)	0.1 Hz	1.5 ~ 150.0	*3
Cn-08	Minimum Output Voltage (V min)	0.1 V	7.0 ~ 255.0 *1	*3
Cn-09	Max. Volt Freq. for REVERSE	0.1 Hz	1.5 ~ 150.0	*3
Cn-10	V/f Constant (Fb) for REVERSE	0.1 Hz	1.5 ~ 150.0	*3
Cn-11	V/f Constants (Vc) for REVERSE	0.1 V	7.0 ~ 255.0 *1	*3
Cn-12	F min for REVERSE	0.1 Hz	1.5 ~ 150.0	*3
Cn-13	V min for REVERSE	0.1 V	7.0 ~ 255.0 *1	*3
Cn-14	Accel/ Decel time change freq.- FWD.	0.1 Hz	1.5 ~ 150.0	1.5
Cn-15	Accel/ Decel time change freq.- REV.	0.1 Hz	1.5 ~ 150.0	1.5
Cn-16	Motor Rated Current	0.1 A	*2	*4
Cn-17	DC Injection Braking Current	1 %	0 ~ 100	50
Cn-18	DC Injection Time at Stop	0.1 S	0.0 ~ 25.5	0.5
Cn-19	Frequency Reference Upper Limit	1 %	0 ~ 109	100
Cn-20	Frequency Reference Lower Limit	1 %	0 ~ 109	0
Cn-21	Operator Display Scaling @ F max.	--	0 ~ 39999	0
Cn-22	Optional Speed Agree Frequency	0.1 Hz	1.5 ~ 150.0	1.5
Cn-23	BB Time for Direction Change	0.1 S	0.0 ~ 2.6	0.0 *5 †
Cn-24	Overtorque Detection Level	1 %	30 ~ 200	160
Cn-25	Overtorque Detection Time	0.1 S	0.0 ~ 25.5	0.1
Cn-26	F ref 1 for Load Check Function	1Hz	2 ~ 150	60
Cn-27	I ref 1 for Load Check Function	1 %	30 ~ 200	160
Cn-28	F ref 2 for Load Check Function	1Hz	2 ~ 150	60
Cn-29	I ref 2 for Load Check Function	1%	30 ~ 200	160
Cn-30	F ref 3 for Load Check Function	1Hz	2 ~ 150	60
Cn-31	I ref 3 for Load Check Function	1 %	30 ~ 200	160
Cn-32	Detection Time for Load Check	0.1 S	0.1 ~ 2.6	0.1

† (Initial value change to 0.0 on 101362-1)

5.2.5 CONTROL (Cn) Constants (Continued)

No.	Name	Unit	Setting Range	Initial Value
Cn-33	Hold Time for Load Check Function	0.1 S	0.1 ~ 2.5	0.2
Cn-34	Stall Prevention on Accel- Con. Tor.	1 %	30 ~ 200	170
Cn-35	Stall Prevention on Accel- Con. HP	1 %	30 ~ 200	50
Cn-36	Stall Prevention at Set Speed	1 %	30 ~ 200	160
Cn-37	Motor Wire Resistance (ohms)	0.001	0 ~ 65.535	*8
Cn-38	Motor Iron Loss	1 W	0.0 ~ 65535	*8
Cn-39	Torque Comp. Voltage Limit	1 V	0 ~ 50 *6	*8
Cn-40	Motor No Load Current	1 %	0 ~ 99 *7	30
Cn-41	Slip Compensation Delay Time	0.1 S	0.0 ~ 25.5	0.0
Cn-42	Carrier Frequency Upper Limit	0.1 kHz	0.4 ~ 15.0	15.0
Cn-43	Carrier Frequency Lower Limit	0.1 kHz	0.4 ~ 15.0	15.0
Cn-44	Carrier Frequency Gain	1	0 ~ 99	0
Cn-45	SWIFT LIFT Current at Fwd	1%	30 ~ 200% *9	160
Cn-46	SWIFT LIFT Current at Rev	1%	30 ~ 200% *9	160
Cn-47	SWIFT LIFT Frequency	1 Hz	2 ~ 150	60
Cn-48	SWIFT LIFT Acc/ Dec Time Gain	0.1	0.1 ~ 9.9	1.0
Cn-49	SWIFT LIFT Threshold Frequency	1Hz	2 ~ 150	60
Cn-50	SWIFT LIFT Delay Time	0.1 S	0.1 ~ 25.5	2.0
Cn-51	Phase Loss Frequency Set Level	1%	2 ~ 109	5
Cn-52	Phase Loss Current Detect Level	1%	0 ~ 200	5
Cn-53	Phase Loss Detection Delay Time	.1 S	0.0 ~ 2.0	.1

- *1: Setting/ range is doubled for 460 Volt class units (380- 480 VAC)
- *2: Setting range is 10 to 200 % Inverter Rated Current (in Amperes)
- *3: Determined by setting of Sn-02 (V/F Pattern)
- *4: Setting is determined by setting of Sn-01 (KVA Selection)
- *5: For hoisting applications, see Section 9.3.
- *6: Setting/ range is doubled for 400 Volt class units (380- 480 VAC)
- *7: 100 % equals motor rated current programmed into Cn-16
- *8: Setting is determined by setting of Sn-01 (KVA Selection)
- *9: Setting is % of Inverter Rated Current

5.2.6 MONITOR Mode (Un) Constants













The MONITOR Mode (Un) Constants are extremely useful throughout the start-up of the **IMPULSE•G+** unit. These functions actually eliminate the need for meters or sophisticated test equipment at the time of start-up, thus greatly simplifying the job. In addition, these parameters could also prove useful in troubleshooting the unit for improper operation.

No.	Name	Description
Un-01	F-Ref	The Inverter's Commanded Frequency
Un-02	F-Out	The Actual Output Frequency of the Inverter
Un-03	I-Out	The Actual Output Current (Amps) of the Inverter
Un-04	V-Out	The Actual Output Voltage of the Inverter
Un-05	V-Bus	The Actual DC Bus Voltage (VDC) of the Inverter
Un-06	Kw-Out	The Actual KW Output of the Inverter
*Un-07	In-Check	Indicates Status (Open/Closed) of Input Terms. 1~8
Un-08	Out-Check	Indicates Status (Open/Closed) of Output Terms. 9-10, 25 & 26
Un-09	LED-Check	Indicates if Digital Monitor LEDs are functioning properly
Un-10	PROM-No.	Indicates Software Number of Inverter EPROM

* Input signal Check function is particularly useful for checking the status of input contact closures from pushbutton pendant station or other controlling device. During troubleshooting using Un-07, the inverter must be in the PROGRAM mode.

5.3 Programming Enable-- Defeating Automatic Keypad Lockout™

Whenever an **IMPULSE•G+** is initially powered up, the programming features of the unit are disabled. This is done to eliminate the possibility of someone inadvertently changing any of the programming constants. If you should need to change any of the available parameters, you will first need to change the data stored in constant Sn-03. The step-by-step procedure is given below:

		display reads An-01
		display reads Bn-01
		display reads Sn-01
		display reads Sn-02
		display reads Sn-03
Initial Setting, Sn-03=0101		display reads 0101, with left-hand digit blinking
To enable the option of modifying the programming parameters, you must set Sn-03=0000.		display reads 0101, blinking digit was moved one location to the right
		display reads 0001, blinking digit has changed from "1" to "0"
		display reads 0001, blinking digit was moved one location to the right
		display reads 0001, blinking digit was moved one location to the right
		display reads 0000, blinking digit was changed from "1" to "0"
		display momentarily reads "END", then returns to 0000

You may now make any necessary program changes to the constants. **Remember, each time you remove the power from the unit, the Auto-lockout feature will again reset Sn-03=0101, prohibiting further changes. This means the procedure listed above must be repeated.**

5.4 Simple Programming

5.4.1 How to Change the Minimum Operating Speed (An-01)

To change the minimum operating speed you need to change the value of constant An-01. Regardless of the speed setting method you have selected (see description in Section 6), constant An-01 will serve as speed setting #1 and minimum speed. Lets do an example in which you want to set the minimum speed to 9 Hz (Note: Initial value from the factory is 10% of 60 Hz, or 6 Hz). As a result, we must change the setting of An-01 from the factory setting of "006.00" to "009.00".



display reads An-01, "Drive" LED on keypad goes out



display reads 0 0 6. 0 0



press until display reads 0 0 6. 0 0



press until display reads 0 0 9. 0 0



display momentarily reads "END", then returns to
0 0 9. 0 0













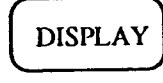

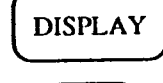
display returns to the display mode before this procedure
had started

5.4 Simple Programming (Continued)

5.4.2 How to Change Any of the Speed Settings (An Constants)

To change the digitally preset operating speeds, you need to change one of the An Constants. The value stored in constant An-01 relates to operating speed #1 (the procedure for changing the others is the same). Let's do an example in which the desired operating speed is 25 % of maximum speed. Maximum speed normally translates to a maximum output frequency of 60 Hz, so we should set An-01= 15.00 Hz. We will assume that our minimum speed is currently set at "003.00".







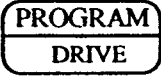

*Existing Frequency Reference Command		display reads F 0 0 . 0 0
Actual Output Frequency		display reads 0 0 . 0 0
Actual Output Current		display reads 0 0 0 . 0 A
Monitor Mode No. 1		display reads U n - 0 1
Speed Setting #1		* display reads A n - 0 1
* The keypad digital display that appears is dependent on the present selected DISPLAY mode.		display reads 0 0 3. 0 0
		display reads 0 0 3. 0 0
		display reads 0 1 3. 0 0
		display reads 0 1 3 . 0 0
		press 5 times, until display reads 0 1 5 . 0 0
		display momentarily reads "END", then returns to 0 1 5 . 0 0
		Press until you return to the desired DISPLAY mode

* Note: if you wish to change one of the other speed settings, simply press the  key until the desired constant appears on the operator

5.4 Simple Programming (Continued)

5.4.3 How to Change Accel Time (Bn-01) (to Change Decel Time, use Bn-02)

To change the accel (or decel) ramp, you must change Bn-01 (Bn-02). Assume the setting is 10.0 seconds. This is defined as the time it takes the output to go from zero speed to maximum speed. As an example, lets assume you would like to increase the accel time from 10.0 secs. to 15.0 secs. Follow the step-by-step procedure listed below:

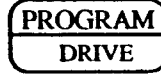
	display reads An-01, "Drive" LED on keypad goes out
	display reads B n - 0 1
	display reads 0 0 1 0 . 0
	display reads 0 0 1 0 . 0
	display reads 0 0 1 0 . 0
	display reads 0 0 1 0 . 0
	press until display reads 0 0 1 5 . 0
	display momentarily reads "END", then returns to 0 0 1 5 . 0
	keypad returns to display mode it was in when you began this procedure.

Customer Notes:

SECTION 6. CONTROL FLEXIBILITY

ELECTROMOTIVE SYSTEMS **IMPULSE•G+** is a unique combination of hardware and software that provides the user with unparalleled sophistication and flexibility for selection of specific crane/hoist operation modes. These include:

- * Speed Control Method Selection
 - Multi-Step Mode
 - 2-Step Infinitely Variable Mode
 - 3-Step Infinitely Variable Mode
- * Stopping Method Selection
 - Immediate Stop at STOP Command
 - Decelerate at STOP Command

6.1 Speed Control Method Definitions (Set by Constant Sn-10)

6.1.1 Multi-Step Speed Control Method (Sn-10 = "00")

IMPULSE•G+ allows the user to choose between Two speed, Three speed, Four speed or Five Speed operation. The number of speeds is dependent upon the number of input signals. Each input signal is assigned a frequency (speed) reference from the "An" Group as described below:

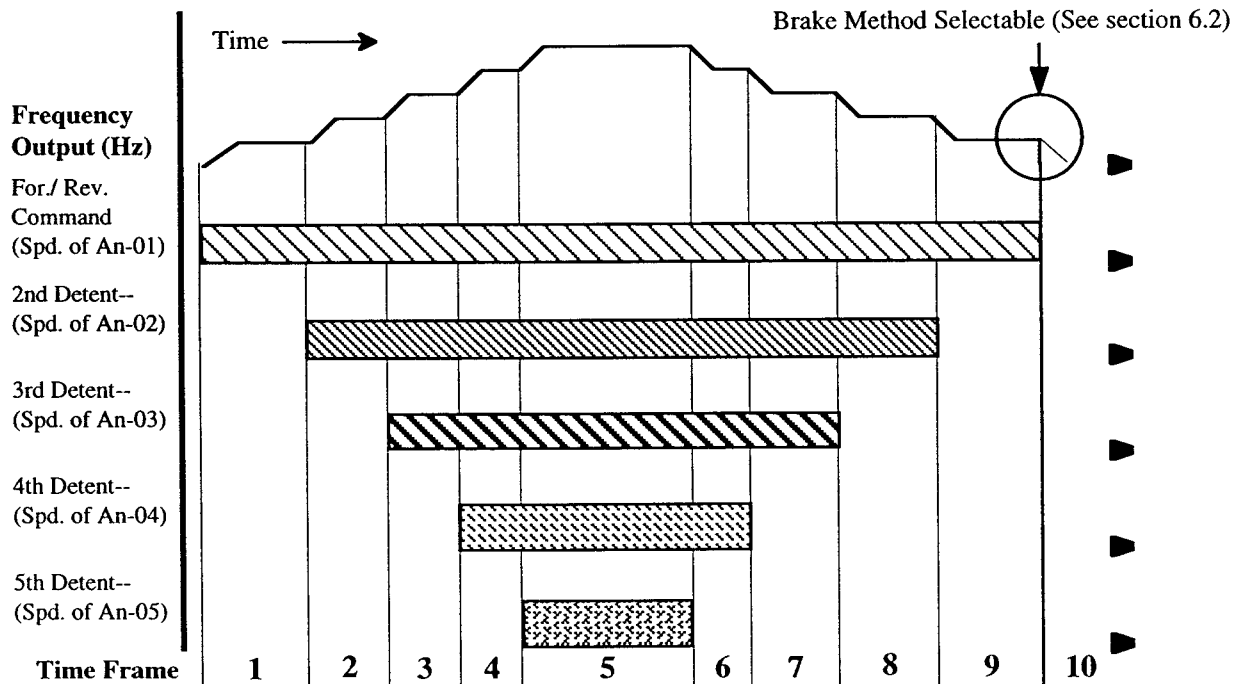

6.1.1 Multi-Step Speed Control Method (Sn-10 = "00") (Cont.)

Time Frame Descriptions

- Time**
- 1 Run Forward/ Reverse Command--Freq. output increases to Hz of constant "An-01". Operation continues at speed of An-01.
 - 2 Second Detent/2nd Speed Command--Freq. output increases to Hz of constant "An-02". Operation continues at speed of An-02.
 - 3 Third Detent/3rd Speed Command--Freq. output increases to Hz of constant "An-03". Operation continues at speed of An-03.
 - 4 Fourth Detent/4th Speed Command--Freq. output increases to Hz of constant "An-04". Operation continues at speed of An-04.
 - 5 Fifth Detent/5th Speed Command--Freq. output increases to Hz of constant "An-05". Operation continues at speed of An-05.
 - 6 Removal of Fifth Detent/5th Speed Command--Freq. output decreases to Hz of "An-04". Operation continues at speed of An-04.
 - 7 Removal of Fourth Detent/4th Speed Command--Freq. output decreases to Hz of "An-03". Operation continues at speed of An-03.
 - 8 Removal of Third Detent/3rd Speed Command--Freq. output decreases to Hz of "An-02". Operation continues at speed of An-02.
 - 9 Removal of Second Detent/2nd Speed Command--Freq. output decreases to Hz of "An-01". Operation continues at speed of An-01.
 - 10 Absence of Commands (Removal of Run Forward/ Reverse)--STOP. Operation depends upon the setting of constant Sn-04, Digit 2*.

*****IMPORTANT FACTS ABOUT "STOPPING Methods"*****
 Factory initial value of Sn-04, Digit 2 is "1"--Immediate Stop. To Change to Deceleration at Stop Command, change Sn-04, Digit 2 to data "0". **Extreme caution should be used** when changing to "deceleration at Stop command". Operation should not begin until the user has reviewed the deceleration time found in constant Bn-02. A long deceleration time will cause driven equipment to require a greater stopping distance.

6.1.1.1 Input Terminal Status/ Output Frequency (Speed) Operation

Terminals Used For 5 Step Control					
Terminals Used For 4 Step Control					Output Freq. (Speed) Ref.
Terminals Used For 3 Step Control				Terminals X2~8	
Terminals Used For 2 Step Control			Terminals X2~7		
Terminals X2~1 (2)	Terminals X2~5	Terminals X2~6			
0	X	X	X	X	***STOP***
1	0	0	0	0	An-01
1	1	0	0	0	An-02
1	1	1	0	0	An-03
1	1	1	1	0	An-04
1	1	1	1	1	An-05

1 = 120VAC between Terms. of TC-GIF-5(4); 0 = 0VAC between Terms. of TC-GIF-5(4); X = Don't Care

6.1.2 Infinitely Variable Speed Control Method (2-Step Type) (Sn-10 = "04")

IMPULSE•G+ provides for true infinitely variable speed control with just two (2) simple 120VAC inputs. This unique software function allows the use of inexpensive two speed pushbuttons. Two (2)-Step infinitely variable is most often used on horizontal travel motions where it is acceptable to decelerate the motor when a STOP command is applied (The control device is returned to the off position). Two (2)-Step Infinitely Variable Speed Control is described by the following timing chart:

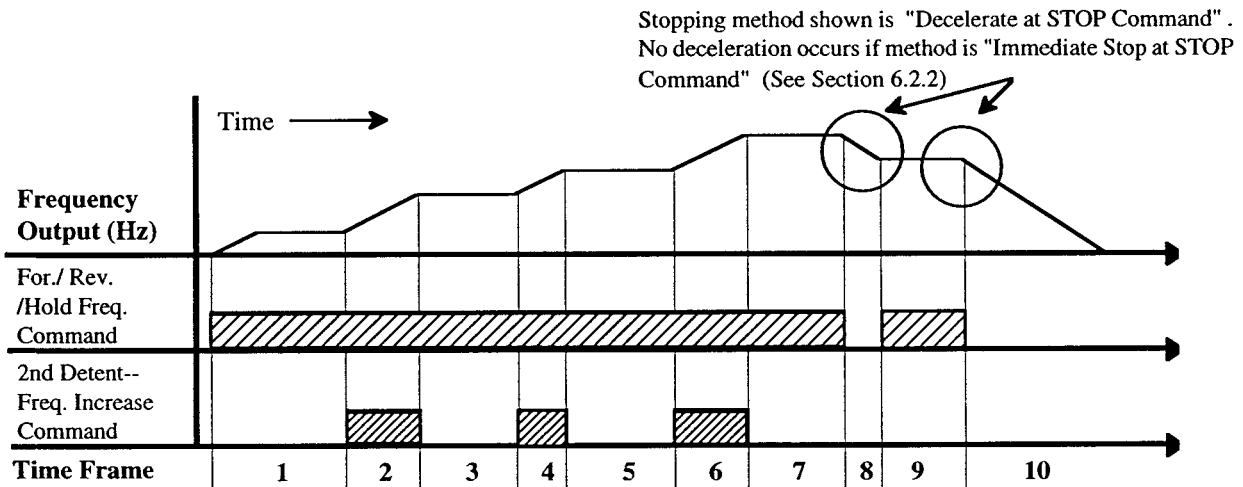

- | | |
|-------------|--|
| Time | <p>1 Run Forward (Reverse) at Freq. of An-01/ Hold Freq. Command. Frequency output increases to frequency of An-01. Operation continues at speed of An-01.</p> <p>2 Second Detent/Freq. Increase Command--Freq. output increases. The longer this contact is closed, the higher the frequency output becomes--limited only by the adjustable upper limit (Cn-19 set value/ F-Max [Cn-02 set value]).</p> <p>3 First Detent/ Freq. Hold Command--Freq. output remains constant.</p> <p>4 Second Detent/ Freq. Increase Command--Freq. output increases. The longer this contact is closed, the higher the frequency output becomes--limited only by the adjustable upper limit (Cn-19 set value/ F-Max (Cn-02 set value).</p> <p>5 First Detent/ Freq. Hold Command--Freq. output remains constant.</p> <p>6 Second Detent/ Freq. Increase Command--Freq. output increases. The longer this contact is closed, the higher the frequency output becomes--limited only by the adjustable upper limit (Cn-19 set value/ F-Max (Cn-02 set value).</p> <p>7 First Detent/ Freq. Hold Command--Freq. output remains constant.</p> <p>8 Absence of Commands = STOP Command. Output frequency decreases. The longer this input signal condition exists, the lower the output frequency becomes. Output frequency will go to Zero, and the brake will set. Braking method shown is "Decelerate at STOP Command" only! (See Section 6.2.2).</p> <p>9 First Detent/ Freq. Hold Command--Freq. output remains constant.</p> <p>10 Absence of Commands = STOP Command. Output frequency decreases. The longer this input signal condition exists, the lower the output frequency becomes. Output frequency will go to Zero, and the brake will set automatically. Stopping method is "Decelerate at STOP Command" only! (See Section 6.2.2).</p> |
|-------------|--|

**6.1.2.1 Input Terminal Status/ Output Frequency (Speed) Operation for
 2-Step Infinitely Variable Speed Control Method**

Terminals X2~1 (2)	Terminals X2~5	Output Freq. (Speed) Ref.
0	X	***STOP***
1	0	An-01/ Frequency Hold Command**
1	1	Frequency is increasing (limited by Cn-19)

1 = 120VAC between Terms. of TC-GIF-5(4); 0 = 0VAC between Terms. of TC-GIF-5(4); X = Don't Care

*****IMPORTANT FACTS ABOUT "STOPPING Methods"*****
 Factory initial value of Sn-04, Digit 2 is "1"--Immediate Stop . To Change to Deceleration at Stop Command, change Sn-04, Digit 2 to data "0". **Extreme caution should be used** when changing to "deceleration at Stop command". Operation should not begin until the user has reviewed the deceleration time found in constant Bn-02. A long deceleration time will cause driven equipment to require a greater stopping distance.

****Note:** Changeover of An-01 Command/ Frequency Hold Command is when F-Out = 0
 1) First operation of terminal 1 (2) after F-Out = 0 commands speed of An-01.
 2) Subsequent operations of terminals 1 (2) commands "Frequency Hold".

6.1.3 Infinitely Variable Speed Control Method (3-Step Type) (Sn-10 = "03")

IMPULSE•G+ provides true infinitely variable speed control with Three (3) simple 120VAC inputs. Three (3)- Step infinitely variable speed control is most often used on hoist motions where it is not acceptable to decelerate the motor when a STOP command is applied (The control device is returned to the off position). Three (3)-Step Infinitely Variable Speed Control is described by the following timing chart.

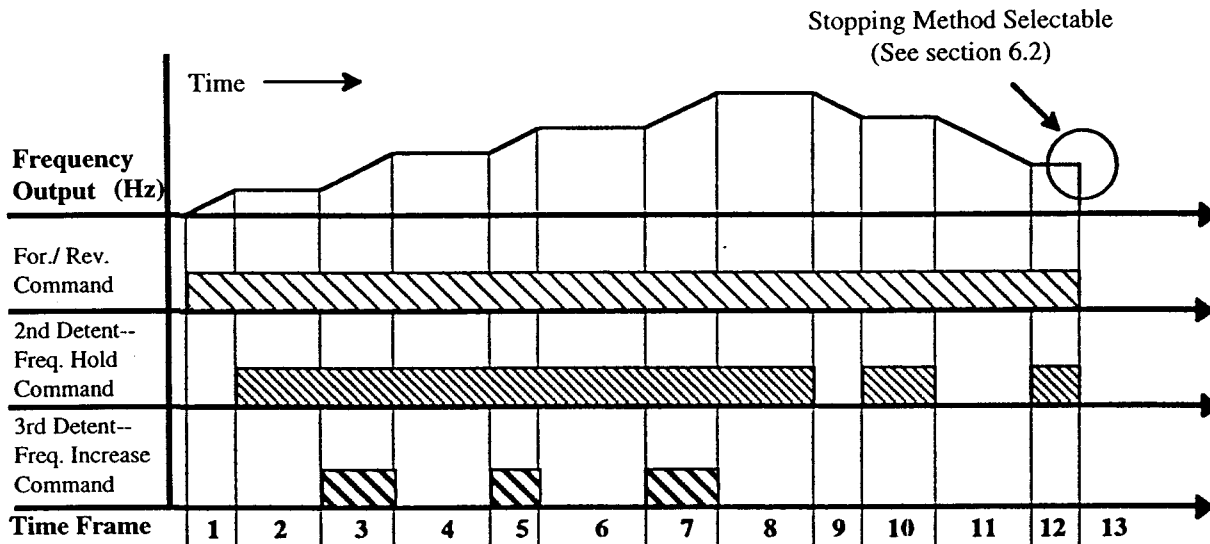

- | | | |
|-------------|----|--|
| Time | 1 | Run Forward/ Reverse Command--Freq. output increases to Hz of constant "An-01". Operation continues at speed of An-01. |
| | 2 | Second Detent/Freq. Hold Command--Freq. output remains constant. |
| | 3 | Third Detent/Freq. Increase Command--Freq. output increases. The longer this contact is closed, the higher the output frequency becomes--limited only by the adjustable upper limit (Cn-19 set value/ F-Max(Cn-02 set value)). |
| | 4 | Second Detent/ Freq. Hold Command--Freq. output remains constant. |
| | 5 | Third Detent/Freq. Increase Command--Freq. output increases. The longer this contact is closed, the higher the output frequency becomes--limited only by the adjustable upper limit (Cn-19 set value/ F-Max(Cn-02 set value)). |
| | 6 | Second Detent/ Freq. Hold Command--Freq. output remains constant. |
| | 7 | Third Detent/Freq. Increase Command--Freq. output increases. The longer this contact is closed, the higher the output frequency becomes--limited only by the adjustable upper limit (Cn-19 set value/ F-Max(Cn-02 set value)). |
| | 8 | Second Detent/ Freq. Hold Command--Freq. output remains constant. |
| | 9 | Run Forward/ Reverse at Lower Limit Command--Frequency output decreases. The longer this input signal condition exists, the lower the output frequency becomes--limited only by constant An-01. |
| | 10 | Second Detent/ Freq. Hold Command--Freq. output remains constant. |
| | 11 | Run Forward/ Reverse Command--Frequency output decreases. The longer this input signal condition exists, the lower the output frequency becomes--limited only by constant An-01. |
| | 12 | Second Detent/ Freq. Hold Command--Freq. output remains constant. |
| | 13 | Absence of commands = STOP Command. Stopping method is selectable. (See section 6.2). |

**6.1.3.1 Input Terminal Status/ Output Frequency (Speed) Operation for
 3-Step Infinitely Variable mode**

Terminals X2~1 (2)	Terminals X2~5	Terminals X2~6	Output Freq. (Speed) Ref.
0	X	X	***STOP***
1	0	0	An-01
1	1	0	Frequency Hold Command
1	1	1	Frequency is Increasing

1 = 120VAC between Terms. of TC-GIF-5(4); 0 = 0VAC between Terms. of TC-GIF-5(4); X = Don't Care

*****IMPORTANT FACTS ABOUT "STOPPING Methods"*****

Factory initial value of Sn-04, Digit 2 is "1"--Immediate Stop. To Change to Deceleration at Stop Command, change Sn-04, Digit 2 to data "0". Extreme caution should be used when changing to "deceleration at Stop command". Operation should not begin until the user has reviewed the deceleration time found in constant Bn-02. A long deceleration time will cause driven equipment to require a greater stopping distance.

6.2 Stopping Method Definitions (Sn-04, Digit 2)

IMPULSE•G+ provides for both types of commonly accepted braking methods.

- Immediate Stop at STOP Command (Sn-04 Digit 2, Data "1")
- Decelerate at STOP Command (Sn-04 Digit 2, Data "0")

6.2.1 Immediate Stop At STOP Command

Upon STOP command, IMPULSE•G+ base blocks main output transistors (i.e. the motor is electrically disconnected from the drive) and the brake interlock relay (Terminals 9 ~ 10) sets the motor brake. See below timing chart for operation characteristics.

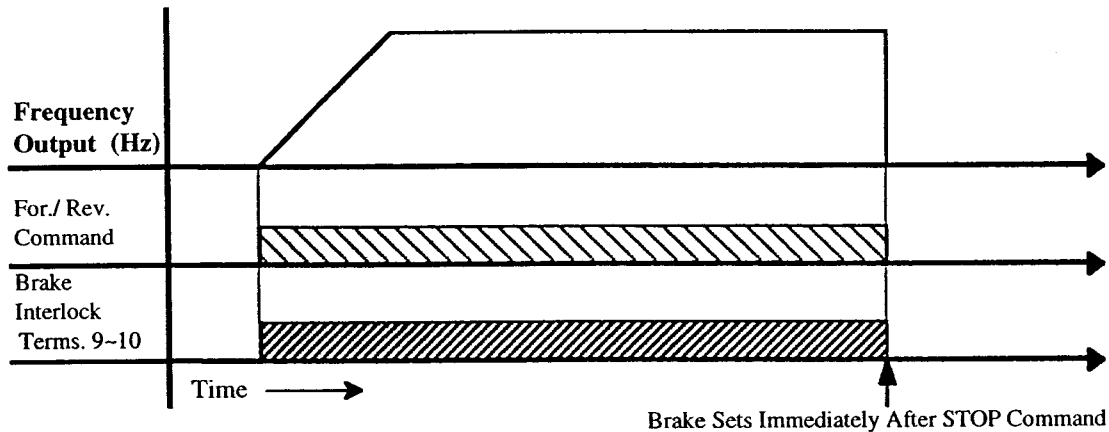

6.2.2 Decelerate At STOP Command

Upon STOP command, IMPULSE•G+ output frequency decreases to near zero, DC Injects for a few milliseconds, then the brake interlock relay (Terminals 9 ~ 10) sets the motor brake. See below timing chart for operation characteristics.

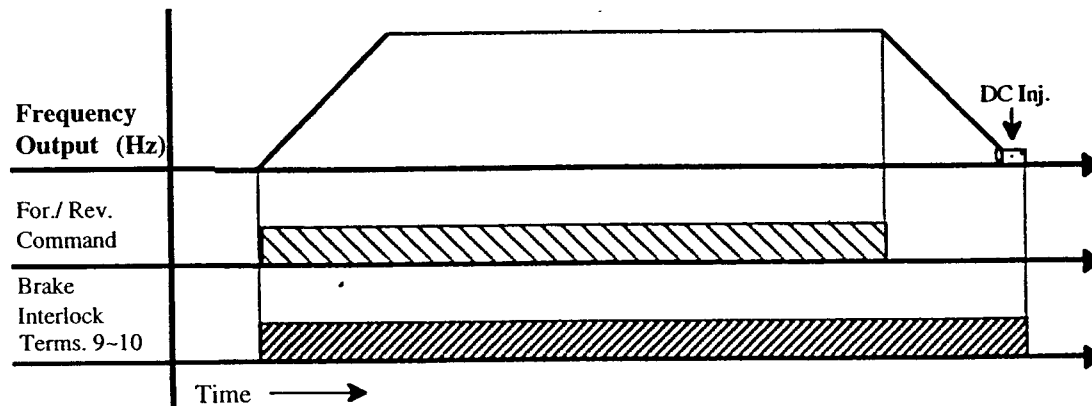

Customer Notes:

Customer Notes:

SECTION 7: SETTING RECIPES

7.1 Multi-Step Speed Control Method (Sn-10= "00")

Specific settings and control circuit connections are required to begin "Multi-Step Speed Control" operation. The "recipe" requires both control circuit connections and specific programming changes via the Digital Operator Keypad.

7.1.1 Control Circuit Wiring Diagram for Multi-Step Speed Control

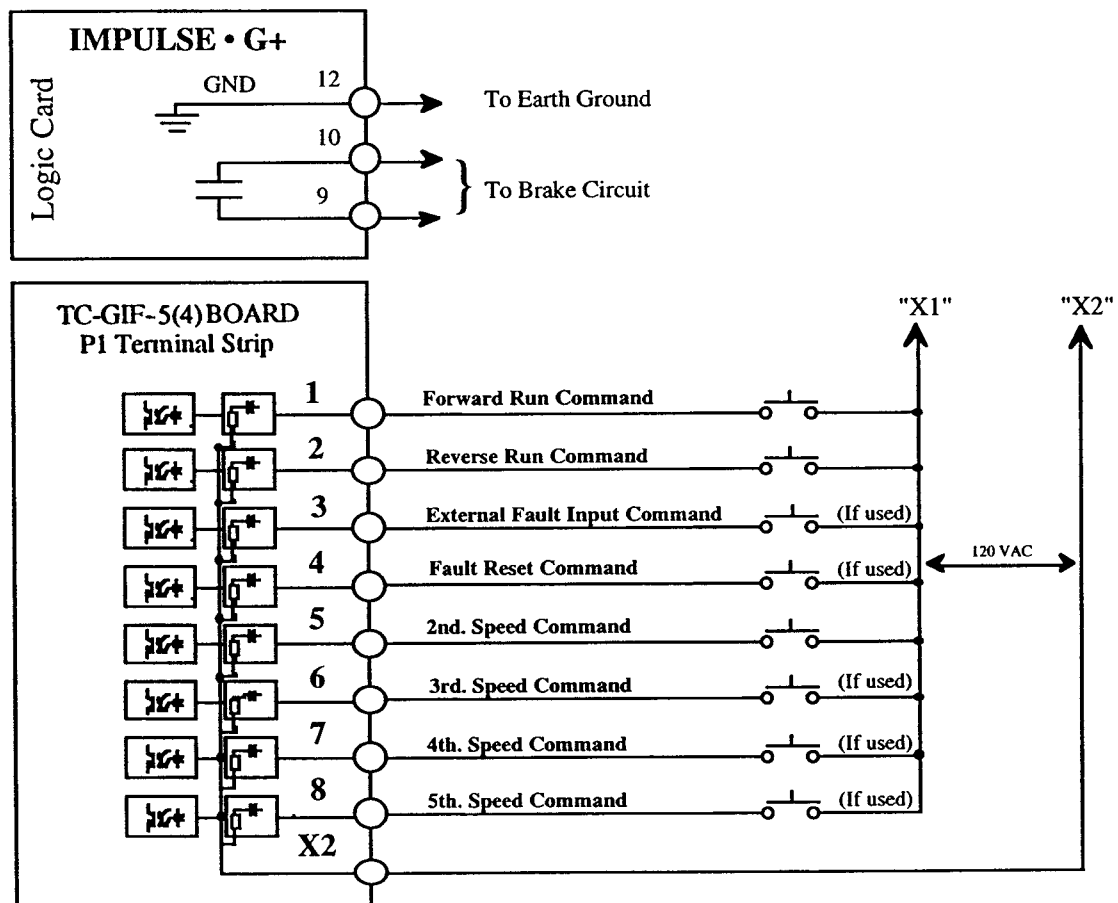

7.1.2 Control Circuit Input Sequence for Multi-Step Speed Control

Terminals Used For 5 Step Control					ACTION
Terminals Used For 4 Step Control				Terminals X2~8	
Terminals Used For 3 Step Control			Terminals X2~7		
Terminals X2~1 (2)	Terminals X2~5	Terminals X2~6			
0	X	X	X	X	***STOP***
1	0	0	0	0	Runs at An-01
1	1	0	0	0	Runs at An-02
1	1	1	0	0	Runs at An-03
1	1	1	1	0	Runs at An-04
1	1	1	1	1	Runs at An-05

1 = 120VAC between terms of TC-GIF-5(4); 0 = 0VAC between Terms. of TC-GIF-5(4); X = Don't Care

*****IMPORTANT FACTS ABOUT "STOPPING Methods"*****
 Factory initial value of Sn-04, Digit 2 is "1" --Immediate Stop. To Change to Deceleration at Stop Command, change Sn-04, Digit 2 to data "0". Extreme caution should be used when changing to "deceleration at Stop command". Operation should not begin until the user has reviewed the deceleration time found in constant Bn-02. A long deceleration time will cause drive equipment to require a greater stopping distance.

7.1.3 Suggested Values for Multi-Step Speed Points (An-01 ~ An-05)/ Initial Values (Note: The table below indicates speed points in Hz)

An-01	An-02	An-03	An-04	An-05
Suggested Values for 2 Step Control		Not Used	Not Used	Not Used
20.00	60.00			
Suggested Values for 3 Step Control			Not Used	Not Used
15.00	30.00	60		
Suggested Values for 4 Step Control				
6.00	15.00	45	60	
Suggested Values for 5 Step Control				
6.00	15.00	30	45	60
ELECTROMOTIVE SYSTEMS INITIAL VALUES				
6.00	15.00	30	45	60

7.1.4 Suggested Settings for Other Constants (Multi-Step Speed Control)

IMPORTANT NOTE 1:

The "Factory Initial Values" (See Section 5.0) derive from Electromotive Systems' vast experience in the Crane/Hoist industry. These values have been proven "typical" for the Crane/Hoist builder. Actual setting values should be determined by the specific application.

IMPORTANT NOTE 2:

Only those values "typically" changed from Electromotive Systems' Initial Values are indicated in the below table. Please read and understand Section 5 completely before proceeding with programming -- there may be constants and functions not listed below that will increase the application precision of **IMPULSE•G+**.

No.	Name	EMS Value	Bridge/Trolley	Hoist
Sn-03	Enables Changing of Constants		Data must be "0000"	
An-01	Multi-Step Speed 1/ Minimum Speed	6.00 Hz	See Section 7.1.2 (Depends on number of Speed Points)	
An-02	Multi-Step Speed 2	15.00 Hz		
An-03	Multi-Step Speed 3 (if used)	30 Hz		
An-04	Multi-Step Speed 4 (if used)	45 Hz		
An-05	Multi-Step Speed 5 (if used)	60 Hz		
Bn-01	Acceleration Time	5.0 Sec	User Specification	
Bn-02	Deceleration Time	3.0 Sec	User Specification	
Sn-02	V/F Pattern Selection	01	01	04
Sn-04	Stopping Method Selection	0010	***0000***	0010
Sn-10	Speed Control Method Selection	00	00	00
Cn-01	Input Voltage (Actual)	230/460	Input Volts	Input Volts
Cn-16	Motor Rated Current	#	Motor Amps	Motor Amps

Note: Depends upon **IMPULSE•G+** KVA Rating

*****IMPORTANT FACTS ABOUT "STOPPING Methods"*****

Factory initial value of Sn-04, Digit 2 is "1" --Immediate Stop. To Change to Deceleration at Stop Command, change Sn-04, Digit 2 to data "0". **Extreme caution should be used** when changing to "deceleration at Stop command". Operation should not begin until the user has reviewed the deceleration time found in constant Bn-02. A long deceleration time will cause drive equipment to require a greater stopping distance.

IMPORTANT NOTE 3:

Electromotive Systems software includes powerful and useful functions for Crane/Hoist applications. Be sure to completely read section 9.0 to apply these features and functions. The above table does not address these special features and functions.

Customer Notes:

7.2 Infinitely Variable Speed Control Method (2-Step Type) (Sn-10 = "04")

Specific settings and control circuit connections are required to begin "2-Step Infinitely Variable Speed Control" operation. The "recipe" requires both control circuit connections and specific programming changes via the Digital Operator keypad.

7.2.1 Control Circuit Wiring Diagram for Infinitely Variable Speed Control (2-Step Type)

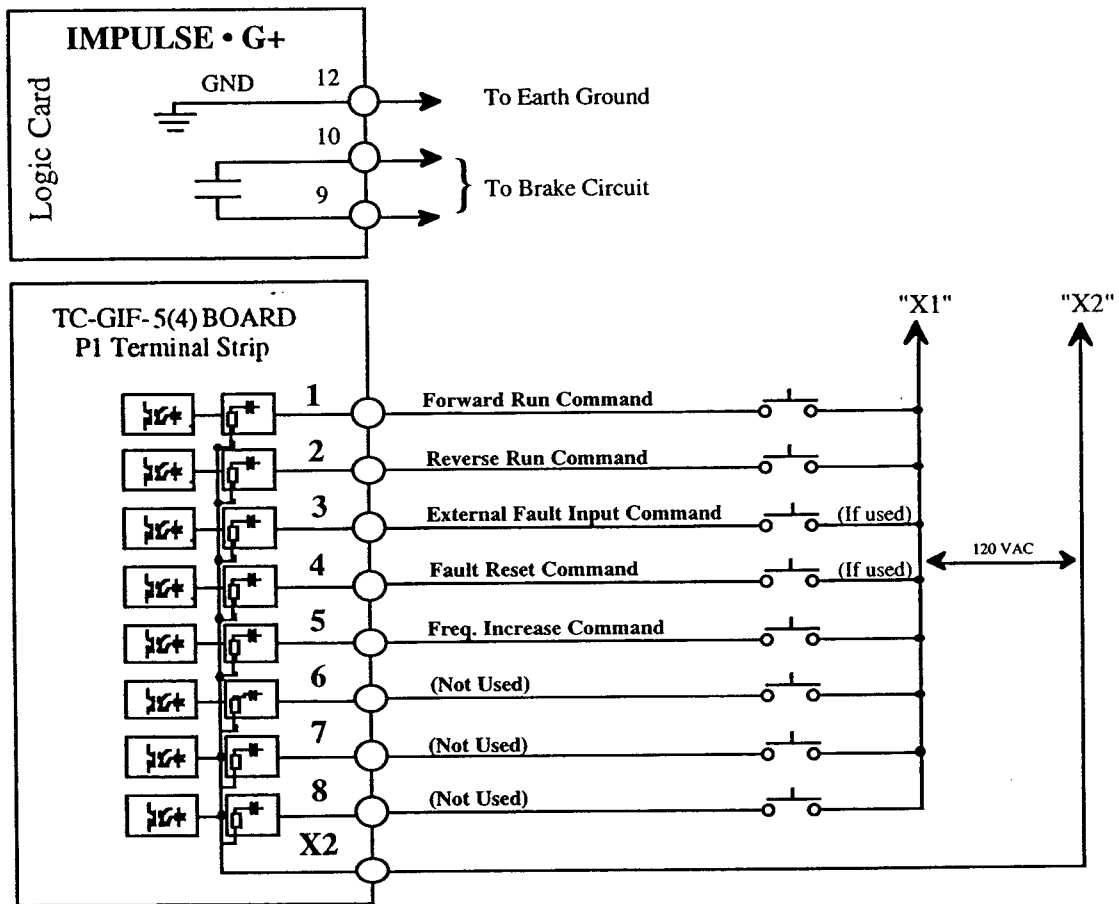

7.2.2 Input Terminal Status/ Output Frequency (Speed) for 2-Step Infinitely Variable Speed Control

Terminals X2~1 (2)	Terminals X2~5	ACTION
0	X	***STOP***
1	0	Runs at An-01/ Frequency Remains Constant
1	1	Frequency is increasing (limited by Cn-19)

1 = 120VAC between Terms. of TC-GIF-5(4); 0 = 0VAC between Terms. of TC-GIF-5(4); X = Don't Care

*****IMPORTANT FACTS ABOUT "STOPPING Methods"*****
 Factory initial value of Sn-04, Digit 2 is "1" --Immediate Stop. To Change to Deceleration at Stop Command, change Sn-04, Digit 2 to data "0". **Extreme caution should be used** when changing to "deceleration at Stop command". Operation should not begin until the user has reviewed the deceleration time found in constant Bn-02. A long deceleration time will cause drive equipment to require a greater stopping distance.

- **Note:** Changeover of An-01 Command/ Frequency Remains Constant is when F-Out = 0
- 1) First operation of terminal 1 (2) sfter F-Out = 0 commands speed of An-01.
 - 2) Subsequent operations of terminals 1 (2) commands "Frequency Hold".

7.2.3. Suggested Settings for Other Constants (2-Step Infinitely Variable Speed Control)

IMPORTANT NOTE 1:

The "Factory Initial (EMS) Values" (See Section 5.0) derive from Electromotive Systems' vast experience in the Crane/Hoist industry. These values have proven "typical" for the Crane/Hoist builder. Actual setting values should be determined by the specific application.

IMPORTANT NOTE 2:

Only those values "typically" changed from Electromotive Systems' Initial Values are indicated in the below table. Please thoroughly read and understand Section 5 before proceeding with programming -- there may be constants and functions not listed below that will increase the application precision of the **IMPULSE•G+**.

No.	Name	EMS Value	Bridge/Trolley	Hoist
Sn-03	Enables Changing of Constants	Data must be "0000"		
An-01	Multi-Step Speed 1/ Minimum Speed	6.00 Hz	User Specification	
Bn-01	Acceleration Time	5.0 Sec	User Specification	
Bn-02	Deceleration Time	3.0 Sec	User Specification	
Sn-02	V/F Pattern Selection	01	01	04
Sn-04	Stopping Method Selection	0010	***0000***	0010
Sn-10	Speed Control Method Selection	00	04	
Cn-01	Input Voltage (Actual)	230/460	Input Volts	
Cn-16	Motor Rated Current	#	Motor Nameplate Amps	
Cn-19	Maximum Speed (%F-Max(Cn-02))	100%	User Specification	

Note: Depends upon **IMPULSE•G+** KVA Rating

*****IMPORTANT FACTS ABOUT "STOPPING Methods"*****
 Factory initial value of Sn-04, Digit 2 is "1" --Immediate Stop. To Change to Deceleration at Stop Command, change Sn-04, Digit 2 to data "0". **Extreme caution should be used** when changing to "deceleration at Stop command". Operation should not begin until the user has reviewed the deceleration time found in constant Bn-02. A long deceleration time will cause drive equipment to require a greater stopping distance.

IMPORTANT NOTE 3:

Electromotive Systems software includes powerful and useful functions for Crane/Hoist applications. Be sure to completely read section 9.0 to apply these features and functions. The above table does not address these special features and functions.

Customer Notes:

7.3 Infinitely Variable Speed Control Method (3-Step Type) (Sn-10 = "03")

Specific settings and control circuit connections are required to begin "3-Step Infinitely Variable Speed Control" operation. The "recipe" requires both control circuit connections and specific programming changes via the Digital Operator keypad.

7.3.1 Control Circuit Wiring Diagram for Infinitely Variable Speed Control (3-Step Type)

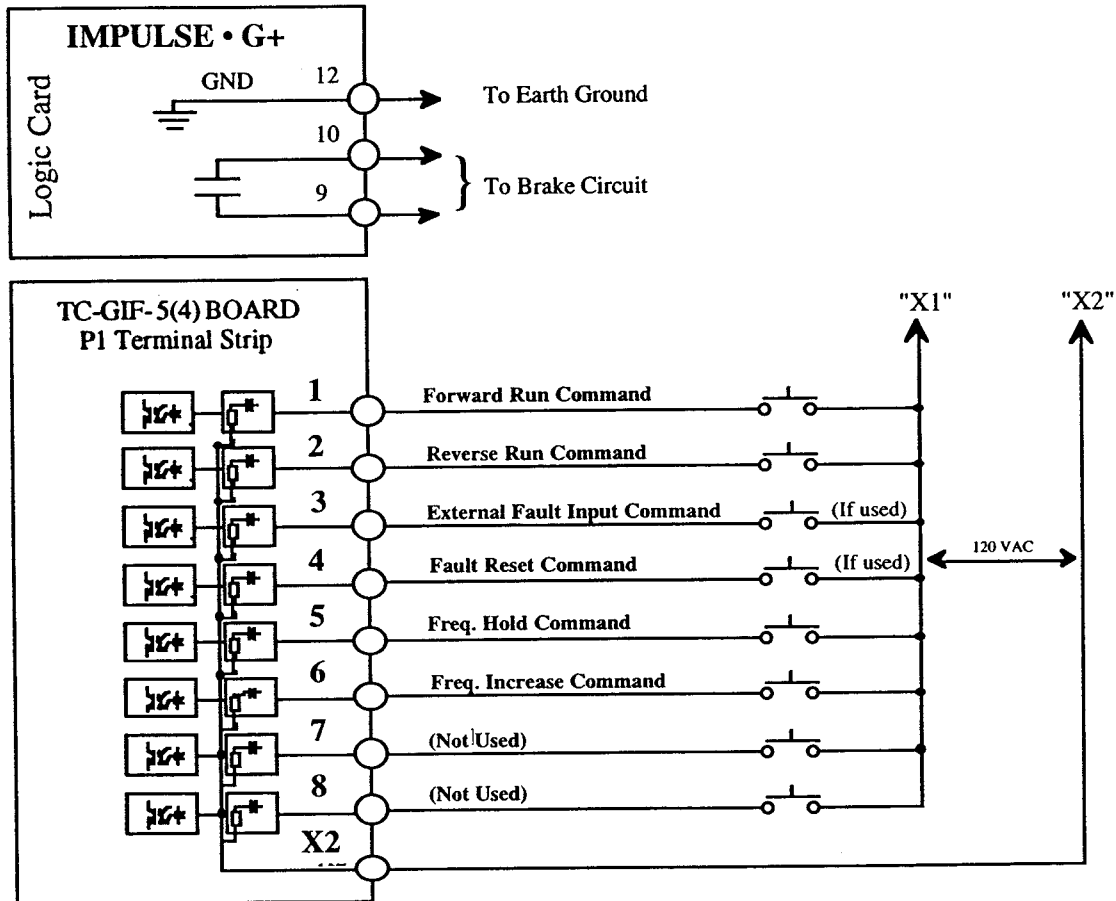

7.3.2 Input Terminal Status/ Output Frequency (Speed) for 3-Step Infinitely Variable Speed Control

Terminals X2~1 (2)	Terminals X2~5	Terminals X2~6	ACTION
0	X	X	***STOP***
1	0	0	Runs at An-01
1	1	0	Frequency Output is Constant
1	1	1	Frequency is Increasing

1 = 120VAC between Terms. of TC-GIF-5(4); 0 = 0VAC between Terms. of TC-GIF-5(4); X = Don't Care

*****IMPORTANT FACTS ABOUT "STOPPING Methods"*****

Factory initial value of Sn-04, Digit 2 is "1" --Immediate Stop. To Change to Deceleration at Stop Command, change Sn-04, Digit 2 to data "0". **Extreme caution should be used** when changing to "deceleration at Stop command". Operation should not begin until the user has reviewed the deceleration time found in constant Bn-02. A long deceleration time will cause drive equipment to require a greater stopping distance.

7.3.3. Suggested Settings for Other Constants (3-Step Infinitely Variable Speed Control)

IMPORTANT NOTE 1:

The "Factory Initial (EMS) Values" (See Section 5.0) derive from Electromotive Systems' vast experience in the Crane/Hoist industry. These values have proven "typical" for the Crane/Hoist builder. Actual setting values should be determined by the specific application.

IMPORTANT NOTE 2:

Only those values "typically" changed from Electromotive Systems' Initial Values are indicated in the table below. Please thoroughly read and understand Section 5 before proceeding with programming -- there may be constants and functions not listed below that will increase the application precision of the **IMPULSE•G+**.

No.	Name	EMS Value	Bridge/Trolley	Hoist
Sn-03	Enables Changing of Constants		Data must be "0000"	
An-01	Multi-Step Speed 1/ Minimum Speed	6.00 Hz	User Specification	
Bn-01	Acceleration Time	5.0 Sec	User Specification	
Bn-02	Deceleration Time	3.0 Sec	User Specification	
Sn-02	V/F Pattern Selection	01	01	04
Sn-04	Stopping Method Selection	0010	***0000***	0010
Sn-10	Speed Control Method Selection	00	03	
Cn-01	Input Voltage (Actual)	230/460	Input Volts	
Cn-16	Motor Rated Current	#	Motor Nameplate Amps	
Cn-19	Maximum Speed (%F-Max(Cn-02))	100%	User Specification	

Note: Depends upon **IMPULSE•G+** KVA Rating

*****IMPORTANT FACTS ABOUT "STOP Mode"*****

Factory initial value of Sn-04, Digit 2 is "1" --Immediate Stop. To Change to Deceleration at Stop Command, change Sn-04, Digit 2 to data "0". **Extreme caution should be used** when changing to "deceleration at Stop command". Operation should not begin until the user has reviewed the deceleration time found in constant Bn-02. A long deceleration time will cause drive equipment to require a greater stopping distance.







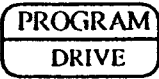

IMPORTANT NOTE 3:

Electromotive Systems software includes powerful and useful functions for Crane/Hoist applications. Be sure to completely read section 9.0 to apply these features and functions. The above table does not address these special features and functions.

SECTION 8- ADDITIONAL SETTINGS AND ADJUSTMENTS









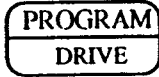

8.1 Acceleration Time

To change the acceleration ramp, you must change Bn-01. Assume the setting is 10.0 seconds. This is defined as the time it takes the motor to accelerate from zero speed to maximum speed. As an example, let's assume you would like to increase the accel time from 10.0 secs. to 15.0 secs. Follow the step-by-step procedure listed below:

-  display reads An-01, "Drive" LED on keypad goes out
-  display reads B n - 0 1
-  display reads 0 0 1 0 . 0
-  display reads 0 0 1 0 . 0
-  display reads 0 0 1 0 . 0
-  display reads 0 0 1 0 . 0
-  press until display reads 0 0 1 5 . 0
-  display momentarily reads "END", then returns to 0 0 1 5 . 0
-  keypad returns to DISPLAY mode it was in when you began this procedure.

8.2 Deceleration Time

To change the deceleration ramp, you must change Bn-02. Assume the setting is 10.0 seconds. This is defined as the time it takes the motor to decelerate from maximum speed to zero speed. As an example, let's assume you would like to increase the decel time from 10.0 secs. to 15.0 secs. Follow the step-by-step procedure listed below:

	display reads An-01, "Drive" LED on keypad goes out
	display reads B n - 0 1
	display reads B n - 0 2
	display reads 0 0 1 0 . 0
	display reads 0 0 1 0 . 0
	display reads 0 0 1 0 . 0
	display reads 0 0 1 0 . 0
	press until display reads 0 0 1 5 . 0
	display momentarily reads "END", then returns to 0 0 1 5 . 0
	keypad returns to DISPLAY mode it was in when you began this procedure.

8.3. Selection of Proper Volts/Hertz (V/F) Pattern

8.3.1 The importance of the proper relationship between voltage and frequency

The **IMPULSE•G+** unit varies the speed of the motor by varying the frequency of the power being applied to the motor. If you only vary the frequency without changing the motor voltage, the motor torque will vary greatly. To ensure the motor is capable of producing full load torque, the **IMPULSE•G+** must also vary the output voltage.

The motor was designed for operation at the voltage and frequency listed by the manufacturer on its nameplate. Maintaining the design relationship between voltage and frequency will allow the motor to produce design torque, without excessive heating. This design relationship is normally described by a Volts/ Hertz (V/F) ratio. Ideally, maintaining the design V/F ratio will maintain the magnetic fields within the motor at their design value, regardless of the speed of operation. The end result dictates that if you wish to operate a motor rated 460 VAC at 60 Hz at 1/2 speed, the output frequency must be half (30 Hz) and the output voltage will be half (230 VAC).

Because the voltage drop between the output terminals of **IMPULSE•G+** and the motor are particularly significant at lower frequencies, a small offset voltage must be applied to the motor if torque demands are high. This voltage offset is typically referred to as "voltage boost". To accommodate the differences between different motor designs, the amount of voltage boost must be variable.

The **IMPULSE•G+** was designed to make it very convenient to alter the motor's V/F pattern. All you need to do is select one of the 15 preset V/F patterns within the memory of the **IMPULSE•G+** by programming a value into constant Sn-02. The values comprising these patterns are the direct result of many years experience in meeting the harsh demands of the crane/ hoist application (the software of the unit also supports a custom pattern for ultimate flexibility, consult an ELECTROMOTIVE SYSTEMS applications engineer for details).

As you might expect, improper selection of the V/F pattern can result in loss of motor torque or excessive motor currents, so it's vital the proper pattern is selected. Please follow the basic guidelines given below:

1. The **IMPULSE•G+** must be used with a motor with a nameplate frequency of 60 Hz.
2. To minimize motor currents and heating, use the lowest amount of voltage boost that satisfies the starting/accelerating demands of your application.
3. Typically, a hoist application will require a higher voltage boost than a bridge or trolley application. Please refer to section 8.3.3 and 8.3.4 for more details.

The table shown on the next page details the endpoints of the various preset V/F patterns. If your application involves a horizontal motion, please refer to section 8.3.3. If your application is a load brake type hoist, please refer to section 8.3.4 for related details.

8.3.1 The importance of a proper Volts/Hertz (V/F) pattern (Continued)

ITEM/ Sn-02 Data	00	01	02	03	04	05	06	07
Max. Frequency (Cn-02)	60.0	60.0	60.0	60.0	60.0	60.0	60.0	60.0
* Max. Voltage (Cn-03)	230	230	230	230	230	230	230	230
Freq. @ Max. Voltage (Cn-04)	60.0	60.0	60.0	60.0	60.0	60.0	60.0	60.0
Breakpoint Frequency (Cn-05)	3.0	3.0	3.0	3.0	3.0	3.0	3.0	3.0
* Breakpoint Voltage (Cn-06)	14.9	16.1	17.2	18.4	19.5	20.7	21.8	23
Min. Output Freq. (Cn-07)	1.5	1.5	1.5	1.5	1.5	1.5	1.5	1.5
* Min. Output Volt. (Cn-08)	8	9.2	10.3	11.5	12.6	13.8	14.9	16.1

ITEM/ Sn-02 Data	08	09	0A	0B	0C	0D	0E	0F
Max. Frequency (Cn-02)	60.0	60.0	60.0	72.0	72.0	60.0	60.0	60.0
* Max. Voltage (Cn-03)	230	230	230	230	230	230	230	200
Freq. @ Max. Voltage (Cn-04)	60.0	60.0	60.0	60.0	60.0	60.0	60.0	50.0
Breakpoint Frequency (Cn-05)	3.0	3.0	3.0	3.0	3.0	6.0	6.0	3.0
* Breakpoint Voltage (Cn-06)	24.1	25.3	26.4	14.9	26.4	23	23	35
Min. Output Freq. (Cn-07)	1.5	1.5	1.5	1.5	1.5	1.5	1.5	1.5
* Min. Output Volt. (Cn-08)	17.2	18.4	20.7	8	20.7	8	20.7	35

* NOTE: Values shown in table are for 230 VAC input units (Cn-01 = 230). For 460 VAC applications (Cn-01 = 460), all voltage values listed above are doubled.

Typical V/F pattern shown graphically

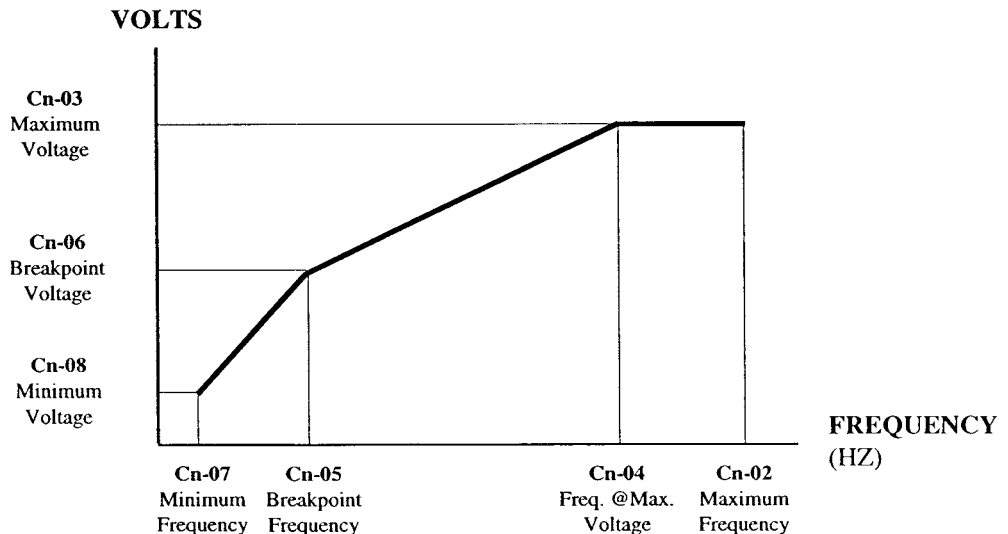

8.3.2. Programming of Input Voltage into Inverter

The IMPULSE•G+ unit has a built-in, output voltage regulator function. To precisely match the inverter's output voltage with the desired voltage, you should always verify the setting of the constant designated as the AC input voltage level. This parameter is found in CONTROL constant Cn-01 and should be checked at the time of start-up.

To properly set this input voltage parameter, you will need to measure the three-phase input voltage into the inverter (at terminals L1, L2, L3) and take the average of the three phases as the desired value of Cn-01. As an example, suppose you measure 230 VAC and Cn-01 is set at 200. To change the setting of Cn-01 for 230 VAC input please follow the procedure given below.

PROGRAM DRIVE	display reads An-01, "Drive" LED on keypad goes out
DISPLAY	display reads B n - 0 1
DISPLAY	display reads S n - 0 1
DISPLAY	display reads C n - 0 1
DATA ENTER	* display reads 0 2 0 0 . 0
> RESET	display reads 0 2 0 0 . 0
> RESET	display reads 0 2 0 0 . 0
^	press until display reads 0 2 3 0 . 0
DATA ENTER	display momentarily reads "END", then returns to 0 2 3 0 . 0
PROGRAM DRIVE	keypad returns to DISPLAY mode it was in when you began this procedure.

** Note: Given value is for a 200- 230 VAC IMPULSE•G+. If you are using a 380- 460 VAC unit, the values will be doubled.*

8.3.3. Programming of Volts/ Hertz (V/F) Pattern for HORIZONTAL Motions

The initial factory setting for the V/Hz pattern parameter is Sn-02 = 01. This pattern is suitable for most horizontal motion applications, provided you have followed the correct procedure for the setting of the Input Voltage (Cn-01) described in section 8.3.2.

If you have problems in starting or in accelerating the load in the desired time, you may wish to try one of the following settings (remember, select the lowest numbered pattern which satisfies your needs):

Initial Setting	Sn-02= 01
First change to	Sn-02= 02
Second change to	Sn-02= 03
Third change to	Sn-02= 04

If none of these settings seem to work satisfactorily, please contact an applications engineer at ELECTROMOTIVE SYSTEMS for assistance.

Alternatively, if you experience excessive motor heating or Overcurrent (OC) fault trips, please contact an applications engineer.

8.3.4. Programming of Volts/ Hertz (V/F) Pattern for MECHANICAL LOAD BRAKE HOIST Motions

The initial factory setting for the V/Hz pattern parameter is Sn-02= 01. **This pattern is not suitable for most hoisting applications.**

<p>CAUTION: Before you try to operate the IMPULSE•G+ on a hoist application you must first change the setting of constant Sn-02 from "01" to "04". Failure to do this may result in difficulties in lifting a load.</p>

If you have not checked the setting of the input voltage parameter (Cn-01) you should now refer to section 8.3.2. for a detailed account of how to properly set this parameter. Failure to do so will result in difficulties in handling the load.

Initial Setting	Sn-02= 01
you MUST change to	Sn-02= 04
Second change to	Sn-02= 05
Third change to	Sn-02= 06

If none of these settings seem to work satisfactorily, please contact an applications engineer at ELECTROMOTIVE SYSTEMS for assistance.

Alternatively, if you experience excessive motor heating or Overcurrent (OC) fault trips, please contact an applications engineer.

8.4. To Enable/ Disable Electronic Motor Thermal Overload Protection

The **IMPULSE•G+** contains a sophisticated software algorithm which actually monitors the motor's operating conditions (current and speed) over a period of time. This data is used in a motor thermal simulation within the inverter, so the inverter is continuously checking for possible motor overload conditions. There are two programming constants which should be set to tune this motor protection. These are Protective Characteristics (Sn-08) and Motor Rated Current (Cn-16).

The factory setting for this motor overload protection is **ENABLED**. We suggest you leave this protective function enabled. However, should you choose to disable this function set Sn-08 Digit 1= 1 and install separate motor thermal overload relays or motor klixons/thermistors for each individual motor (per NEC requirements).



Protective Characteristics (Sn-08): FACTORY SETTING= 0000.

Digit 1	Motor Overload Enable/ Disable	0	Function is ENABLED
		1	Function is DISABLED
Digit 2	Motor Type	0	TEFC - Fan-cooled (function of rotor RPM's)
		1	TENV- Non-Ventilated or cooled by constant velocity fan.
Digit 3	Not related to this function	X	Don't Care
Digit 4	Not related to this function.	X	Don't Care

Motor Rated Current (Cn-16): FACTORY SETTING = Dependent Upon Inverter Rating

This programming constant should be set to match the motor's actual nameplate current. This is analagous to selecting the proper heater element for a conventional motor overload relay.

Please refer to the following page for an application example with a simple step-by-step procedure you can use to tune this function.

**8.4. To Enable/Disable Electronic Motor Thermal Overload Protection
(Continued)**

As an example, suppose your application is on a 10 HP, 460 VAC mechanical load brake hoist. Furthermore, suppose your motor nameplate reads 13.2 amps. The initial value of Cn-16 for a 460VAC, 10 HP **IMPULSE•G+** is 13.3 Amps*. Therefore, we would ideally like to set Cn-16 = the actual motor nameplate full load amps. To change the setting of Cn-16, please follow the procedure listed below.

PROGRAM DRIVE	display reads An-01, "Drive" LED on keypad goes out
DISPLAY	display reads B n - 0 1
DISPLAY	display reads S n - 0 1
DISPLAY	display reads C n - 0 1
^	press until display reads C n - 16
DATA ENTER	display reads 0 0 1 3 . 3
> RESET	press until display reads 0 0 1 3 . 3
v	display reads 0 0 1 3 . 2
DATA ENTER	display momentarily reads "END", then returns to 0 0 1 3 . 2
PROGRAM DRIVE	keypad returns to DISPLAY mode it was in when you began this procedure.

* Note: This particular factory setting is true for a 10 HP, 460 VAC unit. The actual value of Cn-16 will be dependent upon the inverter's rating.

Customer Notes

Customer Notes:

Customer Notes:

SECTION 9: SPECIAL FEATURES OF IMPULSE•G+

As described earlier within this instruction manual, **IMPULSE•G+** is a unique combination of hardware and software tailored to provide safe/optimum performance for overhead material handling applications. This section describes powerful and unique features of **IMPULSE•G+** adjustable frequency drives.

- * **Simple Safety Features of IMPULSE•G+**
 - * STOP Button Operation
 - * RUN Button Operation
 - * Automatic Keypad Lockout™

- * **Special Safety Features of IMPULSE•G+**
 - * LOAD CHECK™ Function for Hoist Applications
 - * Minimum Base Block Time for Conical Rotor Motor Hoists

- * **Application Features of IMPULSE•G+**
 - * Automatic Alternate Accel/Decel Time Changeover
 - * Automatic Alternate Decel Time Changeover
 - * QUICK STOP™
 - * REVERSE PLUG SIMULATION™
 - * END OF TRAVEL LIMIT™
 - * SWIFT LIFT™

9.1 Simple Safety Features of IMPULSE•G+

9.1.1 STOP Button Operation

The STOP button on the Digital Keypad is always "active" (both in the Drive and PROGRAM modes) in **IMPULSE•G+**. Upon depression of the STOP button, the drive stops according to the programmed stopping method (Sn-04 Digit 2).

 = STOP according to Sn-04 Digit 2

9.1.2 RUN Button Operation

The RUN button found on the Digital Keypad of the **IMPULSE•G+** operates differently than that typical of "General Purpose" inverters. Safe operation of Cranes/Hoists in the "local operation" mode demands that frequency output only be possible when the RUN button is depressed. The absence of RUN button depression demands STOP (according to the programmed stopping method, Sn-04 Digit 2). Operation is described below:

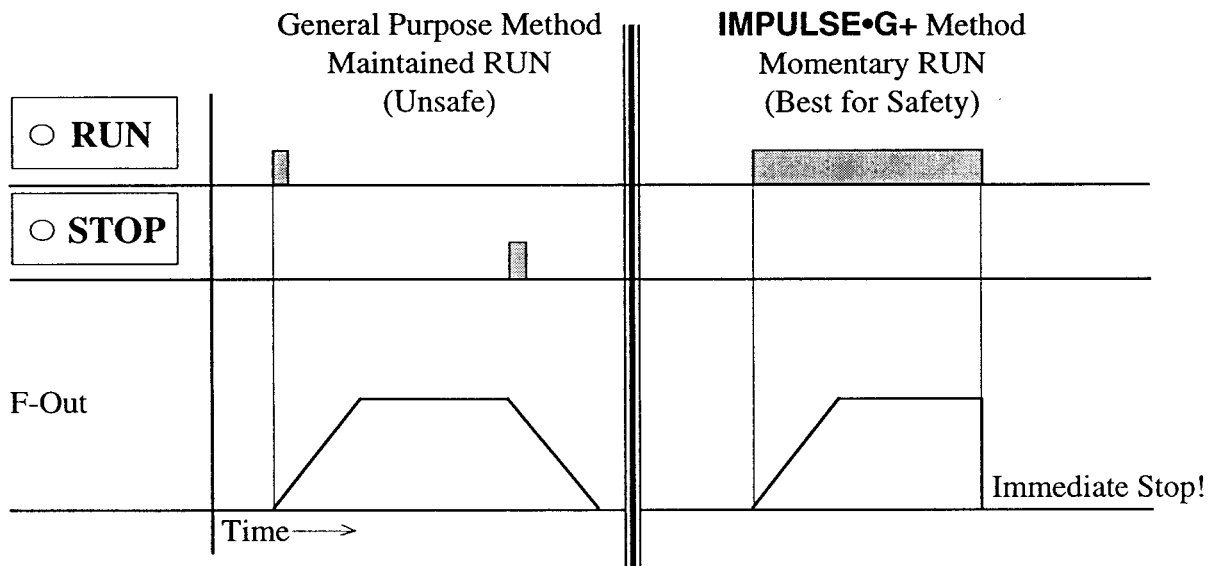

9.1.3 Automatic Keypad Lockout™ (Sn-03 = 0101 at "Power-Up"-- All Sn and Cn data can only be read, not changed)

IMPULSE•G+ employs a unique software function to automatically prohibit the user from making unnecessary data changes. Even in the case of service personnel overlooking the resetting of Sn-03 to data "0101", the **IMPULSE•G+** automatically re-initializes this value upon next "Power-Up".

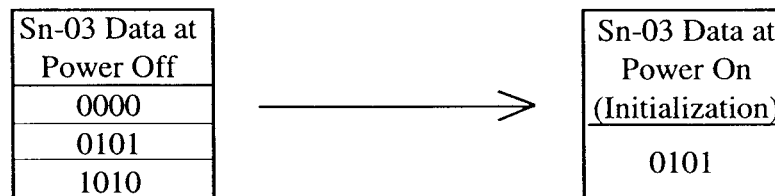

9.2 Special Safety Features of IMPULSE•G+

9.2.1 LOAD CHECK™ Function for Hoisting - PATENT PENDING

Every piece of Crane/Hoist equipment has a clearly marked "Capacity", generally expressed in Tons. The clearest hazard recognized among Crane/ Hoist users is application of the equipment beyond the intended "Rated Load". Methods exist to protect against overloading the equipment, but these others systems require expensive and cumbersome hardware. Unique to **IMPULSE•G+** is Load Check. Load Check performs the function similar to a load limiting device and helps to ensure that the "Rated Capacity" of the hoist is not exceeded.

9.2.1.1 Underlying Ideas of LOAD CHECK™ Function

- 1) Current is almost always proportional to load at constant running.
- 2) Detection is only possible during constant running because of the normal increase of current while accelerating.
- 3) To insure safety, detection must take place as soon as possible.
- 4) To prevent "runaway" due to regenerative torque during lowering, the maximum speed of lowering must be limited ($F = ma$).

9.2.1.2 Diagram of Output Current vs. Output Frequency

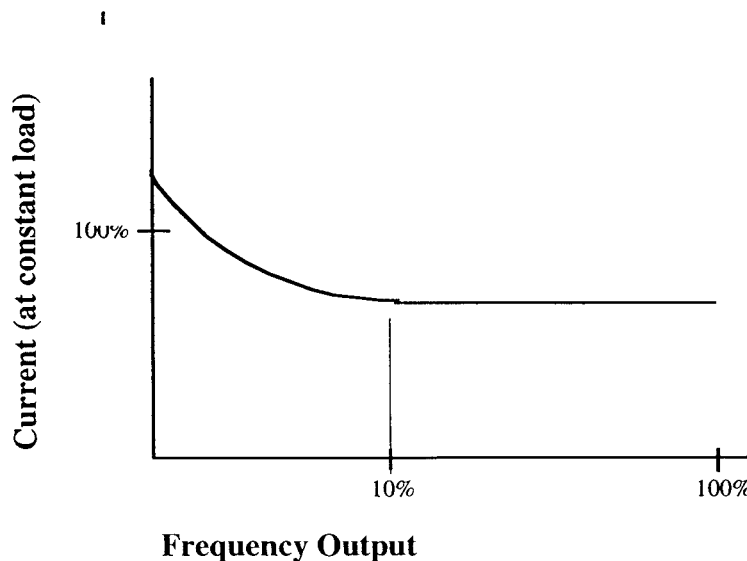

9.2.1.3 LOAD CHECK™ Detection Method Timing Chart

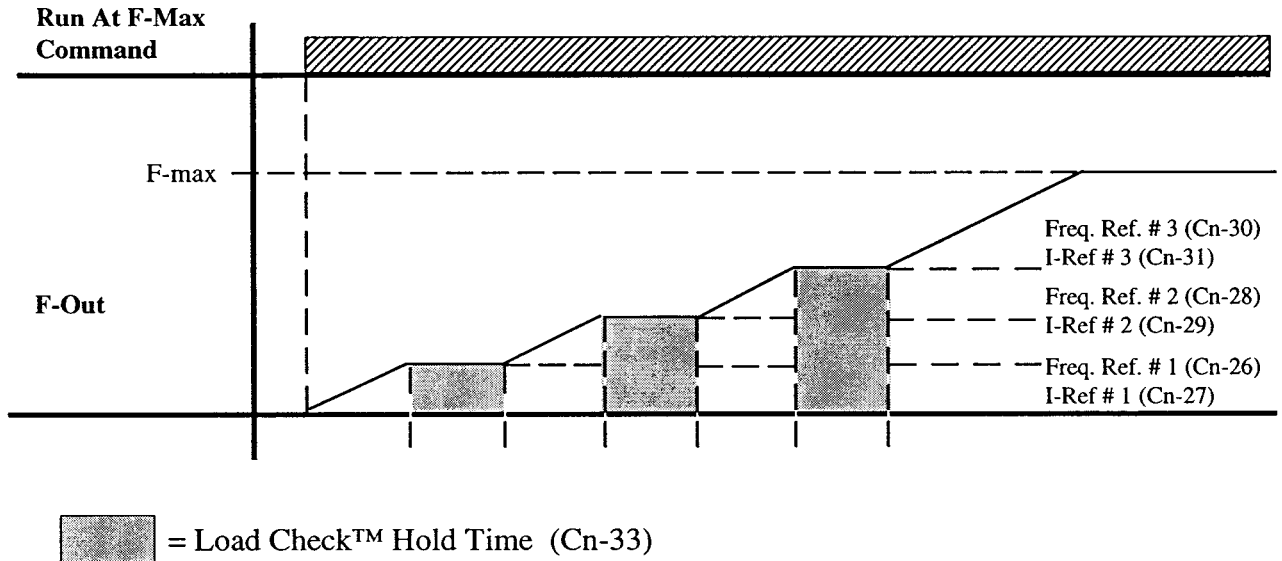

If Output Current (I-Out) \geq Load Check Current (Cn27/29/31) for Load Check Detection Time (Cn-32), then **IMPULSE•G+** base blocks (major fault). Forward operation is disabled. Reverse operation is enabled at \leq 10% Maximum (Cn-19).

9.2.1.4 LOAD CHECK™ Flow Chart

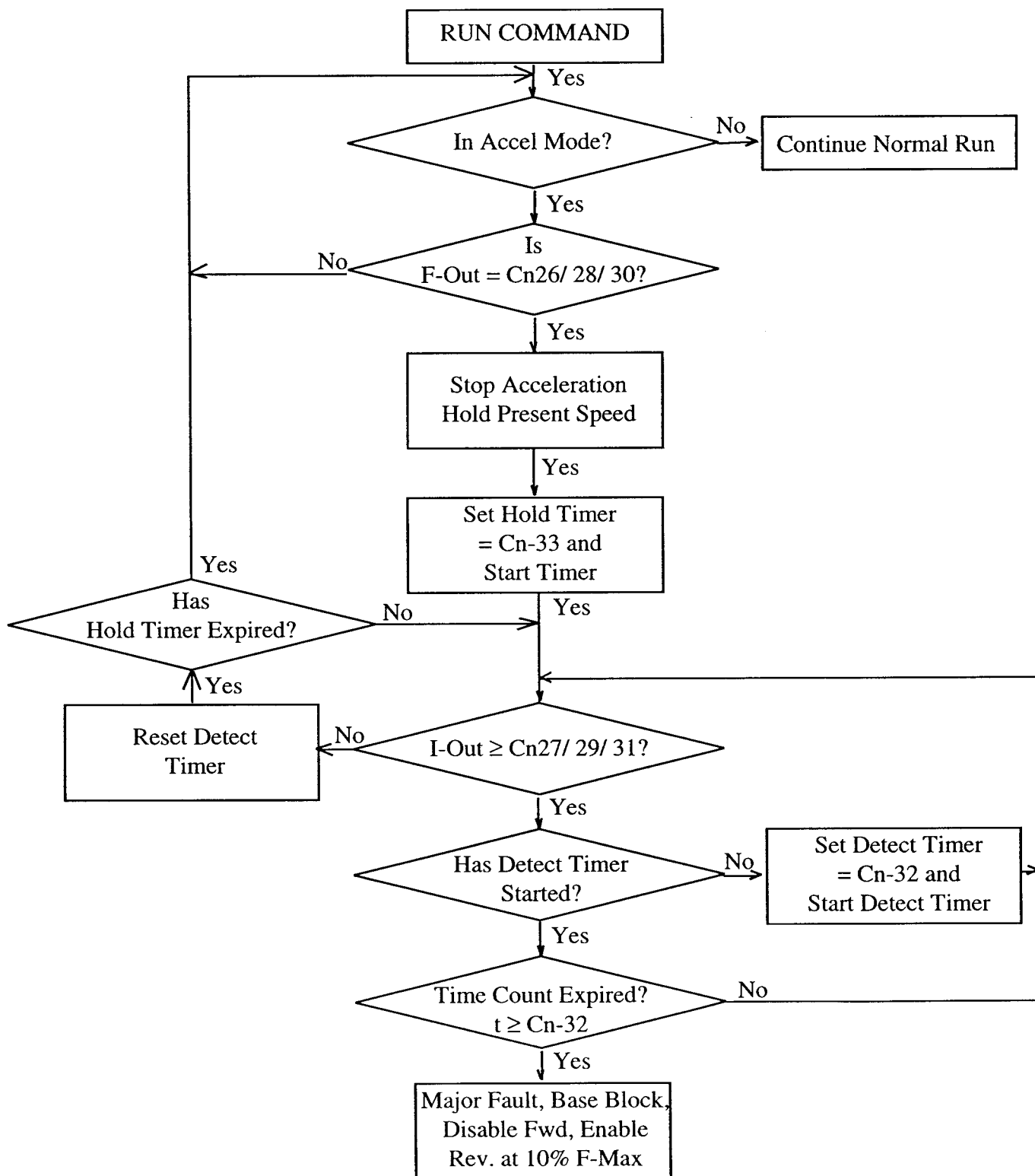

9.3 Minimum Base Block Time for Hoists (Cn-23 Function)

Some hoists do not employ conventional mechanical load brakes. As such, complete stopping must be accomplished during reversing operation via other means. Minimum Base Block Time (Cn-23) is applied as below:

9.3.1 Timing Chart for Cn-23 Function

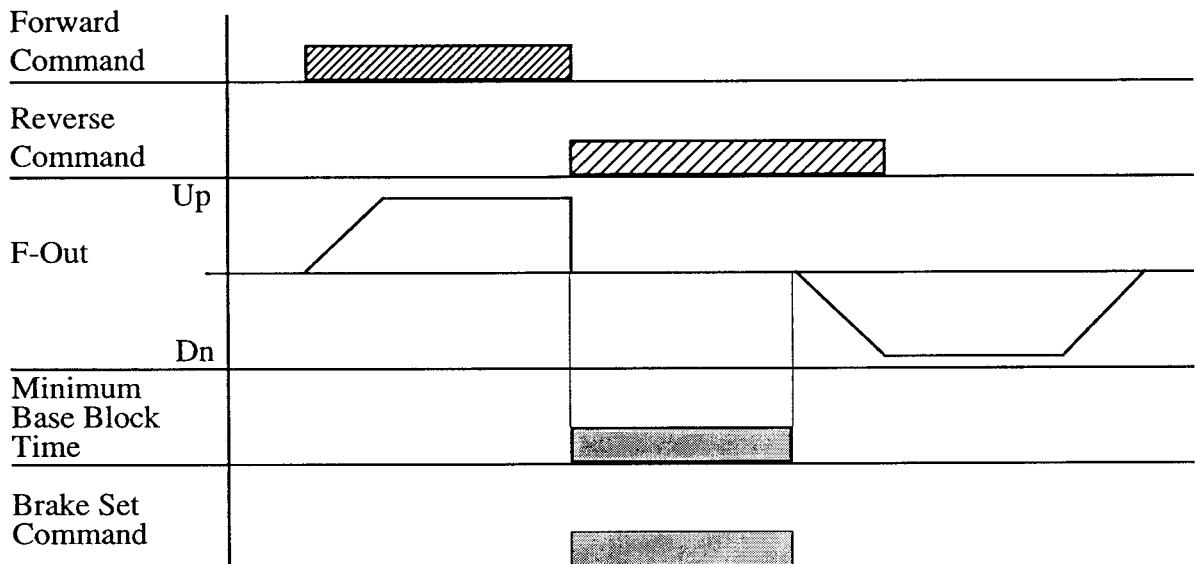

9.3.2 Programming Method

Disabled by Cn-23 = 0.0 Second (Typical horizontal setting)

Enabled by Cn-23 = 2.0 Seconds (Typical hoist setting)

Note: Actual setting data will depend upon the electro-mechanical system

9.4 Automatic Alternate Accel/ Decel Time Changeover

Electromotive Systems' unique Automatic Alternate Accel/Decel Time Changeover function provides for increased performance where output speeds in excess of "motor base speed" are required.

9.4.1 Background of Function:

At frequencies above base frequency (60 Hz), the output voltage is clamped (at V-in). Due to the limiting of voltage, the motor's torque capability above base speed is diminished. The decreasing torque capability of the motor applies to both driving and retarding torque. Since acceleration and deceleration time depends upon the torque of the motor, the acceleration time and deceleration time constants must correspond to the "worst case" output torque condition. Recognizing that the worst case condition only exists above base speed, the automatic alternate Accel/Decel Time changes priority of Bn-01/ Bn-03-- Bn-02/ Bn-04 at saturation frequency (Cn-04). Given this unique solution, the optimum acceleration and deceleration is possible both above and below base speed.

9.4.2 Programming method:

Function is enabled by Sn-09, digits 4 & 3 = data "00"

Bn-01 = Acceleration time for the Output Frequencies \leq Cn-04

Bn-02 = Deceleration time for the Output Frequencies \leq Cn-04

Bn-03 = Acceleration time for the Output Frequencies $>$ Cn-04

Bn-04 = Deceleration time for the Output Frequencies $>$ Cn-04

9.4.3 Timing Chart

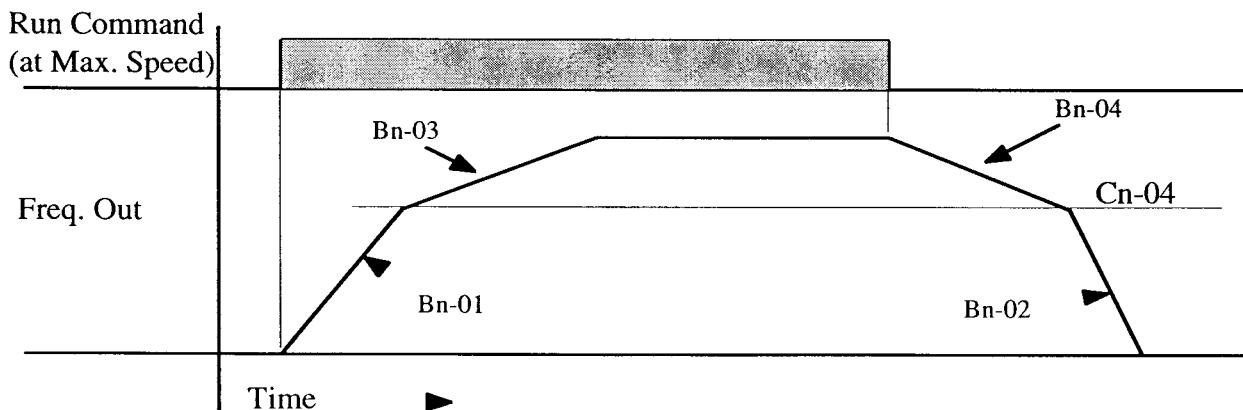

9.5 Automatic Alternate Decel Time Changeover (Change at Cn-14/15)

Electromotive Systems' unique Automatic Alternate Decel Time Changeover function provides for increased performance for the Crane/Hoist user. This function can be utilized in two basic ways:

- * To provide for "soft landing" in precision positioning.
- * To increase deceleration performance/decrease positioning time.

9.5.1 Background of Function:

Deceleration time is determined by both inverter capability and user demands for smooth and accurate operation. This demand for smooth operation and the contrary demand for short operating cycles further complicate the equation. The deceleration time changeover function at the frequency of Cn-14/15 accomodates these demands.

9.5.2 Programming method:

Function is enabled by Sn-09, digits 4 & 3 = data "01"

Bn-01 = Acceleration time

Bn-02 = Deceleration time for the Output Frequencies \leq Cn-14/ 15

Bn-05 = Deceleration time for the Output Frequencies $>$ Cn-14/ 15

Cn-14 = Deceleration time changeover frequency for FWD. direction

Cn-15 = Deceleration time changeover frequency for REV. direction

9.5.3 Timing Chart

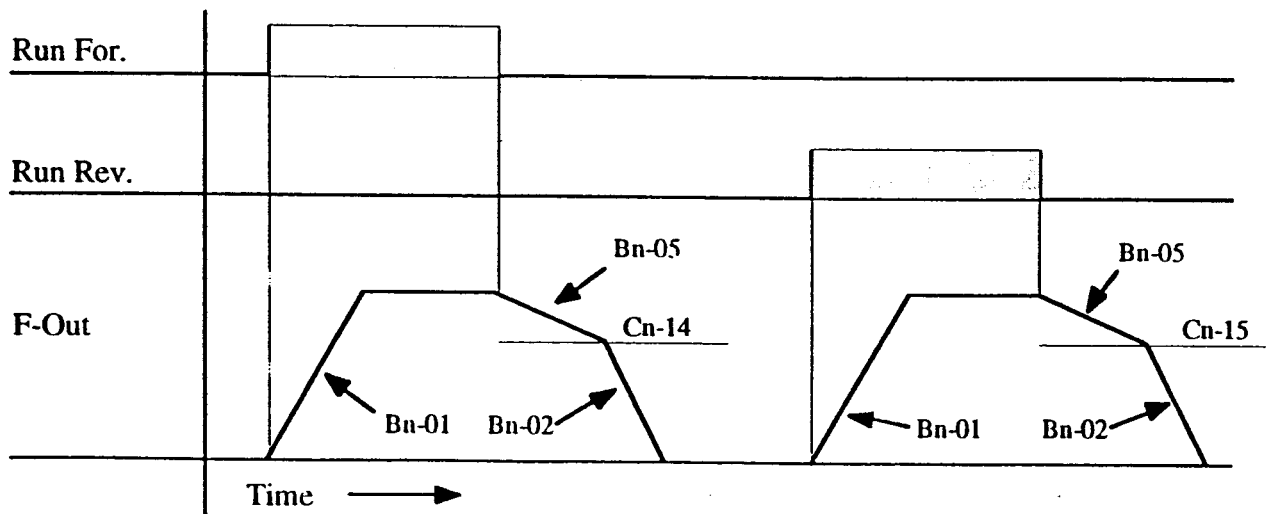

9.6 QUICK STOP™ - PATENT PENDING

Electromotive Systems' unique QUICK STOP provides an automatic alternate decel time changeover at STOP command. This function provides for increased positioning accuracy and shortens the deceleration time at STOP command to within the safe operating limits of the equipment.

9.6.1 Background of QUICK STOP Function:

Customers have requested that the deceleration time at STOP command be quicker (different) than the deceleration time during normal speed changes. This new function accomodates these requests.

9.6.2 QUICK STOP Programming Method:

Function is enabled by Sn-09, digits 4 & 3 = data "10"

Bn-01 = Acceleration time

Bn-02 = Deceleration time for Speed Changing

Bn-04 = Deceleration time at STOP command

9.6.3 QUICK STOP Timing Chart

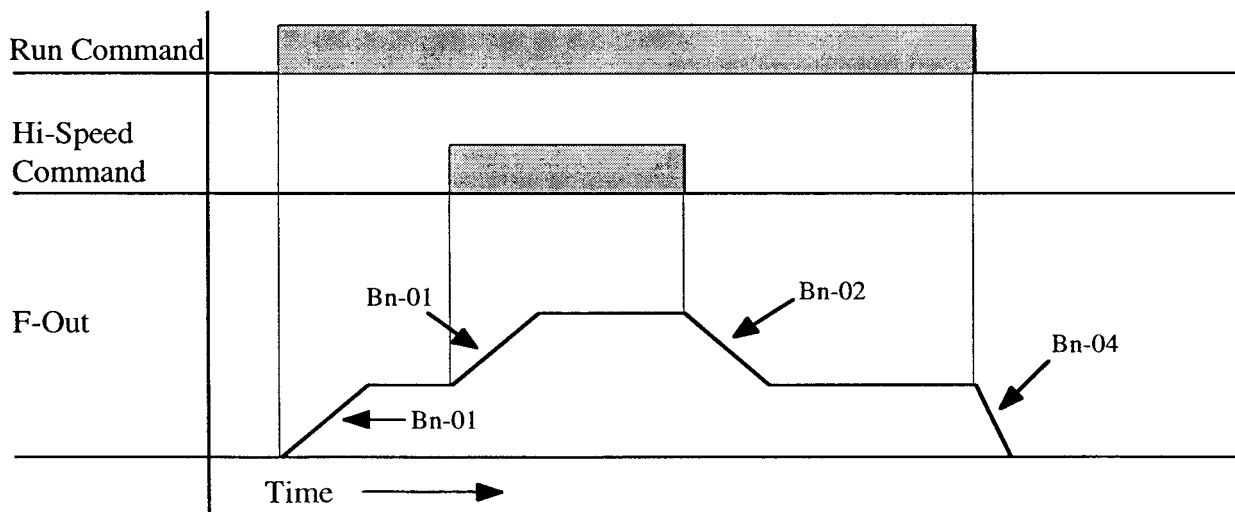

9.7 REVERSE PLUG SIMULATION™ - PATENT PENDING

Electromotive Systems' unique REVERSE PLUG SIMULATION function provides for rapid reversal of motor direction (or quicker deceleration at Reverse Plug command). This function closely simulates the operation of systems utilizing conventional reversing contactor type control so as to make operation of equipment more consistent.

9.7.1 Background of REVERSE PLUG SIMULATION Function:

Customers have requested the inverter drive systems offer the same rapid response at Plug Reverse command as that found with conventional reversing contactor controls. The operator is "comfortable" with the rapid deceleration attained when plug reversing standard motors. If an "opposite direction" command is received during deceleration, the alternate acceleration/ deceleration is applied. REVERSE PLUG SIMULATION provides this function.

9.7.2 REVERSE PLUG SIMULATION Programming method:

Function is enabled by Sn-09, digits 4 & 3 = data "11"

Bn-01 = Acceleration time

Bn-02 = Deceleration time

Bn-03 = Acceleration time at REVERSE PLUG SIMULATION

Bn-04 = Deceleration time at REVERSE PLUG SIMULATION

9.7.3 REVERSE PLUG SIMULATION Timing Chart

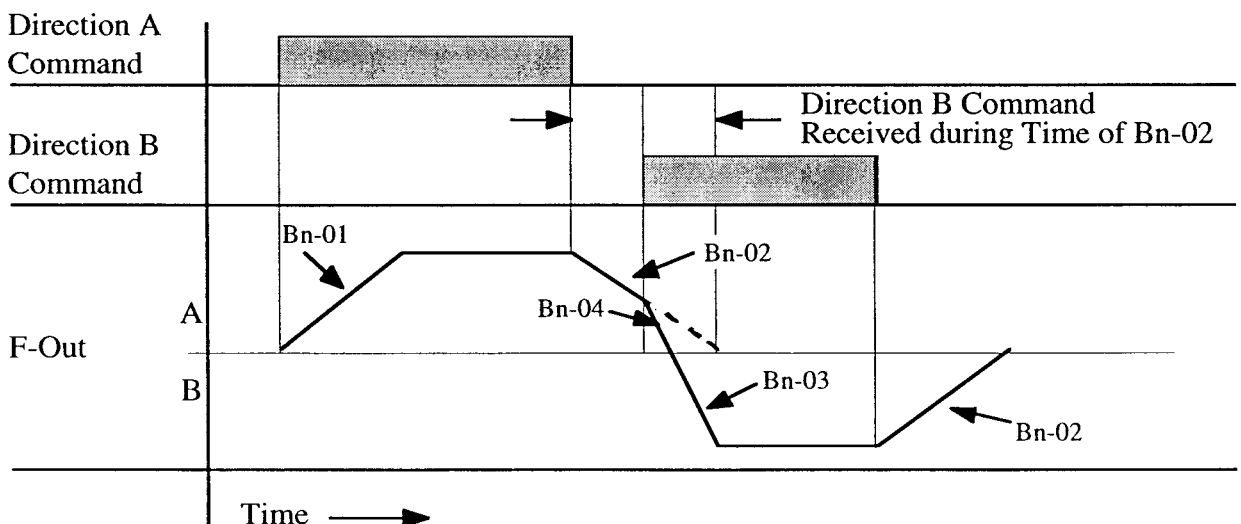

9.8 END OF TRAVEL LIMIT™ Function

Electromotive Systems' unique END OF TRAVEL LIMIT function allows a single command to enable the special sequences simulating an "end of travel" limit switch (maintained) serving both directions of movement.

9.8.1 Background of END OF TRAVEL LIMIT Function:

Customers have requested Electromotive Systems to simplify the wiring required for the Upper/Lower limit function for hoists, as well as the FWD/REV limit for horizontal motions.

9.8.2 END OF TRAVEL LIMIT Programming method:

Function is enabled by Sn-11 ~ Sn-14 = data "05" (The actual Sn constant that is used is dependent on which input terminal [3, 4, 7 or 8] is selected to serve as the End of Travel Limit input).

9.8.3 END OF TRAVEL LIMIT Timing Chart

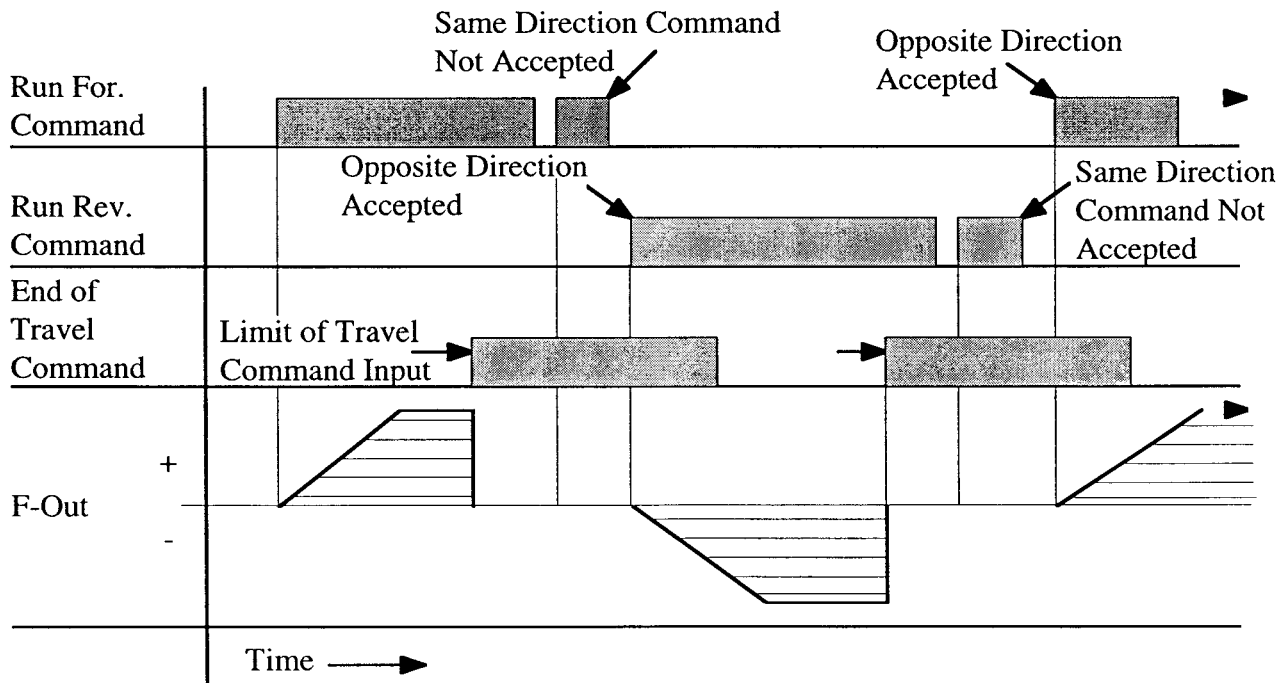

9.9 SLIP COMPENSATION

Physical characteristics of a squirrel cage induction motor require it to run slower than the synchronous speed by an amount which allows sufficient current to be induced in the rotor to produce the torque required by the load. This difference between synchronous speed (N_s) and actual running speed (N_a) is known as slip. Hence the slip equation is $Slip = N_s - N_a$. Slip is expressed in both RPM and in % of synchronous speed.

As an example, consider a 4-pole induction motor excited at 60 Hz. Its synchronous speed would be 1800 rpm. However, its nameplate gives its rated HP at 1750 rpm. This represents a slip of 50 rpm or approximately 2.8%. Most squirrel cage motors require a slip of approximately 50 rpm to develop full load torque.

Slip compensation is a feature that will enable the motor to run at rated speed regardless of load. (Under no circumstance should the load exceed the full-load rating of the crane.)

9.9.1 SLIP COMPENSATION programming method:

Function is enabled by $S_n-09 = XXX1$.

C_n-41 = Slip compensation delay time (typically set between 0.2 -0.5 seconds)

B_n-09 = Percent motor slip

9.10 SWIFT LIFT™ Overspeed Operation - PATENT PENDING

Electromotive Systems' unique SWIFT LIFT Overspeed Operation function automatically provides for increased speed of operation under light (or no load) conditions.

9.10.1 Background of Function:

Competing DC drives for hoists and cranes have always offered extended speed ranges via field weakening. While this function of DC drives has never been automated, the feature can offer benefits of higher systems thru-put by shrinking the "dead-time" between lifting/lowering of loads. The IMPULSE•G+ adjustable frequency drive has output frequency capability above 60 Hz. This capability beyond base speed (60 Hz) is utilized by the SWIFT LIFT Overspeed Operation function. The IMPULSE•G+ monitors its own output current (output current is proportional to load when the motor is running at a constant speed), and if the output current is below a programmable parameter, the drive will automatically accelerate to a higher frequency. Example: A given hoist is rated for 15FPM. Under certain conditions of "no load", the rated speed of the hoist can be increased to 30FPM (or any other speed below 200%).

Note: Please consider all the mechanical components' rotating speed before enabling SWIFT LIFT Overspeed Operation. Permission from the component manufacturer is required for successful SWIFT LIFT operation.

9.10.2 Programming Method:

SWIFT LIFT function is enabled by Sn-08, digit 4 = data "1"

Cn-45 = SWIFT LIFT Enable Current at Forward

- If current during Forward operation \leq Cn-45, then SWIFT • LIFT™ enabling procedure continues.

Cn-46 = SWIFT LIFT Enable Current at Reverse

- If current during Reverse operation \leq Cn-46, then SWIFT • LIFT™ enabling procedure continues.

Cn-47 = SWIFT LIFT Maximum Frequency

- After enabling procedure is completed, actual Frequency output is determined by the formula: $F\text{-Out} = \text{Speed Ref.} \cdot (Cn-47/Cn-02)$

Cn-48 = SWIFT LIFT Acceleration/ Deceleration Time Gain

- After enabling procedure is completed, the actual acceleration/ deceleration time is determined by the formula: $\text{Acc/Dec Time} = Bn-01(02)/Cn-48$

(Cont.)

9.10.2 Programming Method (Continued):

Cn-49 = SWIFT LIFT Threshold Frequency

- The beginning of the SWIFT LIFT enabling procedure--F-Out must be \geq Cn-49 to begin current detection (Cn-45(46) function).

Cn-50 = SWIFT LIFT Delay Timer

- The last function of the SWIFT LIFT enabling procedure--after reaching the Threshold Frequency (Cn-49), and detecting that current is \leq Cn-45(46), then the SWIFT LIFT Delay Timer is enabled. After "time out" of Cn-50 F-Out becomes per function of Cn-47

9.10.3 SWIFT LIFT Flow Chart

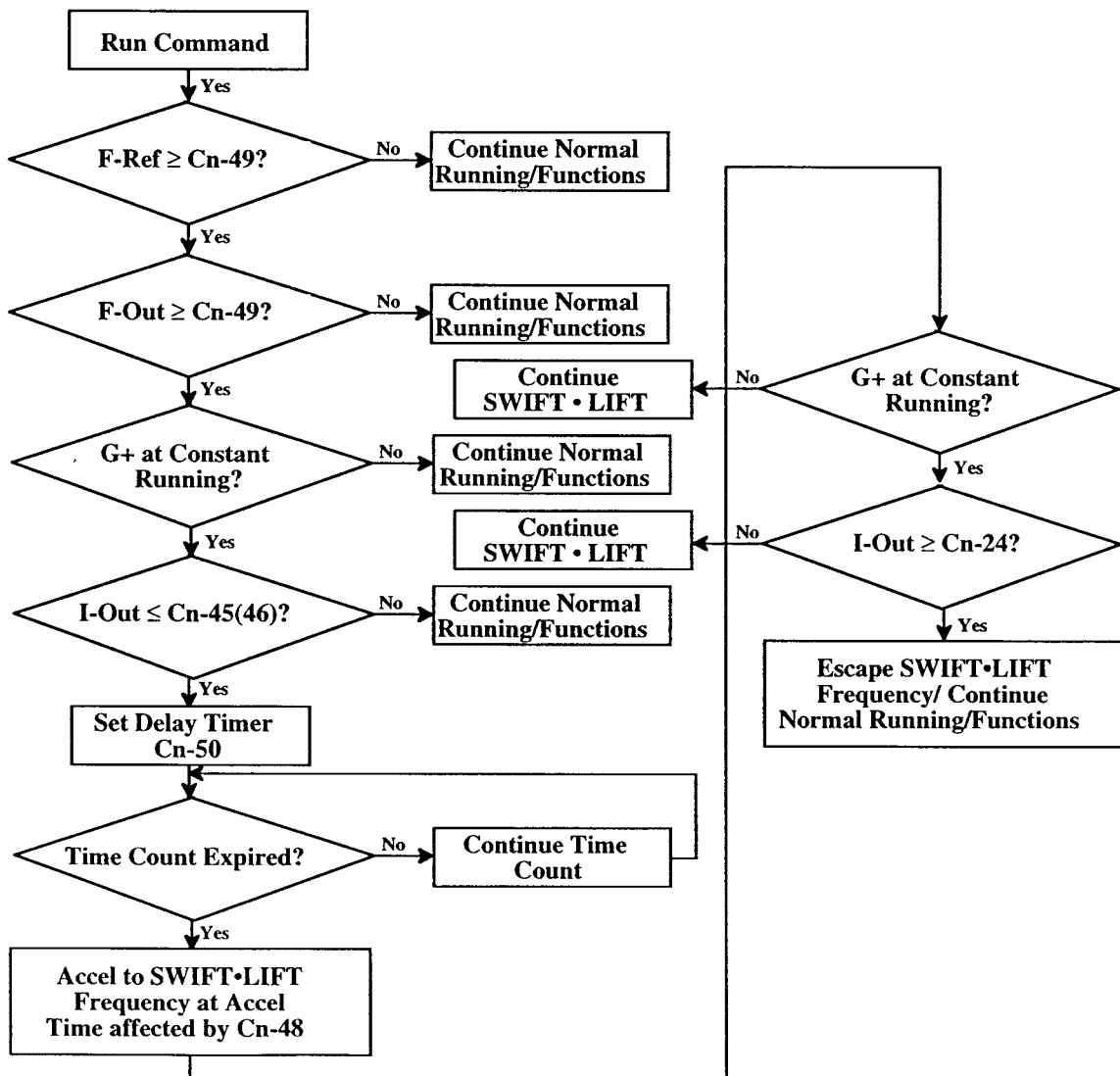

9.11 Phase Loss Detection

Phase Loss Detection compares the output current of each of the three phases to a pre-set level. If the output current of any of the phases falls below that pre-set level, an LF fault will appear on the display.

9.11.1 Programming Method

Cn-51 = Frequency level at which Phase Loss Detection is activated (set as a percentage of Cn-02).

Cn-52 = Current level at which a phase loss fault would be detected (set as a percentage of drive rated current). If current falls below this level, for a period > Cn-53, an LF fault occurs.

Cn-53 = Phase Loss Detection delay time (set in seconds). Setting Cn-53 = 0 disables the Phase Loss Detection function.

SECTION 10: PRECAUTIONARY CHECKS BEFORE TEST/RUN OPERATION

10.1 Checks Before Test Run/Operation

After mounting and interconnections are completed, please check for:

- * Correct connections
- * Correct Input Power Supply (No voltage drop or imbalance, Source KVA \leq 500 KVA)
Please note that 460V input to a 230V inverter will destroy the unit.
- * No Short circuit conditions
- * No loose screw terminals (Check especially for loose wire clippings)
- * Proper load conditions

Precautions:

- * Only start the motor if the shaft is stopped.
- * Even with small loading, never use a motor whose nameplate amperage exceeds the inverter rated current.
- * When starting and stopping the motor, be sure to use the operation signals (Fwd/Rev), not the magnetic contactor on the power side.
- * **Special Extreme Caution:**
Braking Method selection as shipped from Electromotive Systems, Inc. factory is set for "Immediate Stop" upon receiving a STOP command (i.e. motor brake sets). If changed to "Decelerate" at STOP command, then extreme caution should be used as regards to Deceleration time as set in constant Bn-02. If Deceleration time is too long, equipment may run into end-stop device causing damage to equipment or injury to personnel.

SECTION 11: MAINTENANCE

11.1 Maintenance

IMPULSE•G+ requires almost no routine checks. It will function efficiently and longer if it is kept clean, cool and dry, observing precautions listed in Section 2.1. Especially check for tightness of electrical connections, dis-coloration or other signs of overheating. During servicing inspection, turn off AC main circuit power and wait at least ten (10) minutes before touching any circuit components. The red "CHARGE" lamp must be extinguished before touching any components. Failure to adhere to this warning could result in serious injury.

SECTION 12: TROUBLESHOOTING

Of all the sections contained within this manual, this section is obviously one that all users wish to avoid, yet what follows is clearly the most important information within this manual. Because equipment downtime is in most situations not tolerable, diagnosing, troubleshooting and correcting problems becomes the most critical aspect of applying adjustable frequency technology to overhead material handling equipment.

Section 12 is designed to simplify the task of troubleshooting by presenting logical procedures and step by step advice on how to get the equipment up and running in the most expeditious manner. **REMEMBER!** efficient troubleshooting means following a logical sequence. The following sub-sections describe this logical sequence.

12.1 Troubleshooting 101 - Where to Begin.

The first and most logical step is to clearly **identify all the symptoms**. To simplify matters, we can divide all symptoms into two basic groups:

1. Symptom #1: Equipment will not operate.
2. Symptom #2: Equipment operates, but operation is either intermittent or not acceptable (i.e. motor does not accelerate, only one direction is achieved, motor stops running quite frequently).

In addition to identifying the symptoms, it is important that you follow this additional basic advice for efficient troubleshooting:

1. Gather all pertinent information relating to the problem.
2. Eliminate possible causes.
3. Document everything.

12.1.1 Troubleshooting for Symptom #1 - Equipment Will Not Operate.

Following these steps will greatly reduce the time it takes to determine a solution to the problem.

STEP 1: Check for visible signs of damage to **IMPULSE•G+** or related components. If found, **DO NOT** operate the drive. In addition:

- A. Measure and record incoming line-to-line supply voltage (L1, L2, L3).
- B. Call Electromotive Systems.

STEP 2: If there are no signs of visible damage, apply power and verify that the "CHARGE" lamp (always located just left of the main power terminal strip) is lit.

- A. If not, call Electromotive Systems.

12.1.1 Troubleshooting for Symptom #1 - Equipment Will Not Operate (Continued)

STEP 3: With power on, identify the keypad display:

- A. Is keypad blank? If yes:
 - 1. Measure and record incoming line-to-line supply voltage (L1, L2, L3).
 - 2. Call Electromotive Systems.
- B. Is a Fault Code displayed as found in Section 12.3 of this manual?
 - 1. Record Fault Code.
 - 2. Refer to Section 12.2 for possible solutions to common fault conditions.
 - 3. If fault code is listed, take appropriate action as prescribed in Section 12.2.
 - 4. If fault code is not listed in Section 12.2, call Electromotive Systems.
 - 5. Ensure that the FAULT HOLD/FAULT RESET switch found on TC-GIF-5 (or TC-GIF-4) interface card (circuit board which is attached to the terminal strip of the drive) is in the FAULT RESET position.
 - 5. Attempt to run motor.
 - 6. If operation fails, measure and record line voltage and call Electromotive Systems.
- C. Is **IMPULSE•G+** in the DRIVE mode (or mistakenly in the programming mode)?
 - 1. Ensure that the DRIVE lamp on the upper left hand corner of the keypad is lit.
 - 2. If not, depress [DRIVE/PROGRAM] key.
 - 3. Attempt to run motor.
- D. Is **IMPULSE•G+** set up for remote operation (i.e. from a pushbutton station, for example)?
 - 1. Ensure that the SEQ and REF lamps located on the upper right hand corner of the keypad are lit.
 - 2. If not, **IMPULSE•G+** may be set up for local operation. In this case, you must change constant #Sn-04, Digit 0 from data 1 to 0. **NOTE: Please refer to Section 5 of this manual if you have no prior experience in programming IMPULSE•G+. Or, call Electromotive Systems for assistance.**
 - 3. Attempt to run motor.
- E. Is the keypad display normal (i.e. 0.00 for monitoring output frequency)?
 - 1. If not, change the display mode by depressing the [DISPLAY] key until 0.00 appears.
 - 2. Proceed to STEP 4.

STEP 4: If STEPS 1-3 have not resulted in a solution to the problem, the following wiring checks should be made:

- A. Check all terminals of the **IMPULSE•G+** for loose connections or strayed wires. Be sure that the ground terminal is connected.
- B. Check all motor connections for loose wires, and check for proper motor lead connection to the inverter.
- C. Check for discontinuities in the control circuit wiring external to the drive. Especially check for:
 - 1. Continuity on all pushbutton (or radio, infra-red, joy-sticks, etc...) wiring.
 - 2. Motor klaxons open.
 - 3. Limit switches open.
 - 4. External thermal overload contact open.

12.1.1 Troubleshooting for Symptom #1 - Equipment Will Not Operate (Continued)

Ensure that **IMPULSE•G+** is connected in the prescribed manner, and that all connections, both power and control, are correct. Refer to Section 3 of this manual, or the appropriate wiring diagram accompanying **IMPULSE•G+** for more details.

STEP 5: If following STEPS 1-4 have not resulted in successful operation, call the Control Products Division Service Department at Electromotive Systems, Inc. immediately for further assistance. **DO NOT attempt to make any programming changes to IMPULSE•G+ unless you've had previous experience in the set-up and adjustment of the unit.**

12.1.2 Troubleshooting for Symptom #2 - Equipment Operates, But Operation is Either Intermittent Or Not Acceptable.

Following these steps will greatly reduce the time it takes to determine a solution to the problem.

STEP 1: Is there a fault condition?

- A. Ensure that the FAULT HOLD/FAULT RESET switch found on the TC-GIF-5 (or TC-GIF-4) interface card (circuit board which is attached to the terminal strip of the drive) is in the FAULT HOLD position.
- B. Run the equipment.
- C. When operation stops, observe the keypad display and record the Fault Code.
- D. Refer to Section 12.2 for possible solutions to common fault conditions.
- E. If fault code is listed, take appropriate action as prescribed in Section 12.2.
- F. If fault code is not listed in Section 12.2, call Electromotive Systems.
- G. Run the equipment.
- H. If intermittent operation continues:
 1. Record the Fault Code.
 2. Try to determine when the fault is occurring (i.e. at what point during operation does the equipment stop running).
 3. Measure and record incoming line-to-line supply voltage.
 4. Call Electromotive Systems.

STEP 2: Check All External Wiring.

- A. Refer to STEP 4 of Section 12.1.1 for details.

STEP 3: If following STEPS 1 and 2 have not resulted in successful operation, call the Control Products Division Service Department at Electromotive Systems, Inc. immediately for further assistance. **DO NOT attempt to make any programming changes to IMPULSE•G+ unless you've had previous experience in the set-up and adjustment of the unit.**

12.2 Possible Solutions to Common Fault Codes.

The following are common fault codes that may be displayed on the keypad for overhead material handling applications. **If the solution involves programming of the IMPULSE•G+, DO NOT attempt to solve the problem unless you are experienced in the set-up and adjustment of the unit.** If you are unsure about any of the solution methods, or the problem persists after corrective steps have been taken, consult the Control Products Division Service Department at Electromotive Systems, Inc. immediately for application assistance.

- | | |
|---------------------------------------|--|
| OC (Overcurrent) | <ol style="list-style-type: none">1. Check all external wiring and ensure that proper wiring precautions are being followed. Especially check for ground faults or short circuits at the output of the inverter.2. Check for proper Volts/Hertz relationship (Constant Sn-02 - See Section 8.3 for details).3. Lengthen acceleration time, if possible. (Constant Bn-01 - See Section 8.1 for details). |
| OV (Overvoltage) | <ol style="list-style-type: none">1. Check input supply voltage (L1,L2,L3). Is it within the specified rating?2. Check all external wiring and wiring precautions.3. Verify that the proper Dynamic Braking Resistance is applied. Call Electromotive Systems if it is not clear how to verify this or what resistor is required.4. Lengthen the deceleration time, if possible (constant Bn-02 or Bn-04, see Section 8.2 for details). |
| OL1 (Overload - Protect the motor) | <ol style="list-style-type: none">1. The motor overload protection function of IMPULSE•G+ is not programmed for the proper motor FLA's. (Refer to Section 8.4). |
| OL2 (Overload - Protect the inverter) | <ol style="list-style-type: none">1. Consult factory. IMPULSE•G+ (or the motor) may be undersized. |
| EF3 (or EF4) (External Fault) | <ol style="list-style-type: none">1. Check for erroneous control inputs at terminals 3 or 4 |
| PB (Pushbutton Sequence) | <ol style="list-style-type: none">1. Check that all speed inputs are being received in proper sequence (i.e., Fwd or Rev 1st speed, then 2nd speed, then 3rd speed, etc.). A PB fault could signal either an open control conductor or improper wiring of the control inputs. |
| FU | <ol style="list-style-type: none">1. Consult Electromotive Systems immediately. |
| CPFxx | <ol style="list-style-type: none">1. Consult Electromotive Systems immediately. Record the two digits following CPF. |

Consult Electromotive Systems immediately if the Fault Code being displayed on the keypad is not listed in this section.

12.3 General Description and Listing of all Possible Fault Codes

Display	Fault Contents	Description
Uu1	Undervoltage (PUV)	Undervoltage status occurs for more than 2 seconds
Uu2	Undervoltage (CUV)	Control circuit voltage becomes low during operation
Uu3	Undervoltage (MC-ANS fault)	Main circuit MC contactor does not operate properly
oC	Overcurrent	Inverter output current exceeds 200% of transistor rated current
oV	Overvoltage	DC bus voltage too high
Fu	Fuse Blown	Call Electromotive Systems Immediately
oH	Cooling fin overheat	Fin Temperature exceeds 90 deg. C (194 deg. F)
oL1	Motor overload	Protect the motor
oL2	Inverter overload	Protect the Inverter
oL3	Overtorque detection	Protect against overtorque conditons
oL4	Load check	Protect against lifting over-capacity loads
rr	Braking transistor fault	Call Electromotive Systems Immediately
EF3	External fault	External terminal 3 external fault
EF4	External fault	External terminal 4 external fault
Pb	Pushbutton sequence fault	Control input sequence is not correct
CPF00	Transmission error or control function hardware fault (including RAM and PROM)	Call Electromotive Systems Immediately
CPF01	Transmission error	Call Electromotive Systems Immediately
CPF02	BB circuit fault	Call Electromotive Systems Immediately
CPF03	NV-RAM (S-RAM) fault	Call Electromotive Systems Immediately
CPF04	NV-RAM (BCC, access code fault)	Call Electromotive Systems Immediately
CPF05	A/D converter fault in CPU	Call Electromotive Systems Immediately
CPF06	Option connection fault	Call Electromotive Systems Immediately
CPF20	Optional A/D converter fault	Call Electromotive Systems Immediately
LF	Phase Loss Detection	Phase Loss Detected

APPENDIX I: RECOMMENDED WIRING PRACTICES

**RECOMMENDED WIRING PRACTICES FOR APPLICATION OF
ADJUSTABLE FREQUENCY (AF) DRIVES ON
OVERHEAD MATERIAL HANDLING EQUIPMENT**

- 1) Use surge absorbers (R-C networks) on all relay and contactor coils.
- 2) Shielded cable shall be used for all low level D.C. speed reference signals (0-10VDC, 4-20 mA). Shield should be grounded only at the AF drive side.
- 3) Use a minimum of #16 AWG for control wiring, and #12 AWG (or larger) for power wiring. Size according to N.E.C. table 310-16.
- 4) The following is required for all dual motor bridge cranes and suggested for center driven cranes, trolleys and hoists. Upsize the wiring one size for every 25 feet of distance between AF drive and motor to account for voltage drop (which becomes significant at low frequencies).
- 5) Use time delay fuses for AF drive input protection. They shall be sized at approximately 150% of AF drive continuous rated ampacity.
- 6) Control and power wiring (including dynamic braking resistor wiring) shall be kept separate on terminal block strip.
- 7) Keep control (directional and speed command inputs to the AF drive) and power wiring from running together in parallel paths on the panel or in conduit runs. Keep control and power festoon wiring in different cables and separated.
- 8) If control and power wiring do meet on a panel, cross them perpendicularly.
- 9) Before applying power to the AF drive, check the output circuit (T1, T2, T3) for possible short circuits or ground faults.
- 10) Always mount the AF drive in its proper (vertical) orientation with at least 3" of clearance on all four sides. AF drives should be housed in appropriate NEMA rated enclosures for the environment in which they will be used.
- 11) Keep AF drive heatsink clear of any obstructions (components on panel) to ensure proper cooling air flow.
- 12) If using externally mounted interface boards, or remotely mounted speed reference signals, use shielded cable from the interface output or remote speed reference to the AF drive control input terminals.

Recommended Wiring Practices

- 13) On external input devices (control), hard contact inputs are preferred rather than solid state inputs into the control voltage input boards (TC-GIF__, TC-SIF__, TC-SLC__).
 - 14) If the input device is a PLC triac output, a 5K ohm, 10 watt resistor may have to be used between the signal and L2 (X2).
 - 15) AF drives should always have the cover mounted on unit during normal operating conditions to protect the digital operator (Specific to Electromotive Systems IMPULSE•G Series).
 - 16) All ground terminals or screws (“G” or “E”) must be grounded back to earth ground.
 - 17) If the power source is greater than 500 KVA, there should be at least 3% impedance in the line between the source and the input to the AF drive.
 - 18) Incoming power supply voltage must be limited to 230 volts \pm 10% or 460 volts \pm 10%.
 - 19) On existing wound rotor motor applications >25HP, a line reactor of 3% impedance shall be required on the load side of the AF drive. (Specific to Electromotive Systems IMPULSE•G Series.)
 - 20) When using more than one transformer for control power, properly phase each transformer with respect to other(s).
 - 21) All line and ground wiring should be disconnected when any welding is being done on or to the crane.
 - 22) When using the Impulse•S Series AF drive on existing wound rotor motor applications oversizing the drive or installing a load reactor is suggested to avoid over-current conditions upon starting a motor.
 - 23) When supplying single phase input to the AF drive, the ampacity of the drive must be derated by approximately one-half. (Consult Electromotive Systems.)
 - 24) All worm gear box hoist applications require dynamic braking resistors to avoid overvoltage conditions when lowering the hook.
 - 25) Sliding collector bars are not to be used between the drive and the motor. It must be hard wired (i.e. festoon cable).
- ** If there are any questions, or a further explanation of the above recommendations is needed, please contact Electromotive Systems at 414-783-3500 before proceeding.
- ** The above recommendations, if followed, will help to ensure trouble free start-up and successful operation of the adjustable frequency drive when applied to overhead material handling equipment.

APPENDIX II: RECOMMENDED MOTOR LEAD CABLE SIZING

**Wire Size in AWG for 460 Volts - 5% Max. Voltage Drop*

Wiring Distance Between Drive and Motor (in feet)	Full Load Motor Current (Amperes)											
	5	10	15	20	25	50	75	100	125	150	175	200
25	12	12	12	12	12	8	4	2	2	1/0	2/0	3/0
50	12	12	10	10	10	6	4	2	2	1/0	2/0	3/0
75	12	10	8	8	8	4	2	1/0	1/0	2/0	2/0	3/0
100	12	10	8	6	6	4	1/0	1/0	2/0	3/0	3/0	4/0
125	12	8	8	6	6	2	1/0	2/0	3/0	4/0	4/0	4/0
150	10	8	8	4	4	1/0	1/0	3/0	3/0	4/0	250M	350M
175	10	8	6	4	2	1/0	2/0	3/0	4/0	250M	350M	500M
200	10	6	6	4	2	1/0	3/0	4/0	250M	250M	350M	500M

The voltage drop in volts does not change significantly with frequency. For example, if the voltage drop at 60 Hz (460 Volts) is 2.0 Volts, then the voltage drop at 6 Hz (46 Volts) is also 2.0 Volts. Therefore, the motor lead cable must be sized so that the voltage drop at the lowest operating frequency does not exceed 5% of the drive output voltage at that frequency. i.e. @ 6 Hz, voltage is 46 Volts. Therefore:

$$\% \text{Voltage Drop} = \frac{2.0 \text{ Volts}}{46 \text{ Volts}} = 4.3\%$$

This table is applicable to all adjustable frequency drives, not only **IMPULSE** drives, due to the low voltages encountered at low frequencies.