

TELEMOTIVE SERIES 10KM12/24

RADIO

CONTROL

SYSTEM

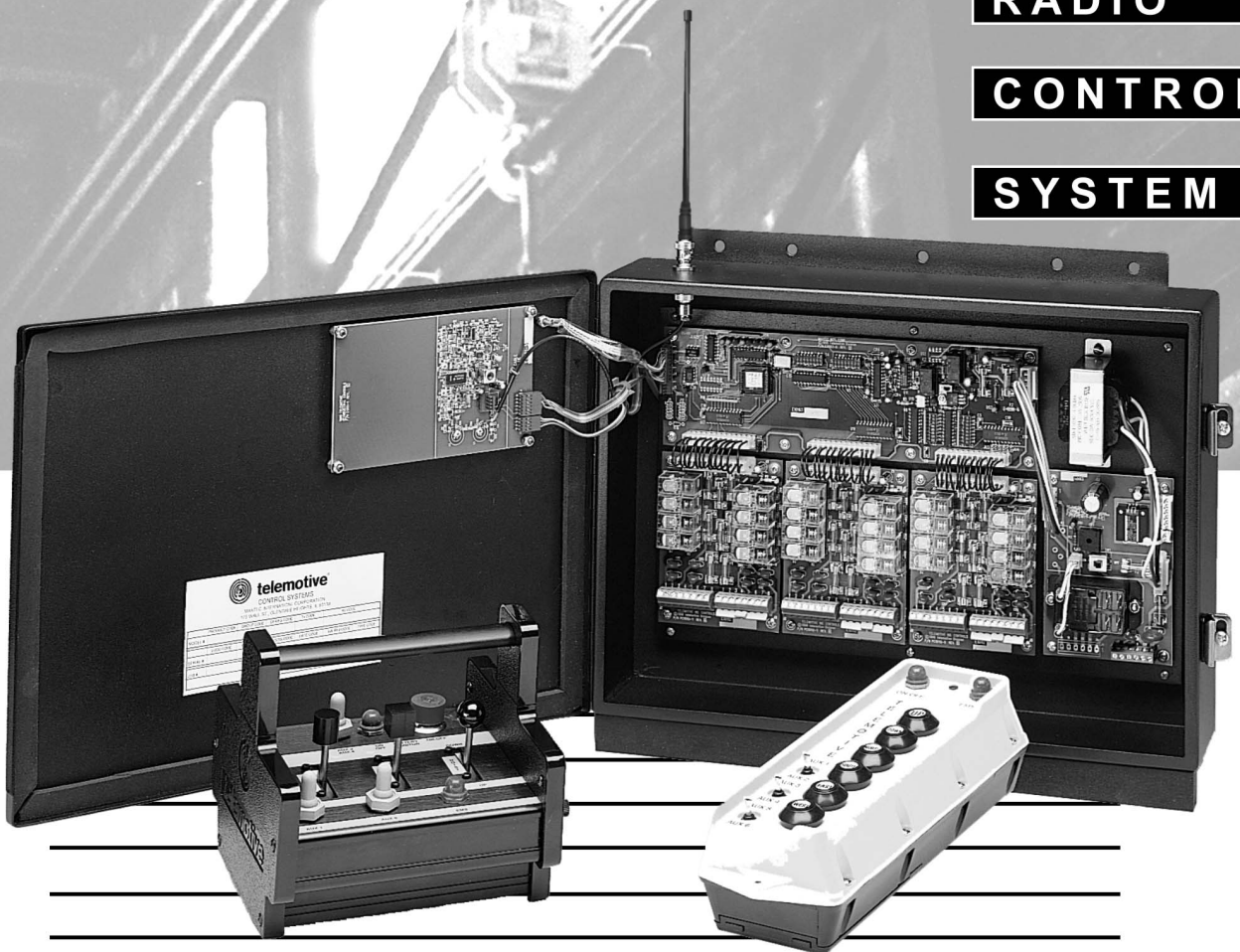

Telemotive Part Number TCK10MOD-0



MAGNETEK
UNCOMMON POWER

Phone: 800-288-8178
Fax: 800-298-3503

Material Handling Group

Table of Contents

Section 1 - Service Information Heading	1-1
1-1. Service Information	1-1
Section 2 - Radio Controlled Crane Safety	2-1
2-1. Introduction	2-1
2-2. General	2-1
2-3. Persons Authorized To Operate Radio Controlled Cranes.	2-1
2-4. Training Checklist For Crane Operators	2-1
2-5. Operating Area	2-1
2-6. Transmitter Unit	2-1
2-7. Operating The Crane	2-2
2-8. Boarding The Crane	2-3
2-9. Crane Repair.	2-3
2-10. Using The Crane As a Work Platform	2-3
2-11. Condition Of The Radio Controlled Crane	2-4
2-12. Battery Disposal	2-4
Section 3 - General System Information	3-1
3-1. General System Information	3-1
3-2. Transmitter Unit	3-1
3-3. Receiver Unit	3-1
3-4. System Specifications.	3-1
3-5. Time Multiplex Shared (TMS) System Software.	3-1
Section 4 - Installation Information.	4-1
4-1. Pre-Installation Considerations	4-1
4-2. Receiver Unit Mounting Location Considerations.	4-1
4-3. Line Input Considerations	4-1
4-4. EZ Setup.	4-1
4-5. Receiver Unit Cabinet Mounting	4-1
4-6. Receiver Installation.	4-1
4-7. Special Receiver Functions	4-2
4-7.1. Master Control Relay (MCR) Enable (S1)	4-2
4-7.2. Auxiliary Functions General	4-2
4-7.3. System Functions Selection	4-4
4-7.4. Auto Alarm and EMS Alarm	4-4
4-7.4.1. Auto Alarm (S2-1)	4-4
4-7.4.1.1. Description	4-4
4-7.4.1.2. To Enable.	4-4
4-7.4.2. Emergency Stop (EMS) Alarm (S2-2)	4-4
4-7.4.2.1. Description	4-4
4-7.4.2.2. To Enable.	4-4
4-7.5. Master Control Relay (MCR) Monitoring Disable (S2-3)	4-4
4-7.6. Auxiliary Function Relay Latching.	4-4
4-7.7. Time Out Timer Enable (S3-2)	4-4
4-7.8. Multibox Enable (S3-3).	4-4
Section 5 - Troubleshooting.	5-1
5-1. Diagnostic Led's	5-1
5-1.1. Microprocessor Control Module	5-1
5-1.2. Power Supply Module.	5-3
5-1.3. Relay and Output Modules	5-3
5-2. Output Module Testing.	5-3

Table of Contents (continued)

Section 6 - Programming and Servicing Information	6-1
6-1. 10KM Receiver CPU Board Programming and Servicing Information	6-1
6-1.1. S1 Switch Settings	6-1
6-1.2. S2 Switch Settings	6-1
6-1.3. JU2 Jumper Settings	6-1
6-1.4. S3 Switch Settings	6-1
6-1.5. S3 Multibox Setting	6-1
6-2. Pendant Transmitter Board Programming and Servicing Information	6-2
6-2.1. Setting Access Code	6-2
6-2.2. To Check Data	6-2
6-2.3. Battery Monitor Adjustment	6-2
6-3. Membrane Transmitter Board Programming and Servicing Information	6-3
6-3.1. Setting Access Code	6-3
6-3.2. To Check Data	6-3
6-3.3. Battery Monitor Adjustment	6-3
6-4. SLTX Transmitter Board Programming and Servicing Information	6-4
6-4.1. Setting Access Code	6-4
6-4.2. To Check Data	6-4
6-4.3. Battery Monitor Adjustment	6-4
6-5. Membrane Transmitter Mode Select	6-5
Section 7 - Spare Parts	7-1
7-1. 10K Receiver Spare Parts	7-1
7-2. 10K Pendant Transmitter Parts	7-2
7-3. Membrane Transmitter Unit Spare Parts	7-3
7-4. Small Lever Transmitter Unit Spare Parts	7-4
Section 8 - Transmitter Operation	8-1
8-1. Power On/Off Push-Button	8-1
8-2. E-Stop	8-1
8-3. Motion Push Buttons, Joysticks Or Levers	8-1
8-4. Transmitter LED Indicator	8-1
8-5. Time-Out-Timer	8-1
8-6. Key Switch	8-1
8-7. Servicing Information	8-1
Appendix A - 10K12/18 Pendant and SLTX Transmitter Programming	A-1
A-1. Transmitter Switches Sw3 and Sw4 Programming	A-2
A-1.1. Transmitter programming Sw3	A-2
A-1.1.1. Positions 1-3 (Pendant only) Switch Positioning	A-2
A-1.1.2. Positions 1-3 (SLTX only) no function	A-2
A-1.1.3. Positions 4-7 no function	A-2
A-1.1.4. Position 8 Time-out-timer Disable	A-2
A-1.2. Transmitter programming Sw4	A-2
A-1.2.1. Position 1-2 Mode Enable	A-2
A-1.2.2. Position 3 Disable Tandem for hoist and trolley	A-2
A-1.2.3. Position 4 Invert Crane Select Aux. Outputs	A-2
A-1.2.4. Positions 5-7 Extended Crane Control Configurations	A-2
A-1.2.5. Position 8 no function	A-2
A-2. Replacement Transmitter EPROM's	A-3
A-3. Multibox and Optional Output Board	A-3
A-4. Latching of Auxiliary Relays	A-3
A-5. Tables 1(a) through (k) Wiring and Programming Diagrams	A-4
A-6. Optional 120 Volt Wiring	A-4
A-7. Crane Control Type Selection	A-5

Table of Contents (continued)

Appendix B - 10K12 2-Speed Membrane Transmitter Programming	B-1
B-1. Transmitter Switches Sw3 and Sw4 Programming	B-2
B-1.1. Transmitter programming Sw3.	B-2
B-1.1.1. Positions 1-3 Switch Positioning	B-2
B-1.1.2. Position 4 Time-out-timer Disable	B-2
B-1.1.3. Positions 5-7 Extended Crane Control Configurations	B-2
B-1.1.4. Position 8 no function	B-2
B-1.2. Transmitter programming Sw4.	B-2
B-1.2.1. Positions 1-2 Mode Enable	B-2
B-2. Replacement Transmitter EPROM's	B-3
B-3. Multibox and Optional Output Board	B-3
B-4. Latching of Auxiliary Relays.	B-3
B-5. TABLE 1(a) through TABLE 1(g) Wiring and Programming Diagrams	B-3
B-6. Optional 110 Volt Wiring.	B-4
B-7. Crane Control Type Selection	B-5
Appendix C - 10K16/24 Pendant and SLTX Transmitter Programming.	C-1
C-1. Transmitter Switches Sw3 and Sw4 Programming	C-2
C-1.1. Transmitter programming Sw3.	C-2
C-1.1.1. Positions 1-3 (Pendant only) Switch Positioning	C-2
C-1.1.2. Positions 1-3 (SLTX only) no function	C-2
C-1.1.3. Positions 4-7 no function.	C-2
C-1.1.4. Position 8 Time-out-timer Disable	C-2
C-1.2. Transmitter programming Sw4.	C-2
C-1.2.1. Position 1-2 Mode Enable	C-2
C-1.2.2. Position 3 Disable Tandem for hoist and trolley	C-2
C-1.2.3. Position 4 Invert Crane Select Aux. Outputs.	C-2
C-1.2.4. Positions 5-7 Extended Crane Control Configurations	C-2
C-1.2.5. Position 8 no function	C-2
C-2. Replacement Transmitter EPROM's	C-3
C-3. Multibox and Optional Output Board	C-3
C-3.1. 10k16 Only	C-3
C-3.2. 10K24 Only	C-3
C-4. Latching of Auxiliary Relays.	C-3
C-5. TABLE 1(a) through TABLE 1(g) Wiring and Programming Diagrams	C-4
C-6. Optional 110 Volt Wiring.	C-4
C-7. Crane Control Type Selection	C-5

Table of Contents (continued)

This Page Intentionally Left Blank

Section 1 - Service Information Heading

1-1. Service Information.

For questions regarding service or technical information, contact the Telemotive Field Service Department.

For ordering replacement parts contact the Telemotive Order Entry Department.

Magnetek Material Handling Group
N49 W13650 Campbel Drive
Menomonee Falls, WI 53051

Phone: 800-288-8178

Website: www.telemotive.com

Fax Numbers:

Main: 800-298-3503

Sales: 262-783-3510

Service: 262-783-3508

Section 1 - Service Information (Continued)

This Page Intentionally Left Blank

Section 2 - Radio Controlled Crane Safety

2-1. Introduction.

The safety rules in this section are not intended to replace any rules or regulations or any applicable local, state, or federal governing organizations. The following information is intended to be used in conjunction with other rules or regulations already in existence. It is important to read all of the safety information contained in this section before operating the Radio Control System.

2-2. General.

Radio controlled overhead cranes and other material handling equipment operate in several directions. They are large, bulky pieces of equipment that handle heavy loads efficiently at high speeds. Quite frequently, the equipment is operated in areas where people are working on the floor below. Extreme caution must be exercised by the crane operator at all times. Workers must constantly be alert to avoid accidents. The following rules have been included to indicate how your careful and thoughtful actions may prevent injuries, damage to equipment, or even save a life. If radio controlled material handling equipment is operated from the cab, special care must be taken to secure the transmitter. Refer to paragraph titled "Boarding The Crane" for specific safety rules.

2-3. Persons Authorized To Operate Radio Controlled Cranes.

Only properly trained persons designated by management should be permitted to operate radio controlled cranes.

Radio controlled cranes should not be operated by any person who cannot read or understand signs, notices and operating instructions that pertain to the crane.

Radio controlled cranes should not be operated by any person with insufficient eyesight or hearing or by any person who may be suffering from a disorder or illness or is taking any medication that may cause loss of crane control.

2-4. Training Checklist For Crane Operators.

Anyone being trained to operate a radio controlled crane should possess the following knowledge and skills before operating the crane:

Knowledge of hazards peculiar to crane operation.

Knowledge of safety rules for radio controlled cranes.

Ability to judge distance or moving objects.

Knowledge of the radio transmitter.

Limit switch test procedure.

Where authorized, instructions for plugging motions.

Observing crane signal lights.

Avoid striking any obstructions.

Proper clearance of lifts or hooks before moving bridge or trolley.

Proper storage space for radio control box when not in use.

Transferring radio control box to another person.

Reporting unsafe or unusual operating conditions.

Caution in approaching bridge or trolley bumpers.

Equipment capacity.

Making lifts below floor level.

Making side pulls.

Keeping body clear of lifts and avoiding "pinch" points.

Cable and hook inspection.

Procedures for testing hoist, trolley, and bridge brakes.

2-5. Operating Area.

Aisles between equipment, stock, etc., should be free of obstructions so the crane operator can move freely. These aisles should be a minimum of 3 feet wide, or meet local regulations.

Crane operators should always position themselves for the best view of the crane they are controlling. The crane should never be operated blindly. The operator should stay as close to the crane load as possible. Operators should never position themselves in a "pinch" point.

2-6. Transmitter Unit.

Transmitter switches should never be mechanically blocked ON or OFF for any crane motion. When not in use turn the transmitter OFF. A secure storage space should be provided for the transmitter unit and the transmitter unit should always be placed there when not in use. This precaution will prevent unauthorized people from operating the crane.

Section 2 - Radio Controlled Crane Safety (Continued)

2-7. Operating The Crane.

The crane limit switches should be checked at the beginning of each shift or when a new operator takes control of the crane. When checking limit switches the hoist should be centered over an area free of personnel and equipment.

The limit switches should never be used as a regular stopping device. They are intended to be protective devices.

The bridge and trolley brakes should be tested at the beginning of each shift or when a new operator takes control of the crane. On transmitter units equipped with two speeds, use the "low" speed when testing braking devices.

When lifting maximum loads, the crane operator should test the hoist brakes by raising the load a few inches from the floor. If the brakes do not hold, the load should immediately be lowered to the floor and a report made to the supervisor.

Do not make lifts in excess of the equipment rated capacity.

The bridge and trolley should be centered directly over the load when the load is raised to prevent swinging when making lifts.

Side pulls should be made by a crane designed for this purpose and only with supervisor permission. When a lift is being made, the crane operator should not be positioned in the line of travel. The crane or hoist should be operated from a position either to the side or opposite from the direction of travel.

When raising or lowering a load, proceed slowly and make certain the load is under control. Tag lines should be used for handling unusual lengths or bulky loads. Remove slack from chains or slings gradually. Make certain all personnel are clear before making a lift.

The crane operator should keep all body parts away from the lift and should never be positioned under the lift.

Do not make a lift or move a load if anyone is in a location where they could be struck by the crane or the load.

If the crane operator is being helped, the crane should not be moved until the helper signals they are clear of the crane and its load.

When a load is hanging from the crane hook and the crane is being moved, the crane operator should sound all warning devices frequently.

Loads should not be carried over workers heads. If a worker is in the path of crane travel, the crane operator should stop the crane and clear the area before proceeding.

Runway stops or other cranes should never be bumped into.

When moving the crane, the crane operator should be sure that the hook block and attachments or cables will not catch on nearby equipment. Slings, chains, or cables should never be dragged along the floor.

Unless required for operator safety, gloves should not be worn when operating the transmitter unit.

All loose materials or parts should be removed from the load before starting the lift.

The crane operator should always hoist lifts high enough to clear all equipment and workers.

The crane operator should never permit anyone to ride on the load or hook except when authorized by the supervisor.

When another crane on the same runway is stationary with a load hanging, the crane operator should maintain a safe distance between the stationary crane and the one under their control.

If power to the crane is removed, the crane operator should turn the transmitter unit OFF and keep it OFF until power is restored.

If the crane fails to respond properly, the crane operator should stop operation, turn the transmitter unit OFF and immediately report the condition to their supervisor.

Outdoor cranes which are subject to movement by wind should be securely anchored when left unattended. If the crane is equipped with bridge brakes, the parking brake should be set immediately.

Section 2 - Radio Controlled Crane Safety (Continued)

2-8. Boarding The Crane.

The crane should not be boarded without permission of the supervisor.

The crane operator should turn off the transmitter and take it with them when boarding the crane.

If more than one person is boarding the crane, one person should be made responsible for ensuring all personnel are off the crane before the system is returned to operation.

2-9. Crane Repair.

Minor repairs include routine maintenance and repairs such as greasing, cleaning and control troubleshooting. All other repairs should be considered major. If the repair crew consists of more than one person, one person should be designated as the repair crew leader with the following responsibilities. If the repair crew consists of only one person, that person has the following responsibilities:

Warning signs should be placed on the floor beneath the crane or suspended from the crane. For major repairs, the floor area below the crane should be roped off.

When major repairs are to take place, all persons operating other cranes on the same or adjacent runways, if any, must be notified prior to starting repairs. Notification should include the nature of the repair, safeguards provided, and movement limitations while repairs are in progress.

When practical, radio controlled cranes which cannot be moved during repairs must be protected against being bumped by other cranes on the runway. Bumpers should be installed on the exposed side or sides of the crane under repair. They should be placed as far away as possible. The location of these bumpers should be indicated by red lights placed so that they are clearly visible to other crane operators traveling on the same runway. When it is not possible to use bumpers, red lights must be placed so they are clearly visible to other crane operators traveling on the same runway to indicate the restricted travel zone. All crane operators on the same runway must be informed of the repair effort and thoroughly instructed to what their operations are limited to and informed they will be notified when repairs are completed.

If any hazard involving the repairmen exists when there is a runway adjacent to the crane under repair, the adjacent runway should be blocked off as described above. When it is

necessary to continue crane operation on the adjacent runways warning lights must be installed and be visible to operators of cranes on those runways. All cranes should come to a complete stop prior to entering the restricted area and should proceed through this area only after receiving permission from a signal person designated for this purpose. Access of persons to and from the crane being repaired should be under control of the repair crew leader.

When boarding the crane, the transmitter should be turned OFF and the transmitter should remain with the repair crew leader. The leader should board the crane first, open and lock out the main switch, and then signal the other members of the crew it is safe to board the crane.

If work on the crane is to be done in areas not protected by standard handrails, approved safety belts should be worn by the repair crew.

All tools and equipment should be moved onto the crane by the use of hand lines. The tools and equipment should be adequately secured to the hand lines.

If it is necessary to have the crane control circuits energized, all power circuits for crane movement must be opened prior to energizing the control circuits.

All personnel and tools should be moved to a safe spot before moving the crane during repairs.

Head room is at a minimum in some crane cabs and on some crane walkways. Caution should be exercised when boarding or working on cranes. Hard hats should be worn whenever possible.

When repairs are finished, all personnel, tools and repair equipment should be removed before energizing the crane circuits.

2-10. Using The Crane As a Work Platform.

When the crane is to be used as a stationary work platform, follow all rules provided in "Crane Repair" section.

When it is necessary for the crane to be moved from time to time, the crane operator should board the crane with the transmitter unit. The crane operator should ensure all personnel working on the crane are in a secure position before moving the crane to the next work station. It should also be the crane operators responsibility to ensure the main switch is open and locked down before work is resumed.

Section 2 - Radio Controlled Crane Safety (Continued)

WARNING

THE CRANE OPERATOR SHOULD NOT ATTEMPT TO MAKE ANY OF THE REPAIRS STATED BELOW. THE CRANE CONDITION SHOULD BE REPORTED TO THE SUPERVISOR.

2-11. Condition Of The Radio Controlled Crane.

If the crane fails to respond properly, the crane operator should notify their supervisor. When serious conditions are noticed (conditions that make the crane unsafe to operate), the crane should be shut down immediately and the supervisor notified. The following is a list of what should be included in the report:

Condition of hoisting cable and hook block (broken strands, clipped sheave wheels, etc.).

Condition of brakes (hoist, trolley, and bridge).

Alignment of bridge (screeching or squealing wheels indicate bridge is out of line).

Broken, cracked, or chipped rails on trolley or runway.

Condition of limit switches.

Condition of electrical and mechanical control (electrical or mechanical defects which cause faulty operation such as uncommanded stopping or starting of any crane motions, warning devices, lights, or auxiliary functions).

Condition of gears (grinding or squealing may indicate foreign materials in gear teeth or a lack of lubrication).

Frequent relay tripping of power circuits.

Mechanical parts loosened by vibration (loose rivets, covers, bolts, etc.).

Uneven riding (worn wheels).

Condition of collector shoes or bars.

Condition of warning or signal lights (burned out or broken).

2-12. Battery Disposal.

Consult local requirements for disposal.

Section 3 - General System Information

3-1. General System Information.

The Series 10K Radio Control System (system) provides remote control of overhead cranes using radio signals. The system consists of a hand held portable battery operated transmitter unit and a fixed station receiver unit.

Each system has its own access code which permits a receiver unit to respond only to a transmitter unit with the same access code. Up to four transmitters may be used with the same frequency. Each transmitter operating on the same frequency may be operated in close proximity (not less than six feet) to each other.

Access Code: Any received signal which does not match the receiver access code is considered invalid by the receiver.

3-2. Transmitter Unit.

The transmitter unit is frequency modulated, low power and is certified under part 15 of FCC rules and regulations. A license is not required for the transmitter or operator. The transmitter unit uses crystal controlled oscillators to set the operating frequency.

A power down feature turns the transmitter unit OFF if no keys are pressed for an extended (approximately 15 minutes) period of time. The transmitter unit must again be turned ON. A configuration of the transmitter unit is available without automatic time-out.

Battery voltage and data transmission status is provided by an LED mounted on the front panel.

3-3. Receiver Unit.

The receiver unit consists of an RF receiver module, micro-computer control module, output relay/control modules and a power supply.

A power down feature turns the receiver unit OFF if no commands are received for an extended (approximately 15 minutes) period of time. A configuration of the receiver unit is available without automatic time out.

3-4. System Specifications.

Channel Designations:

AK1-439.8 MHz	AK6-438.8 MHz
AK2-439.6 MHz	AK7-438.6 MHz
AK3-439.4 MHz	AK8-438.4 MHz
AK4-439.2 MHz	AK9-438.2 MHz
AK5-439.0 MHz	AK10-438.0 MHz

AK11-437.8 MHz	AK16-436.8 MHz
AK12-437.6 MHz	AK17-436.6 MHz
AK13-437.4 MHz	AK18-436.4 MHz
AK14-437.2 MHz	AK19-436.2 MHz
AK15-437.0 MHz	AK20-436.0 MHz

Ambient Operating Conditions - -22°F to +158°F (-30°C to +70°C)

Humidity - up to 95% (non-condensing)

Typical Operating Range - 200 feet

Up to four transmitter units may operate on the same frequency while in close proximity (not less than six feet) to each other.

3-5. Time Multiplex Shared (TMS) System Software.

The system software is structured to minimize "on the air" transmission time of any transmitter. This allows for multiple transmitters to share a common frequency. The TMS system is designed so that a transmitter will send a signal for a predetermined ON time, and then will turn OFF. The length of transmitter ON time is referred to as data burst or packet. The packet length is a function of the quantity of data to be sent, and the data rate (baud). Once the packet is sent, the transmitter will turn OFF. This allows for other transmitters to time share the same frequency when a transmitter has turned OFF. The OFF period and repetition rate of the ON period are determined by the TMS system software. This allows up to 4 transmitters to share and have equal access to the same frequency, and also allows for reduced battery consumption and extended battery life.

Section 3 - General System Information (Continued)

This Page Intentionally Left Blank

Section 4 - Installation Information

4-1. Pre-Installation Considerations.

To ensure reliable and safe operation of the system, the following items must be considered before installing the receiver unit.

If the receiver unit is installed outdoors or in a corrosive environment, the receiver unit cabinet must be housed in a protective enclosure.

CAUTION

THE RECEIVER UNIT OR RELAYS ARE NOT RATED AS EXPLOSION PROOF. THE RECEIVER UNIT MUST NOT BE INSTALLED IN EXPLOSIVE ENVIRONMENTS UNLESS APPROPRIATE SECONDARY ENCLOSURE MEASURES ARE TAKEN.

The receiver unit should not be subjected to moisture.

4-2. Receiver Unit Mounting Location Considerations (See [Figure 4-2](#)).

The receiver unit requires a mounting area of approximately 14" wide by 18" long. A depth of at least 18" must be provided to allow the cabinet door to open.

Ensure the mounting location is as far as possible from exposed trolley wires and sources of electromagnetic or radiated noise.

If possible, avoid installing receiver unit to a surface where high vibration or shock is present. If this can not be avoided, use appropriate shock mounts.

4-3. Line Input Considerations.

WARNING

THE UNIT MUST BE WIRED TO THE CORRECT VOLTAGE, FAILURE TO DO SO MAY DAMAGE THE SYSTEM.

The receiver unit has direct and separate connect provisions for operation from 120 or 240 VAC (nominal), 50-60 Hz power.

For applications where line voltage deviation exceeds 20% of nominal values or if 440 VAC power is used, a step up or step down transformer must be used.

NOTE

The receiver unit should not be connected to lines containing excessive power up transients or continuous commutator noise. A line conditioner may be necessary in some installations.

4-4. EZ Setup

1. Determine the type of transmitter you have with your unit. SLTX, membrane or pendant as shown in [Figure 4-1](#). (For custom or special transmitter refer to custom documentation).
2. Refer to [Appendix A](#), [Appendix B](#), or [Appendix C](#) and select the wiring configuration that matches your application.
3. Refer to the transmitter switch programming table at the bottom of the page for the selected configuration.
4. If necessary, open the transmitter and set the switches as shown in the configuration diagram. Normally you unit is pre-programmed at the factory and only installation is necessary. The programming information for the transmitter and receiver is only needed for systems purchased un-programmed or to change system programming. Switch locations are in [Section 6](#). DO NOT CHANGE SWITCH SW1 OR SW2. These switches program the access code and must be programmed to match the receiver. After setting these switches reassemble the transmitter. Make sure fully charged batteries are placed in the unit.
5. Determine if you need to special program the receiver. NORMALLY YOU WILL NOT NEED TO CHANGE RECEIVER SWITCH SETTINGS. Change the receiver settings only to add latched functions, multi box or alarm settings. For information on these settings see [page 6-1](#).
6. Go to paragraph [4-5](#) Receiver Unit Cabinet Mounting.

4-5. Receiver Unit Cabinet Mounting.

Recommended mounting hardware is four - 1/4-20 hex machine screws of appropriate length, four 1/4-20 x 7/16 "keps" or elastic stop nuts.

Flat washers should be used in front of nuts when receiver unit is mounted to a non structural surface.

Mount receiver unit cabinet securely to mounting surface.

4-6. Receiver Installation (See [Figure 4-2](#)).

1. Mounting area, approximately 14" wide by 18" long.
2. Ensure mounting location is as far as possible from exposed Trolley wire and sources of electromagnetic or radiated noise. Antenna should be pointed straight up.
3. Mount unit and install antenna.
4. Set switch SW1 on power supply to off position towards right of cabinet. Set switch SW1 on computer module to the left to disable radio outputs.

Section 4 - Installation Information (Continued)

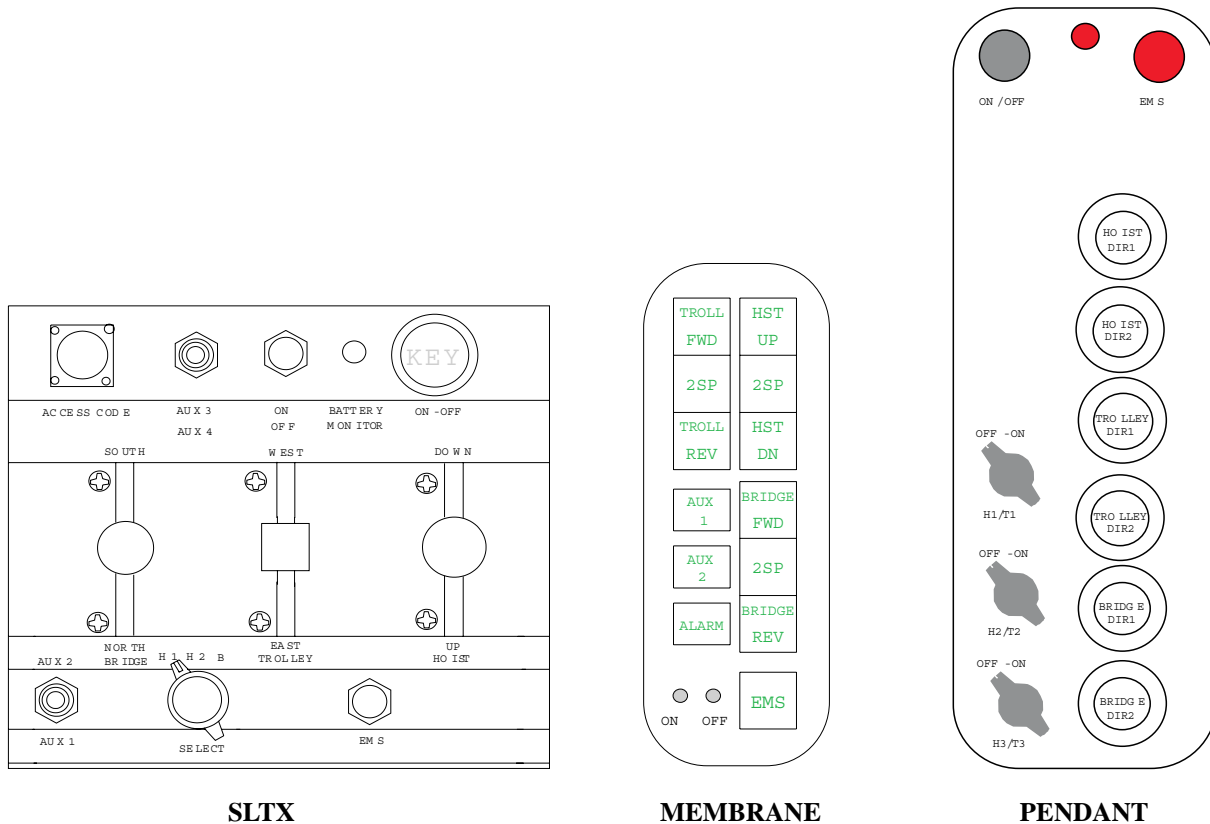

Figure 4-1. Transmitter Type

5. Connect power leads to right lower terminal strip J1 on power supply board to either 120 and ground or 240 and ground. See page 6-1.
6. Use [Appendix A](#), [Appendix B](#) or [Appendix C](#) and pick a diagram that fits the interface. All control wiring for the interface should be connected at terminals to J2 on relay output board. Note: J3 terminal block is prewired for single common control transformer. When using more than one control transformer the jumpers on J3 must be removed and J3 should be wired for the proper voltage per terminal.
7. In the lower right side of the receiver cabinet on the power supply board you will find relay K1 (MR). Terminals 2 and 4 are used to control any master relay function of the control. Relay K1 is shown in the wiring diagrams in [Appendix A](#), [Appendix B](#) and [Appendix C](#).
8. Wiring of the 10K system should now be complete.
9. Apply power.
10. Check out radio functions with the outputs disabled. Light DS3 should be out at this time. After the check, put S1 back to the on position DS3 should light. Check function and direction by jogging each motion. Installation should now be complete.

4-7. Special Receiver Functions.

4-7.1. Master Control Relay (MCR) Enable (S1)

This switch, when turned to off, disables the MCR and removes all output power to all output relays. This allows testing of the receiver control circuitry without activating any external functions such as motors and horns.

4-7.2. Auxiliary Functions General

The 10K receivers have auxiliary (Aux) function capability. These Aux functions are dedicated relays that can be used to sound horns, light lights or other functions. Typically a 10K12 has 3 Aux functions and a 10K16/24 has 4. However, there are a number of specialties and variations available. If your transmitter does not have a document describing these functions, the easiest way to determine what the Aux functions do is to look at the relay control boards and while depressing the appropriate Aux switch on the transmitter see which LED lights for which relay.

WARNING

MAKE SURE S1 MASTER CONTROL RELAY (MCR) IS TURNED OFF BEFORE ATTEMPTING THIS TO PREVENT ACTIVATION OF EXTERNAL CIRCUITRY. SEE PAGE 6-1.

Section 4 - Installation Information (Continued)

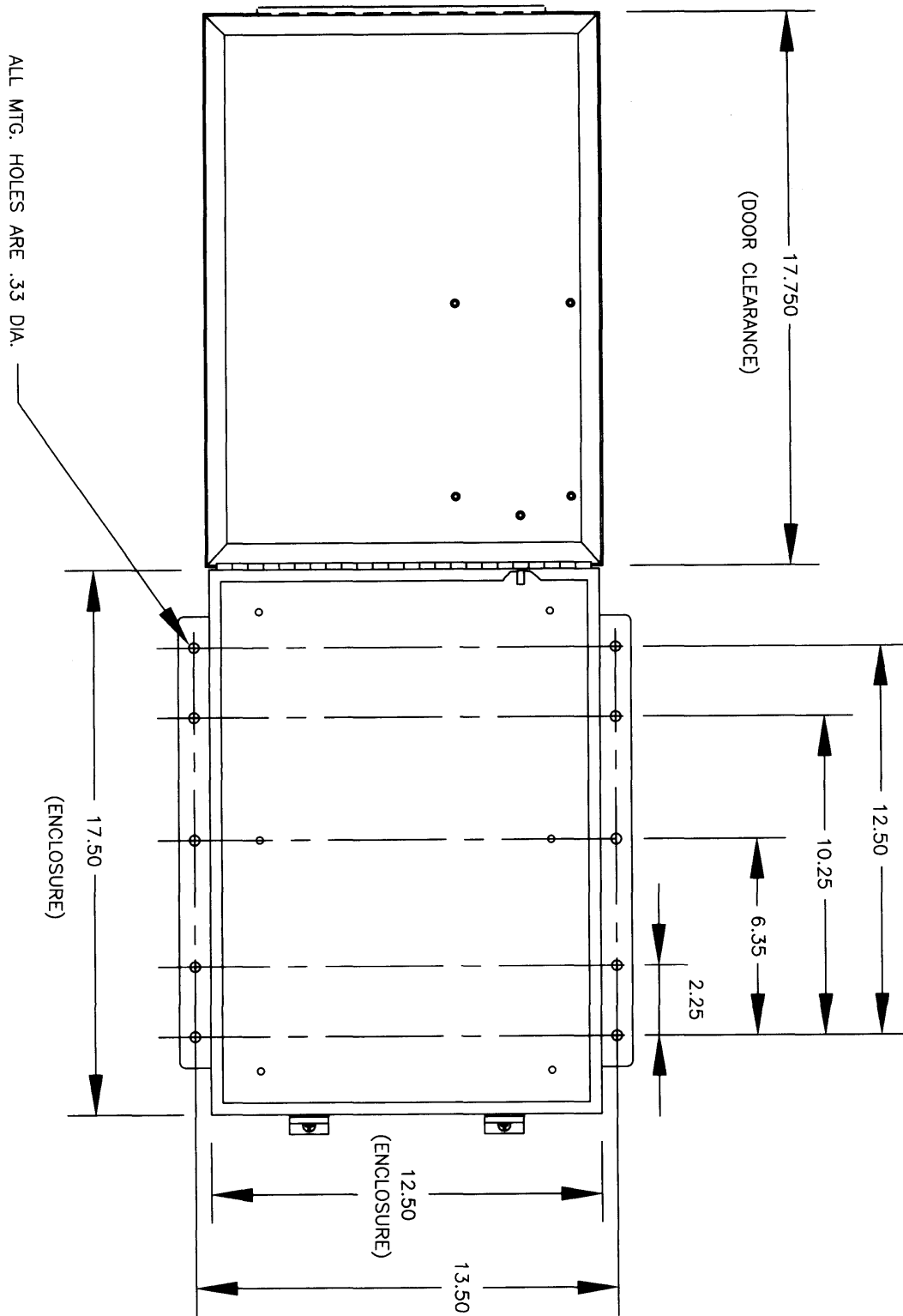

Figure 4-2. Receiver Mounting

Section 4 - Installation Information (Continued)

4-7.3. System Functions Selection

Special programming exists to allow some of the Aux relays to be dedicated for special system functions. Setting certain dip switches on the CPU Board enables this programming.

4-7.4. Auto Alarm and EMS Alarm

You can have either one of these functions or both. The use of either one of these two functions dedicates one specific control relay to operate an external alarm. An external alarm (not supplied) needs to be connected to this relay.

4-7.4.1. Auto Alarm (S2-1)

4-7.4.1.1. Description

Gives about 5 seconds of alarm when the transmitter is first turned on.

4-7.4.1.2. To Enable

Connect an external alarm. Move dip switch S2-1 on the CPU Board to the ON position. See page 6-1 for switch details and for location of the Alarm Relay. See the appropriate wiring diagram in [Appendix A](#), [Appendix B](#) or [Appendix C](#).

4-7.4.2. Emergency Stop (EMS) Alarm (S2-2)

4-7.4.2.1. Description

Gives about 5 seconds of alarm when the Emergency Stop (EMS) is activated on the transmitter.

4-7.4.2.2. To Enable

Connect an external alarm. Move dip switch S2-2 on the CPU Board to the ON position and set jumper JU2 to the upper position. (As a safety measure during EMS shutdown all control lines to relays are disabled. Jumper JU2 facilitates bypassing the EMS shutdown to the Alarm Relay so it can be activated during an EMS shutdown.) See page 6-1 for switch and jumper details and for location of the Alarm Relay. See the appropriate wiring diagram in [Appendix A](#), [Appendix B](#) or [Appendix C](#).

4-7.5. Master Control Relay (MCR) Monitoring Disable (S2-3)

Disables the contact monitoring of the MCR. Used for special diagnostic purposes only. In normal operation switch S2-3 should be set to OFF. Set to ON to disable contact monitoring of MCR.

4-7.6. Auxiliary Function Relay Latching (S2-6, -7 and -8)

Enables the appropriate auxiliary function relay to operate in a latched mode, on or off, rather than as a momentary contact. Which function is latchable and which relay is latched depends on the particular transmitter used.

Switch S2, positions 6 through 8 on the CPU Board each enable a separate relay to be latched when turned on. If your transmitter does not have a document describing these functions, the easiest way to determine correlation of transmitter function, relay position and dip switch position, is to try various dip switch setting and see which relays are latched and which transmitter controls them. Make sure all three switch positions are off, turn S2-6, S2-7 and S2-8 on separately and note which relay is affected by the appropriate LED indication.

WARNING

MAKE SURE S1 MASTER CONTROL RELAY (MCR) IS TURNED OFF BEFORE ATTEMPTING THIS TO PREVENT ACTIVATION OF EXTERNAL CIRCUITRY.

4-7.7. Time Out Timer Enable (S3-2)

The receiver contains a time out timer. If a receiver once turned on by a transmitter does not receive a signal from a transmitter for a period of 15 minutes the receiver shuts down. Setting S3-2 to ON disables this function.

4-7.8. Multibox Enable (S3-3)

One transmitter can only control the 10K receiver with a specific access code at a time. However, Multibox capability allows the 10K receiver to automatically switch to a new transmitter when the current controlling transmitter has been turned off and a new transmitter turned on. Up to 4 different transmitters can control one receiver. To enable this function the receiver must be preprogrammed from the factory for Multibox; the appropriate Multibox dip switch enabled (S3-3) and the correct access codes must be programmed into the appropriate transmitters. (Note: access codes are factory programmed into the receiver and the access codes are sequential.). Switch S3-3, when turned on, enables Multibox. Turning off S3-3 in 10K receiver preprogrammed from the factory for Multibox disables this function. S3-3 has no function in a receiver that is not preprogrammed by the factory for Multibox. For specific programming information see page 6-1.

Section 5 - Troubleshooting

5-1. Diagnostic Led's.

Series 10K12/24M (see page 6-1)

5-1.1. Microprocessor Control Module

The function of each LED is described in [Table 5-1](#).

Table 5-1. Diagnostic LED Function

LED	COLOR	FUNCTION
DS1	Green	<p>Monitors the 12 VDC power to the Microprocessor Control Board.</p> <p>Normally ON.</p> <p>If 12 VDC power is present then LED is illuminated. LED is off if 12 VDC power is not present. Check power supply, fuses and if power is on to receiver.</p>
DS2	Green	<p>Monitors + 5 VDC regulated voltage.</p> <p>Normally ON.</p> <p>If 5 VDC power is present then LED is illuminated. LED is off if 5 VDC power is not present. Check connectors, the +5 VDC regulator, or for shorts on the board.</p>
DS3	Red	<p>Monitors closure of the Master Control Relay (MCR) relay (K1).</p> <p>LED will be illuminated when the MCR relay has been enabled by an ON command received from the Transmitter Unit. Led will extinguish, when an OFF command has been transmitted, an EMS condition is present, or SW1 is set to 0.</p> <p>The MCR controls the 12 VDC power to the Master Relay on the Power Supply Board.</p>
DS4	Yellow	<p>Monitors closure of the Security Relay output (K2).</p> <p>The LED will be illuminated when the Security Relay has been enabled by an ON command received from the Transmitter Unit. LED will extinguish when an OFF command is transmitted, or an EMS condition is present.</p> <p>The Security Relay controls the 12 VDC power to the MCR relay (K2) and the power to the coils of the control relays (K1 through K8) on the Relay Output Modules.</p>
DS5	Yellow	<p>Monitors the AC bias pump line for the Security Relay (K2).</p> <p>LED will flash only when the Receiver has been enabled by an ON command.</p> <p>The Security Relay is enabled by an AC signal generated by the slave microcomputer. The AC signal is capacitively isolated from the slave microcomputer to help prevent the Security Relay from being latched ON if the slave microcomputer fails. LED will not be illuminated when an OFF command has been sent or an EMS condition is present.</p>
DS6	Yellow	<p>Monitors AC bias pump line for the Master Control Relay (K1).</p> <p>LED will flash only when the Receiver Interface Control Module has been enabled by an ON command.</p> <p>The Master Control Relay (K1) is enabled by an AC signal generated by the slave microcomputer. The AC signal is capacitively isolated from the slave microcomputer to help prevent the MCR from being latched ON if the slave microcomputer fails. The LED will not be illuminated when an OFF command has been sent or is in an EMS mode.</p>
DS7	Yellow	<p>Monitors data synchronization. (Flashes when a properly formatted data signal is received from the transmitter).</p> <p>This LED will flash rapidly when data is transmitted. The LED can be used with DS9 to analyze incoming data. If DS9 is illuminated or flashing when DS7 also is flashing, another Transmitter Unit on the same frequency may be present. This is normal. As more Transmitter Units operated on the same frequency, LED will flash brighter and more often.</p>

Section 5 - Troubleshooting (Continued)

Table 5-1. Diagnostic LED Function (Continued)

LED	COLOR	FUNCTION
DS8	Yellow	Monitors continuity between receiver and CPU modules. Normally ON. Off indicates a malfunctioning receiver.
DS9	Red	Monitors received data errors. Normally OFF. A flashing LED during data transmission may indicate interference of the received data. If LED is illuminated continuously when data is transmitted and the system will not respond the Access Code of the Receiver and Transmitter Units may not match. If LED is illuminated when data is not transmitted, another Transmitter Unit may be present on the same frequency with a different Access Code. The presence of activity on this LED does not necessarily indicate a problem. It should be used with other indicators in analyzing system status.
DS10	Yellow	Monitors system activity. Normally FLASHING. If not flashing the microprocessor is dead.
DS11	Red	Monitors the ON command from the Transmitter. LED will flash when an ON command is being received from the Transmitter. While pushing the ON button on the Transmitter this should light.
DS12	Red	Monitors the OFF command from the Transmitter. LED will flash when an OFF command is being received from the Transmitter Unit. While pushing the OFF button on the Transmitter this should light.
DS13	Red	Monitors EMS condition. Normally OFF. LED will flash when an EMS command is transmitted and illuminate continuously when the EMS condition is in effect. An EMS condition may be created when an EMS command is transmitted or when a failure mode is detected by the slave microcomputer. If both DS11 and DS13 are illuminated, a contact monitoring error has been detected. If both DS9 and DS13 are illuminated, the incoming data on the ICC bus has been corrupted.
DS14	Yellow	Monitors the AC activity for the Security Relay (K1). Normally ON. If the system is ON and the light is not lit there is a serious microprocessor error.
DS15	Red	Monitors the watchdog timer. Normally OFF. The LED will illuminate momentarily when power is applied to or removed from the system. If the LED is continuously flashing or on, the computer is not working properly. If LED is illuminated constantly (no flashing), the +5 VDC is probably too low. This could be caused by shorts on the board or by a defective voltage regulator. If the LED flashes at a constant rate, the microcomputer chip or EPROM may be defective.
DS16		Not used.

Section 5 - Troubleshooting (Continued)

5-1.2. Power Supply Module

The function of each LED is described in [Table 5-2](#).

Table 5-2. Diagnostic LED Function

LED	COLOR	FUNCTION
DS1	Green	Monitors unregulated 12 VDC. Normally ON. Check fuse, wiring to unit and AC power to unit.
DS2	Green	Monitors regulated 12 VDC. Normally ON. DS2 off and DS1 on, check for shorts on regulated output or blown regulator. Disconnect power supply connector to computer control board, if DS2 light comes back on there is a short on one of the other boards.

5-1.3. Relay and Output Modules

The function of each LED is described in [Table 5-3](#).

Table 5-3. Diagnostic LED Function

LED	COLOR	FUNCTION
DS1-6 or DS1-8	Red	Monitors the power to the relay coil or switching device. Normally OFF unless command is sent to turn ON. The numbers of LEDs depend on the number of functions per board. LEDs are located next to the relay or switch they control. Ground is switched to the relay coil or switch to turn it on; this also turns on the light.
DS7 or DS9	Yellow	Monitors 12 VDC to the relay or output module. Normally ON. LED off indicates no power to the relay or output module.

5-2. Output Module Testing.

The output module may be tested with a transmitter without activating crane controls by setting SW 1 to off. This allows the system to be tested and analyzed without causing movement of the crane by removing power to the master relay.

Section 5 - Troubleshooting (Continued)

This Page Intentionally Left Blank

Section 6 - Programming and Servicing Information

6-1. 10KM Receiver CPU Board Programming and Servicing Information

The receiver CPU board is shown in . Refer to paragraphs 6-1.1 through 6-1.5 for switch and jumper settings.

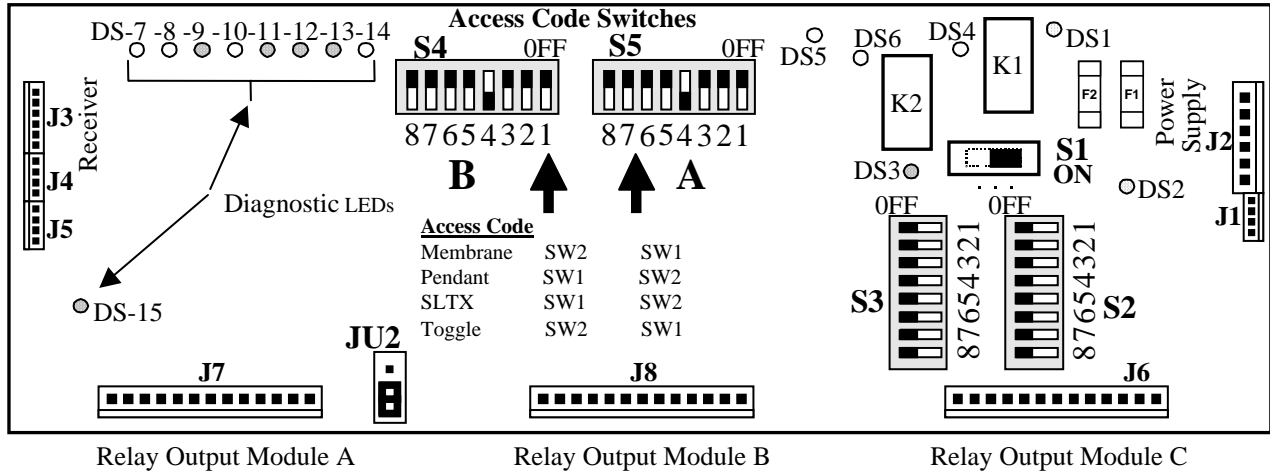

Figure 6-1 Receiver CPU Board Switch and Jumper Locations

6-1.1. S1 Switch Settings

Controls power to the Master Relay. With the switch set to ON power is on to all relays. Move the switch to OFF for circuit testing without activating external controls.

6-1.2. S2 Switch Settings

<u>S2-1</u>	Auto Alarm
OFF	Auto Alarm Disabled
ON	Auto Alarm Enabled
<u>S2-2</u>	EMS Alarm
OFF	EMS Alarm Disabled
ON	EMS Alarm Enabled
<u>S2-3</u>	Master Control Relay
OFF	MCR Disabled
ON	MCR Enabled
<u>S2-4</u>	Not used
<u>S2-5</u>	Not used
<u>S2-6, 7 & 8</u>	Aux Relay Latching*
OFF	Latching Disabled
ON	Latching Enabled

* See the specific configuration for your application for details on which switch controls which relay.

6-1.3. JU2 Jumper Settings

In the lower position (the position shown) the alarm relay is disabled after an E-Stop shutdown. This is the factory default setting. Moving it to the upper position enables it.

See the appropriate Programming Diagram for the Alarm Relay Location.

6-1.4. S3 Switch Settings

<u>S3-1</u>	Not used
<u>S3-2</u>	Time Out Timer
OFF	Time Out Enabled
ON	Time Out Disabled
<u>S3-3</u>	Multibox
OFF	Multibox Disabled
ON	Multibox Enabled
<u>S3-4 10K24 Only*</u>	
OFF	Aux Trolley
ON	Aux Hoist

* Only on the 10K24 with Multibox Enabled. First 4 relays on J6 are Multibox. Last 4 relays on J6 are either Aux Trolley or Aux Hoist.

S3-5 Not used

6-1.5. S3 Multibox Setting (Only with S3-3 On)

<u>S3-6</u>	<u>S3-7</u>	<u>S3-8</u>	<u>TXS</u>	<u>Access Code</u>
OFF	OFF	OFF	1	Base Address
OFF	OFF	ON	2	Base Address +1
OFF	ON	OFF	3	Base Address +2
OFF	ON	ON	4	Base Address +3

For more Base Address' please contact Telemotive.

Section 6 - Programming and Servicing Information (Continued)

6-2. Pendant Transmitter Board Programming and Servicing Information

The Pendant Transmitter boards are shown in Figure 6-2. Refer to paragraphs 6-2.1 through 6-2.3 for servicing procedures.

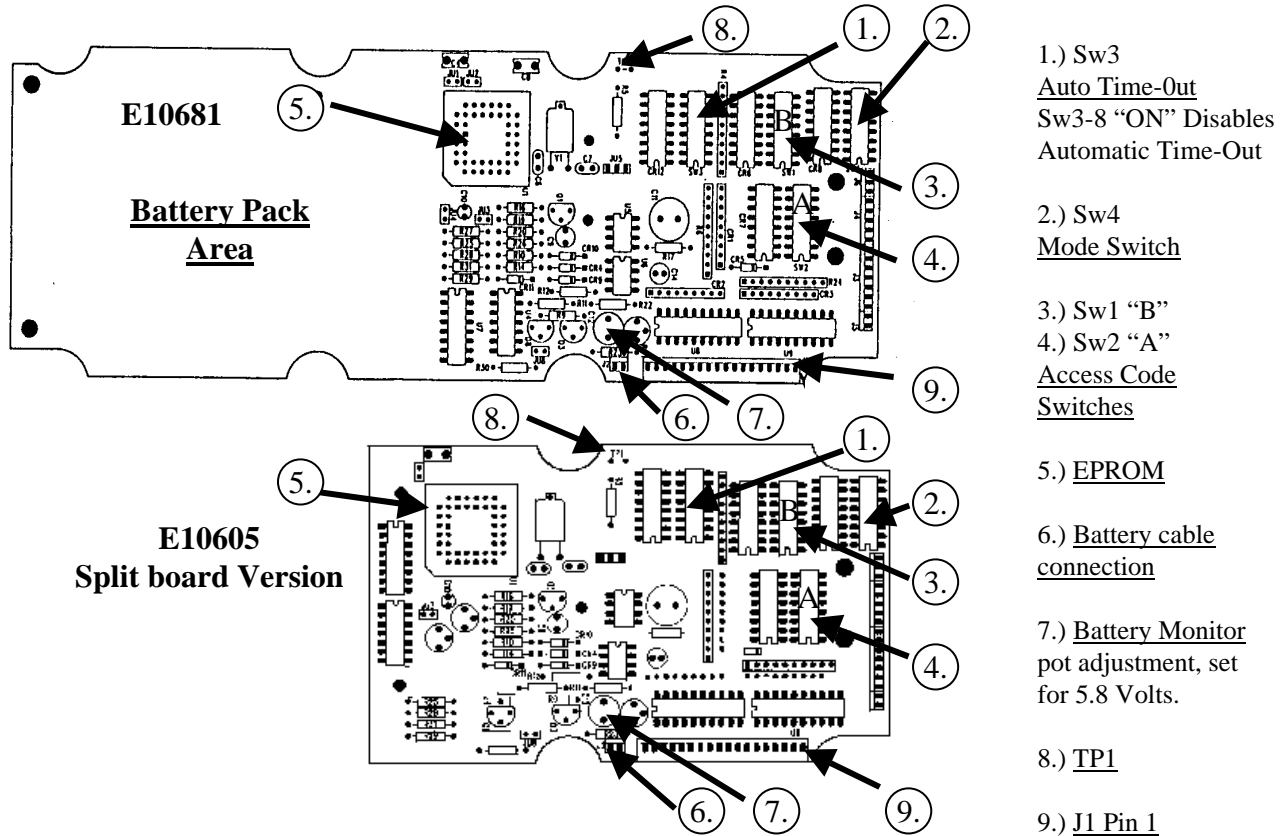

Figure 6-2. Pendant Transmitter Board

6-2.1. Setting Access Code:

The access code is set at the factory and should not be changed unless absolutely necessary. If a spare transmitter unit is used, the receiver unit access code should be changed to match the access code of the spare transmitter unit. Access codes are printed on a white label on the outside of any transmitter and maybe matched to S4 and S5 on the receiver microcomputer module without having to open the transmitter housing.

Switch SW1 (B) in the transmitter must match switch S4 (B) on the receiver microcomputer module and switch SW2 (A) in the transmitter must match switch S5 (A) on the microcomputer module.

6-2.2. To Check Data

- 1) For data input use Pin 1 of J1.
- 2) Use TP1 for External Trigger input.
- 3) Use Black Lead of Battery for Ground

6-2.3. Battery Monitor Adjustment

Connect power supply to battery leads observing polarity and set supply voltage to 5.8 volts. Adjust Battery Monitor pot to just turn off Red LED on the front of the transmitter.

Section 6 - Programming and Servicing Information (Continued)

6-3. Membrane Transmitter Board Programming and Servicing Information

The Membrane Transmitter board is shown in [Figure 6-3](#). Refer to paragraphs [6-3.1](#) through [6-3.3](#) for Servicing Procedures.

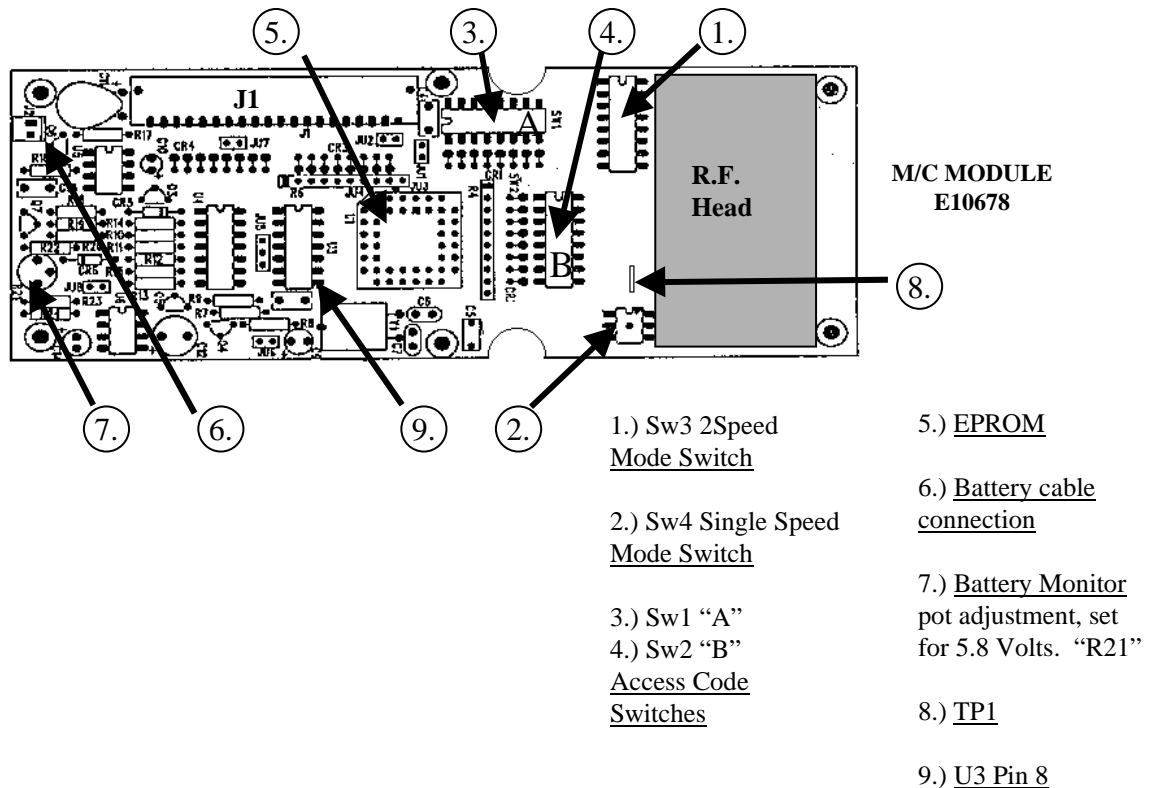

Figure 6-3. Membrane Transmitter M/C Module Board

6-3.1. Setting Access Code:

The access code is set at the factory and should not be changed unless absolutely necessary. If a spare transmitter unit is used, the receiver unit access code should be changed to match the access code of the spare transmitter unit. Access codes are printed on a white label on the outside of any transmitter and maybe matched to S4 and S5 on the receiver microcomputer module without having to open the transmitter housing.

Switch SW1 (A) in the transmitter must match switch S5 (A) on the receiver microcomputer module and switch SW2 (B) in the transmitter must match switch S4 (B) on the microcomputer module.

6-3.2. To Check Data

- 1) For data input use Pin 8 of U3.
- 2) Use TP1 for External Trigger input.
- 3) Use Black Lead of Battery for Ground

6-3.3. Battery Monitor Adjustment

Connect power supply to battery leads observing polarity and set supply voltage to 5.8 volts. Adjust Battery Monitor pot R21 to just turn off Red LED on the front of the transmitter.

Section 6 - Programming and Servicing Information (Continued)

6-4. SLTX Transmitter Board Programming and Servicing Information

The SLTX Transmitter board is shown in Figure 6-4. Refer to paragraphs 6-1.1 through 6-4.3 for servicing procedures.

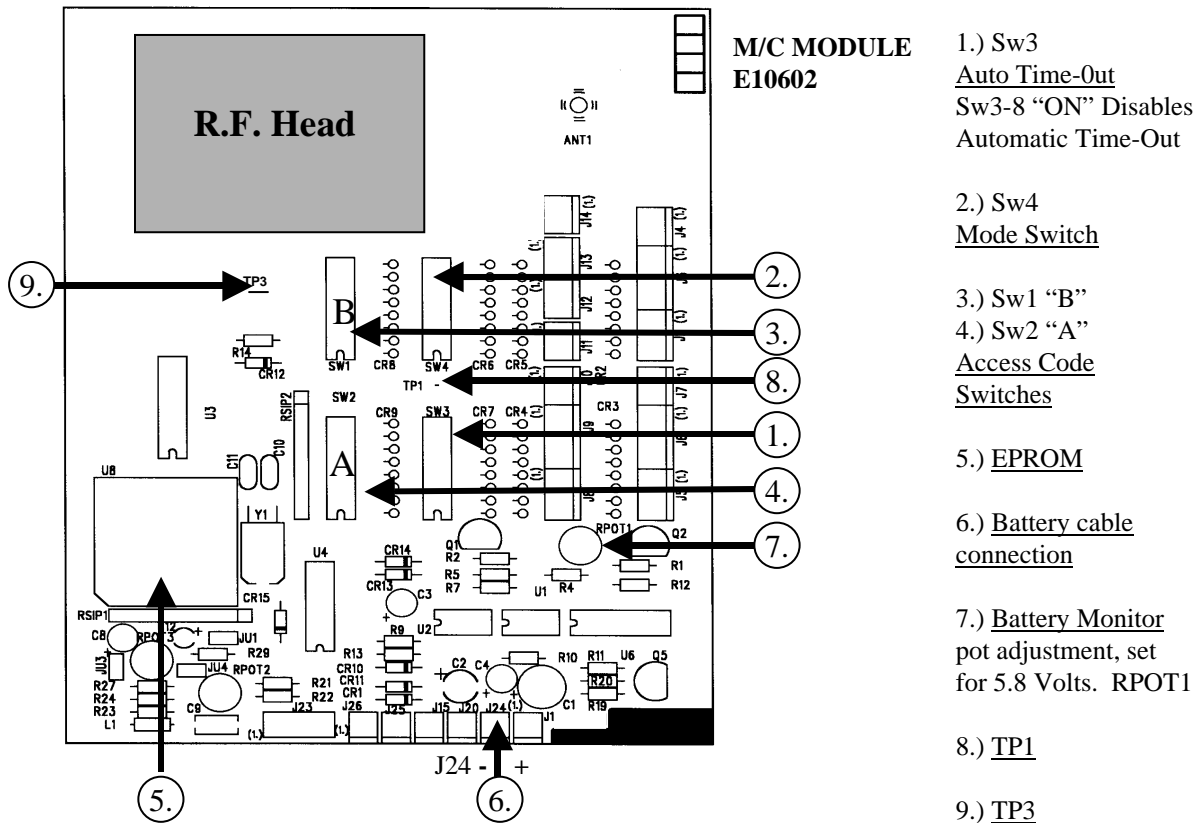

Figure 6-4. SLTX Transmitter Board

6-4.1. Setting Access Code:

The access code is set at the factory and should not be changed unless absolutely necessary. If a spare transmitter unit is used, the receiver unit access code should be changed to match the access code of the spare transmitter unit. Access codes are printed on a white label on the outside of any transmitter and maybe matched to S4 and S5 on the receiver microcomputer module without having to open the transmitter housing.

Switch SW1 (B) in the transmitter must match switch S4 (B) on the receiver microcomputer module and switch SW2 (A) in the transmitter must match switch S5 (A) on the microcomputer module.

6-4.2. To Check Data

- 1) For data input use TP3.
- 2) Use TP1 for External Trigger input.
- 3) Use Black Lead of Battery for Ground

6-4.3. Battery Monitor Adjustment

Connect power supply to battery leads observing polarity and set supply voltage to 5.8 volts. Adjust Battery Monitor pot RPOT1 to just turn off Red LED on the front of the transmitter.

Section 6 - Programming and Servicing Information (Continued)

6-5. Membrane Transmitter Mode Select

The Membrane Transmitter M/C module board is shown in [Figure 6-5](#). [Figure 6-6](#) provides switch settings for each operating mode.

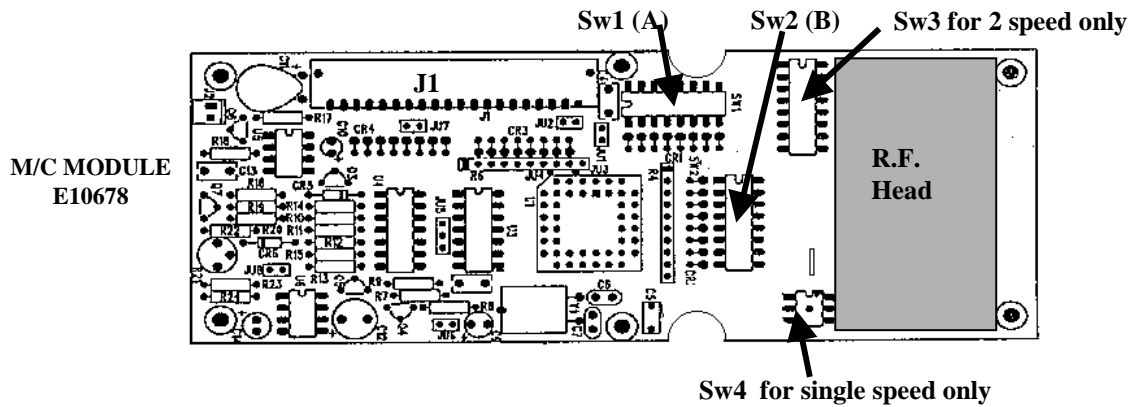

Figure 6-5. Membrane Transmitter M/C Module Board

NOTE: This section listed for reference only. This section details how to program the E10678 Membrane Transmitter Board for use in single speed transmitters. For all single speed modes (1 through 3) Sw3 must set to all "OFF".

Section 6 - Programming and Servicing Information (Continued)

NOTE: This section listed for reference only. This section details how to program the E10678 Membrane Transmitter Board for use in single speed transmitters. For all single speed modes (1 through 3) Sw3 must set to all "OFF".

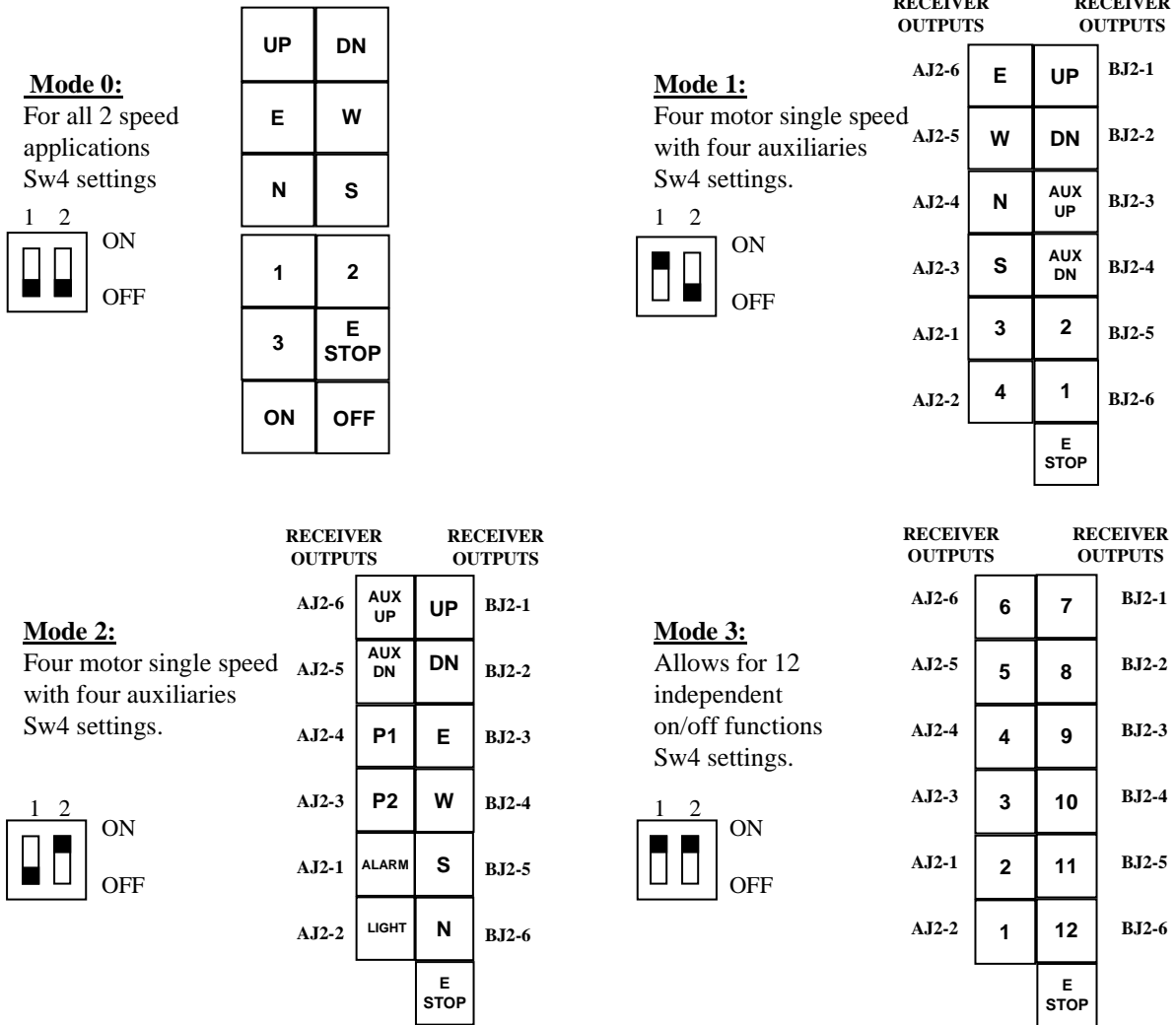

Figure 6-6. M/C Module Mode Switch Settings

Section 7 - Spare Parts

7-1. 10K Receiver Spare Parts

<u>PART</u> <u>NUMBER</u>	<u>DESCRIPTION</u>
E13151-5X	UHF RECEIVER MODULE
E10163-1	CPU EPROM (10K12 SINGLE BOX) System ROM FW2832-0
E10163-2	CPU EPROM (10K12 MULTI-BOX) System ROM FW2833-0
E10163-3	CPU EPROM (10K16/24 SINGLE BOX) System ROM FW2834-0
E10163-4	CPU EPROM (10K16/24 MULTI-BOX) System ROM FW2835-0
E10171-0	POWER SUPPLY MODULE
E10165-0	OUTPUT RELAY MODULE (6 RELAYS)
E10112-0	OUTPUT RELAY MODULE (8 RELAYS)
K2116-1	RELAY DPST-N.O. 25A, 12VDC COIL (POWER SUPPLY BOARD)
K1304-0	RELAY SPDT, 16A, 12VDC COIL (OUTPUT BOARD)
F2711-0	FUSE, 10A, 250V, 5X20mm SLO-BLO
F2711-1	FUSE, 1.0A, 250V, 5X20mm SLO-BLO
F2711-3	FUSE, 0.3A, 250V, 5X20mm SLO-BLO
W1098-2	JUMPER, INSULATED, 2-CIRCUITS
W1098-4	JUMPER, INSULATED, 4-CIRCUITS
AN100-0	ANTENNA
E2028-2	OPTIONAL REMOTE EXTERNAL ANTENNA KIT
	JUMPER WIRE 3 CIRCUITS

Section 7 - Spare Parts (Continued)

7-2. 10K Pendant Transmitter Parts

BLACK = 0

YELLOW = 1

PART

NUMBER

DESCRIPTION

E10668-X (NOTE 1)	CASE, TOP PENDANT, COMPLETE WITH SWITCHES, DECALS, BOOTS, ETC.
A10668-X (NOTE 1)	CASE, TOP PENDANT, WITH EYELETS
MP10668-X (NOTE 1)	CASE ONLY, TOP PENDANT
A1011 (NOTE 2)	BOOTS
H634-0	BOOT, GRAY
H635-0	BOOT, RED
H2055-3	LENS/MOUNT, LED W/SPACER, RED
S1039-2	SWITCH, PUSH BUTTON, 2-SPEED SBRU-SD
S1039-HK	SWITCH, PUSH BUTTON, 3-SPEED SBRU-TD
S1026-0	SWITCH, PUSH BUTTON, MOM N/O
S1040-0	SWITCH, ROTARY, SP3T
S1041-0	SWITCH, TOGGLE, SPDT, CTR OFF
MP10666-0	KNOB, ROTARY 1/2" DIA., BLACK
MP10675-0	BOOT, TOGGLE SW., BLACK
A10667-3	REPLACEMENT BOTTOM CASE W/GASKET AND BATTERY DOOR, YELLOW
A10667-2	REPLACEMENT BOTTOM CASE W/GASKET AND BATTERY DOOR, BLACK
MP10667-X	CASE ONLY, BOTTOM
A10667-X	BOTTOM CASE W/O BATTERY DOOR
A10669-X	BATTERY DOOR W/FOAM, W/O SCREWS AND LATCH
MP10676-0	FOAM, BATTERY DOOR
MP10677-0	GASKET FOR BOTTOM CASE
MP10650-X	LATCH FOR BATTERY DOOR
H251-0	SCREW FOR BATTERY DOOR LATCH
H252-0	WAVE WASHER FOR BATTERY DOOR LATCH
H2034-0	FLAT WASHER FOR BATTERY DOOR LATCH
H1047-0	COVER SCREWS
N10663-0	ACCESS CODE LABEL
N10666-0	FCC LABEL
A10670-0	BATTERY HOLDER ASSEMBLY, W/CABLE
H1049-0	SCREW, BATTERY BRACKET
MP10680-0	O'RING
MP10678-0	SHOULDER STRAP
BT10KP-0	BATTERY, ALKALINE
BT10KP-1	BATTERY, NICAD
E670-1	BATTERY CHARGER

NOTE 1

BLACK = 0 YELLOW = 1

NOTE 2

	<u>UP</u>	<u>DOWN</u>	<u>EAST</u>	<u>WEST</u>	<u>NORTH</u>	<u>SOUTH</u>
BLACK	3	4	11	12	9	10
YELLOW	23	24	31	32	29	30

Section 7 - Spare Parts (Continued)

7-3. Membrane Transmitter Unit Spare Parts

<u>PART</u> <u>NUMBER</u>	<u>DESCRIPTION</u>
A9654-0	STRAP ASSEMBLY
E9654-0	BATTERY HOLDER ASSEMBLY
A10662-1	TRANSMITTER CASE ASSEMBLY
A10663-1	BEZEL ASSEMBLY (SINGLE-SPEED TRANSMITTER)
A10663-2	BEZEL ASSEMBLY (TWO-SPEED TRANSMITTER)
A10664-1	BATTERY DOOR ASSEMBLY
S313-1	MEMBRANE SWITCH (SINGLE-SPEED TRANSMITTER)
S314-1	MEMBRANE SWITCH (TWO-SPEED TRANSMITTER)
S2803-0	MEMBRANE SWITCH (TACKLE)
MP9653-1	GREY PLASTIC KEY
A9657-1	INSERT PACKAGE (SINGLE -SPEED TRANSMITTER)
A9659-1	INSERT PACKAGE (TWO-SPEED TRANSMITTER)
MP9656-0	VINYL POUCH
A9665-0	RUBBER BOOT ASSEMBLY

Section 7 - Spare Parts (Continued)

7-4. Small Lever Transmitter Unit Spare Parts

<u>PART NUMBER</u>	<u>DESCRIPTION</u>
A231-204	ASSEMBLY, KEY SWITCH & CABLE, TX
A232-X	ASSEMBLY TOGGLE SWITCH & CABLE, TX
A234-2	ASSEMBLY, LED W/CONNECTOR
A235-0	ASSEMBLY, ROTARY SWITCH & CABLE, TX
A10685-1	ASSEMBLY BATTERY CONTACT BOARD
A2260-0	ENDCAP ASSEMBLY, BATTERY SIDE
A2261-X	ENDCAP ASSEMBLY, ANTENNA SIDE
E10601-X	10KSL:TX CPU MODULE
H633-0	BOOT, TOGGLE, RED
H634-0	BOOT, PUSHBUTTON, GREY
H635-0	BOOT, PUSHBUTTON, RED
H638-0	BOOT, TOGGLE, GREY
H2055-3	LENS, LED
MP135-1	KNOB/KEY ASSEMBLY, MOLDED
MP630-0	KNOB, CYLINDER 5/8 DIAMETER
MP632-0	KNOB, SQUARE 4/8 SQUARE
MP681-0	KNOB, SPHERICAL 3/4 DIAMETER
MP2161-X	TOP PANEL EXTRUSION 10KSLTX
N10170-X	LABEL TX FUNCTIONS, WRITE-IN
N10171-X	LABEL TX FUNCTIONS
S763-101	MOTION SWITCH 5-SPEED STEPPED
WA4645-0	RECEPTACLE, CODE PLUG
WA4647-X	CODE PLUG ENGRAVED WITH ACCESS CODE

Section 8 - Transmitter Operation

CAUTION

BEFORE OPERATING THE TRANSMITTER FAMILIARIZE YOURSELF WITH ALL SAFETY INFORMATION IN THIS MANUAL AND ANY OTHER LOCAL, STATE, OR FEDERAL RULES OR REGULATIONS ALREADY IN EXISTENCE.

8-1. Power On/Off Push-Button

Pressing the ON/OFF push-button switch turns on the transmitter. Pushing it again will turn the unit off.

8-2. E-Stop

When depressed all equipment movement is immediately stopped. The transmitter must be turned off and on again to restore normal operation.

8-3. Motion Push Buttons, Joysticks Or Levers

To active motor functions, press and hold the push-button that corresponds to the desired motion. To activate higher speed functions for those models so equipped press the motion switch a little farther.

8-4. Transmitter LED Indicator

The transmitter LED indicates on, transmitting and low battery voltage. A slow flash rate indicates the unit is on. A rapid flash rate indicates a unit is transmitting (when a button is depressed). If the battery goes below a safe level the LED will not light, replace battery immediately.

8-5. Time-Out-Timer

Unless disabled the transmitter will turn itself off if not used for 15 minutes.

8-6. Key Switch (For Models So Equipped)

For models so equipped, turning the key switch on enables power to the unit. The ON/OFF push button must still be pushed to turn the unit on. Under normal procedures it is recommended that the unit be turned off with the ON/OFF push button before turning of the key switch.

8-7. Servicing Information

CAUTION

FOR PRODUCT MODELS LISTED IN COMPLIANCE WITH UL, CSA AND ANSI INTRINSICALLY SAFE STANDARDS, DO NOT ATTEMPT TO REPAIR WITHOUT USING TELEMOTIVE APPROVED REPLACEMENT PARTS. FAILURE TO DO SO COULD VOID LISTING AND CREATE A SAFETY HAZARD. FOR INTRINSICALLY SAFE PRODUCTS ONLY QUALIFIED TRAINED SERVICE PERSONNEL ARE ALLOWED TO PERFORM REPAIRS. FAILURE TO USE APPROVED SERVICING TECHNIQUES AS WELL AS TELEMOTIVE APPROVED PARTS FOR INTRINSICALLY SAFE PRODUCTS COULD CREATE A SAFETY HAZARD. IF THERE IS ANY QUESTION AS TO WHOM IS QUALIFIED, WHAT PARTS TO USE OR PROPER SERVICE PROCEDURES PLEASE CONTACT YOUR TELEMOTIVE REPRESENTATIVE.

Section 8 - Transmitter Operation (Continued)

This Page Intentionally Left Blank

Appendix A - 10K12/18 Pendant and SLTX **Transmitter Programming**

NOTE: This section also contains information on Optional Output Board for Multibox and other optional outputs for the 10K18.

**Appendix A - 10K12/18 Pendant and SLTX
Transmitter Programming (Continued)**

A-1. Transmitter Switches Sw3 and Sw4 Programming. (See Sections 6-2 and 6-4 for physical location of transmitter switches).

A-1.1. Transmitter programming Sw3

A-1.1.1. Positions 1-3 (Pendant only) Switch Positioning. (Standard configuration all “OFF”).

The functional positions of the various buttons controlling the hoist trolley and bridge can be moved by transmitter dip switch Sw3 also. Positions Sw3-1 through Sw3-3 control these functions. No change in receiver wiring is needed to use these functions. See [TABLE 1\(m\)](#) for switch versus button configurations.

A-1.1.2. Positions 1-3 (SLTX only) no function. (Keep turned “OFF”).

A-1.1.3. Positions 4-7 no function. (Keep turned “OFF”).

A-1.1.4. Position 8 Time-out-timer Disable. (Normally keep turned “OFF”).

The transmitter has an approximate 15-minute time-out-timer. If the transmitter is not used for over 15 minutes it will shut down. This transmitter time-out-timer function is transmitter dip switch selectable. Sw3 position 8 disables the time-out-timer. Turning Sw3-8 “ON” disables the time-out-timer.

A-1.2. Transmitter programming Sw4

A-1.2.1. Position 1-2 Mode Enable. (Standard Mode 1 keep 1-2 turned “OFF”).

Mode 1, Sw4 1-2 all “OFF”. The 10K12 single speed system comes standard configured this way from the factory with three motion controls and six auxiliaries (controlled by the toggle switches). The 10K12 2-speed system comes standard configured this way from the factory with three 2-speed controls and three auxiliaries (controlled by the toggle switches, the rotary is non-functional).

Mode 2, Sw4 1 turned “OFF” and Sw4 2 turned “ON”. The 10K12 2-speed system configured this way is able to control four 2-speed motion controls and no auxiliaries this give bridge, trolley, main and aux hoist. The rotary selector switch functions are H1 main hoist, H2 aux hoist and B both main and aux hoist (the toggle switches are non-functional).

Mode 3, Sw4 1 and 2 turned “ON”. The 10K12 2-speed system will control up to 5 motors using the rotary selector switch. This mode reconfigures two of the 10K12 auxiliary outputs (Aux 1 and Aux 2) to be external motor select functions by the rotary switch. In this mode the auxiliary toggle switch Aux 1 and Aux 2 is disabled. When the rotary switch is in the H1 or H2 position Aux 1 relay or Aux 2 relay will pull in respectively when ever trolley or hoist pushbuttons are pressed. When the rotary switch is in B position both Aux 1 and Aux 2 relays will pull in.

A-1.2.2. Position 3 Disable Tandem for hoist and trolley. (Normally keep turned “OFF”).

For cranes with auxiliary hoists and/or trolleys, turning this switch “ON” disables the transmitter selector switch “B” position (both function) that selects tandem operation of hoist or trolley.

A-1.2.3. Position 4 Invert Crane Select Aux. Outputs. (Normally keep turned “OFF”).

For cranes that use the select function only, turning this switch “ON” inverts the select function operation so that the relay closes for the unselected function.

A-1.2.4. Positions 5-7 Extended Crane Control Configurations. (Standard all “OFF” otherwise see [TABLE 1\(c\)](#) through [TABLE 1\(l\)](#)).

The 10K12/18 2-speed Pendant and SLTX transmitter is available with extended crane control configurations. These options are switch configurable on the transmitter. The eight-position dip switches Sw3 and Sw4 on the transmitter can provide all configurations with a single transmitter CPU EPROM for the 2-speed transmitter. [TABLE 1](#) shows the available configurations and the switch programming needed to provide them. The standard transmitter comes with the output configuration is shown in [TABLE 1\(a\)](#) single speed and [TABLE 1\(b\)](#) 2-speed: TYPE 0 and has no extended crane control configurations. **For 2-speed extended crane control configurations:** See [TABLE 1\(c\)](#) through [TABLE 1\(l\)](#): TYPE 1 through CONFIGURATION 4 respectively. If a configuration listed in [TABLE 1\(b\)](#) through [TABLE 1\(l\)](#) is preferred over the standard configuration, please reprogram Sw3 and Sw4 respectively on the transmitter.

A-1.2.5. Position 8 no function. (Keep turned “OFF”).

Appendix A - 10K12/18 Pendant and SLTX Transmitter Rrogramming (Continued)

A-2. Replacement Transmitter EPROM's

All 10K12/18 Pendant (10K12 Pendant transmitters normally have a black top and a yellow bottom. 10K16/24 pendant transmitters normally have a yellow top and black bottom.) and SLTX transmitters use CPU EPROM part numbers as listed below:

Pendant 3/4/5 Motor	Single speed	10K12	FW2825-1
Pendant 3/4/5 Motor	Two speed	10K12	FW2826-1
Pendant 7 Motor	Two speed	10K12	FW2827-1
Pendant 3 Motor	Three speed	10K16/18	FW10K16P-1
SLTX 3/4/5 Motor	Two speed	10K12	FW2821-1
SLTX 3 Motor	Three speed	10K16/18	FW2819-0

A-3. Multibox and Optional Output Board:

WARNING

IF YOUR UNIT WAS NOT ORDERED WITH MULTIBOX DO NOT ATTEMPT TO PROGRAM MULTIBOX IN THE FIELD. TELEMOTIVE MUST COORDINATE ACCESS CODE ASSIGNMENTS WITH THE TRANSMITTERS PRIOR TO ENABLING MULTIBOX. PLEASE CONTACT TELEMOTIVE IF YOU NEED TO ADD MULTIBOX. FAILURE TO DO SO CAN BE A SERIOUS SAFETY HAZARD.

If Multibox is used (**Receiver** switch **Sw3-3** is "ON" and the Optional Output Board is installed in the receiver). The outputs are as follows:

C1-C2 Defined per type
C3 MULTIBOX 1
C4 MULTIBOX 2
C5 MULTIBOX 3
C6 MULTIBOX 4



A-4. Latching of Auxiliary Relays

Certain auxiliary relays can be set to latch (be toggled on and off) by setting dip switch S2 positions 6-8 on the **Receiver** CPU Board. If an Aux function is latchable it is noted in the programming diagram by the following note (LATCHABLE S2-#) where # is the switch position 6-8 that must be turned on for the latching function.

Appendix A - 10K12/18 Pendant and SLTX Transmitter Rrogramming (Continued)

A-5. Tables 1(a) through (k) Wiring and Programming Diagrams

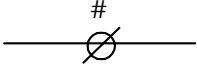
The following tables give various extended crane configurations. Functional terms like Trolley East and Hoist Up match standard transmitter labeling from the factory. The following legend is used in these diagrams:

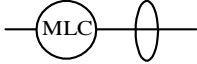
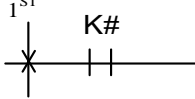
			
<p>Indicates terminal block J2 or J3 with terminal number # in the radio receiver output board</p>	<p>Indicates terminal block J1 in power supply board with the required connection noted.</p>	<p>Indicates customer supplied contactor coil with arc suppressor in parallel.</p>	<p>Indicates a relay contact in radio receiver number #. The X indicates the relay closing and the closing sequence (1st, 2nd, etc.) as the indicated switch is depressed.</p>

In the following wiring diagrams the relay outputs AJ2, BJ2 and CJ2 have listed to the right of the outer terminal, the appropriate motor function they control, i.e., trolley, hoist etc. Proper installation requires that this output be wired to a contactor controlling that function and that the contactor has the proper arc suppressor across it. The relays on these output boards are rated at 16 amps and fused at 10 amps unless otherwise noted.

A-6. Optional 120 Volt Wiring

Power supply wiring is accomplished through connector J1 on the power supply board. The connections labeled 240, 120, N and GND are wired to the appropriate supply connections per the wiring diagrams. An extra connection 120 is provided for 120 Volt applications only for jumpering to Pins 2 and 6 of the Master Relay (MR) K1 on the power supply board. The unit may optionally be wired as in [Figure A-1](#). [Figure A-2](#) shows the wiring layout. All other wiring is accomplished per the tables.

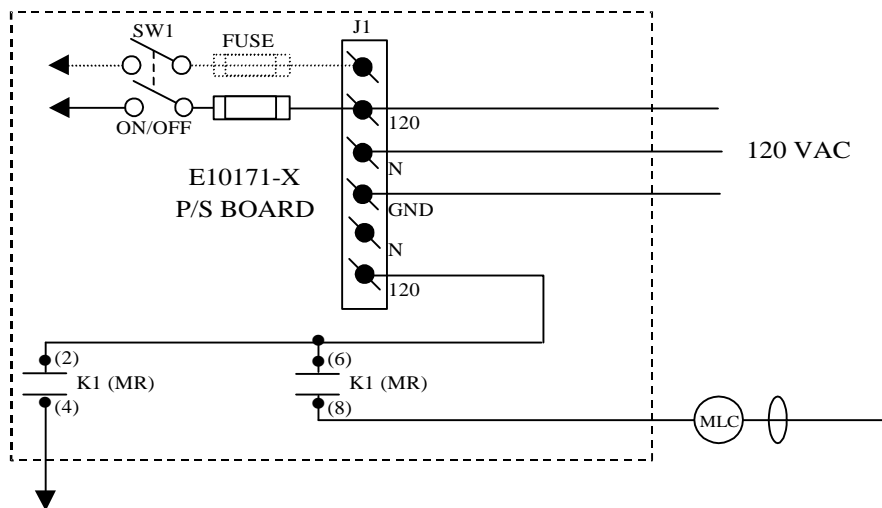

Figure A-1. Optional 120 VAC Wiring Diagram

**Appendix A - 10K12/18 Pendant and SLTX
Transmitter Rrogramming (Continued)**

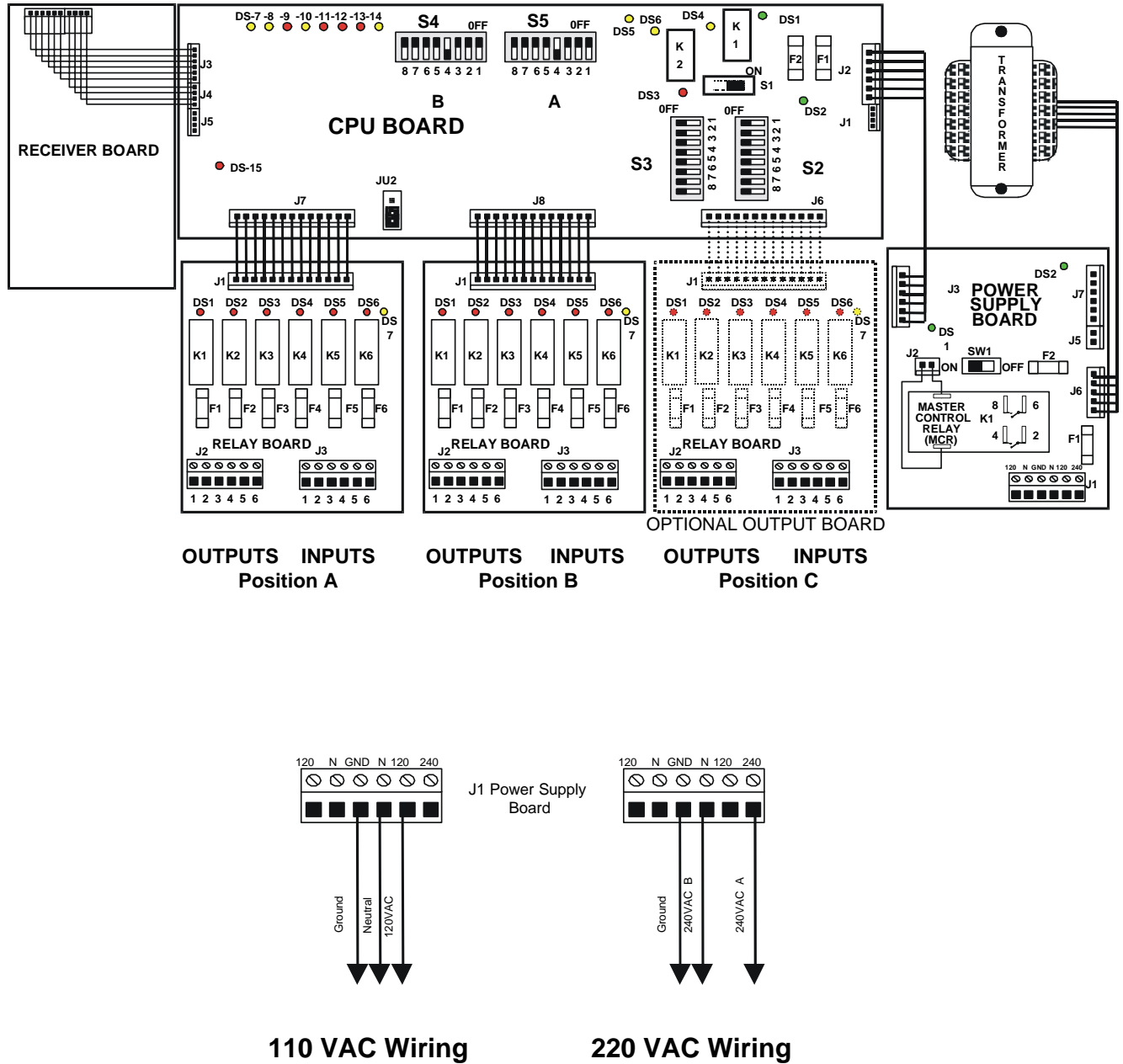

Figure A-2. 10K12 Wiring Layout

A-7. Crane Control Type Selection

The crane control type selection information is provided in [TABLE 1\(a\)](#) through [TABLE 1\(l\)](#). Each table defines a specific configuration and provides a wiring diagram, a programming diagram, and transmitter and receiver switch settings. The table for each configuration is provided on facing pages so that all information is easily accessible.

**Appendix A - 10K12/18 Pendant and SLTX
Transmitter Rrogramming (Continued)**

TABLE 1(a)

Crane Control Type Selection: 10K12 Single Speed TYPE 0 WIRING DIAGRAM

**STANDARD CONFIGURATION: ALL MOTIONS
(HOIST, TROLLEY and BRIDGE)**

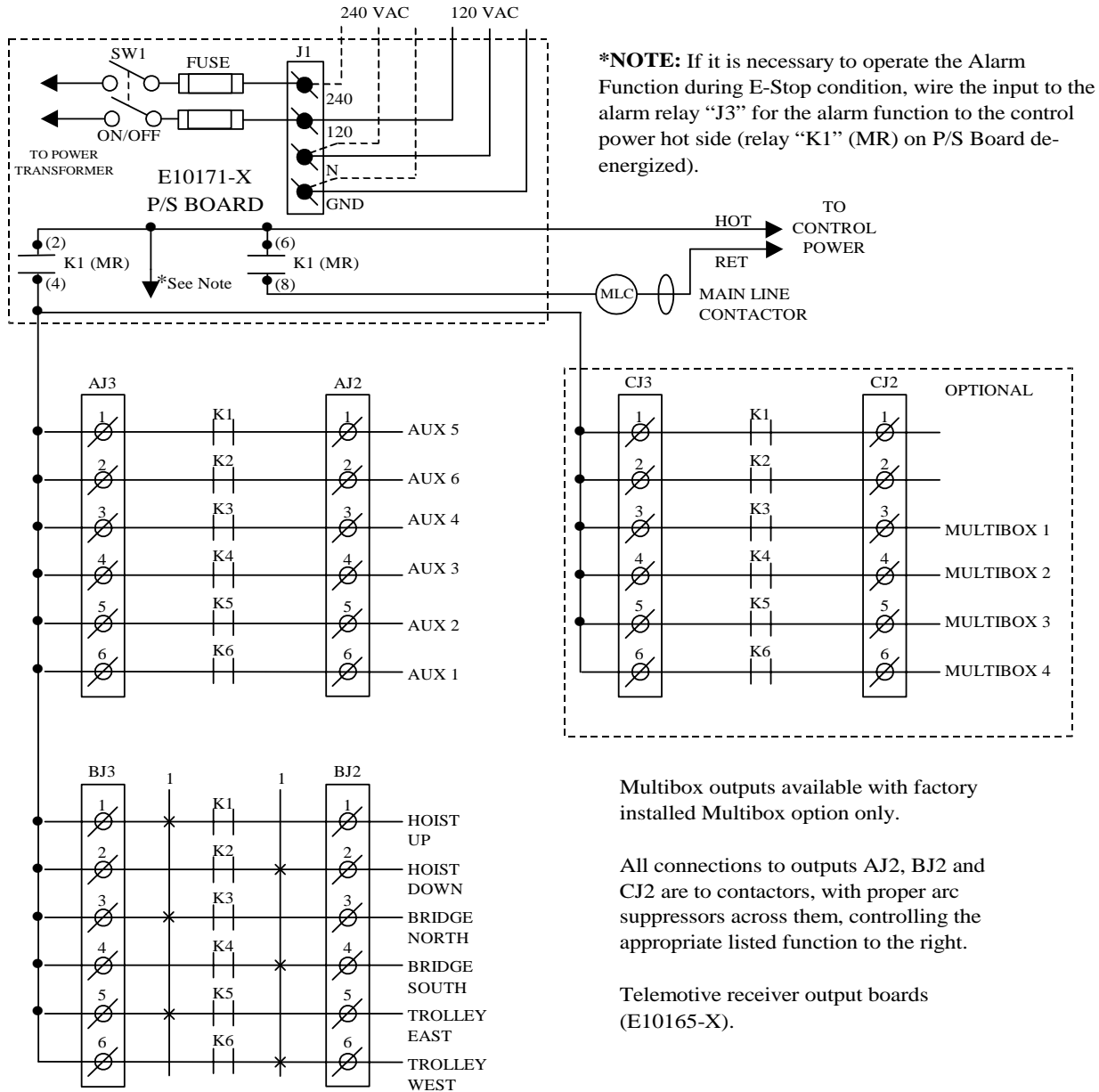

Multibox outputs available with factory installed Multibox option only.

All connections to outputs AJ2, BJ2 and CJ2 are to contactors, with proper arc suppressors across them, controlling the appropriate listed function to the right.

Telemotive receiver output boards (E10165-X).

*Appendix A - 10K12/18 Pendant and SLTX
Transmitter Programming (Continued)*

TABLE 1(a)

Crane Control Type Selection: 10K12 Single Speed **TYPE 0 PROGRAMMING**

**STANDARD CONFIGURATION: ALL MOTIONS
(HOIST, TROLLEY and BRIDGE)**

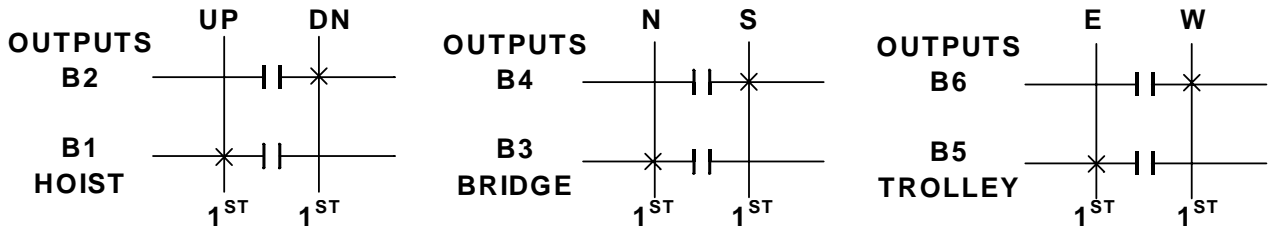

INDEPENDENT OUTPUTS



STANDARD OUTPUTS	STANDARD OUTPUTS	OPTIONAL OUTPUT BOARD OPTION #1
A1 AUX 5 (LATCHABLE S2-7)	B1 HOIST UP	C1
A2 AUX 6 (LATCHABLE S2-6)	B2 HOIST DOWN	C2
A3 AUX 4	B3 BRIDGE NORTH	C3 MULTIBOX 1
A4 AUX 3	B4 BRIDGE SOUTH	C4 MULTIBOX 2
A5 AUX 2	B5 TROLLEY EAST	C5 MULTIBOX 3
A6 AUX 1	B6 TROLLEY WEST	C6 MULTIBOX 4

Transmitter and Receiver Switch Select: Switch settings **Sw3-5** to **Sw3-7** are defined as follows (for Optional Output Board in the Receiver **Sw3-3** must be "ON" for Option #1 and "OFF" for Option #1):

TRANSMITTER SWITCH SETTINGS: TYPE Sw4-7 Sw4-6 Sw4-5
 0 OFF OFF OFF

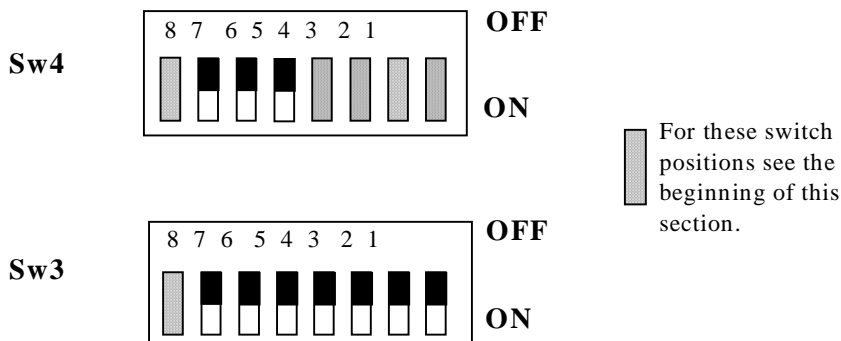

**Appendix A - 10K12/18 Pendant and SLTX
Transmitter Programming (Continued)**

TABLE 1(b)

Crane Control Type Selection: 10K12 2-Speed TYPE 0 WIRING DIAGRAM

**STANDARD CONFIGURATION: ALL MOTIONS
(HOIST, TROLLEY and BRIDGE)**

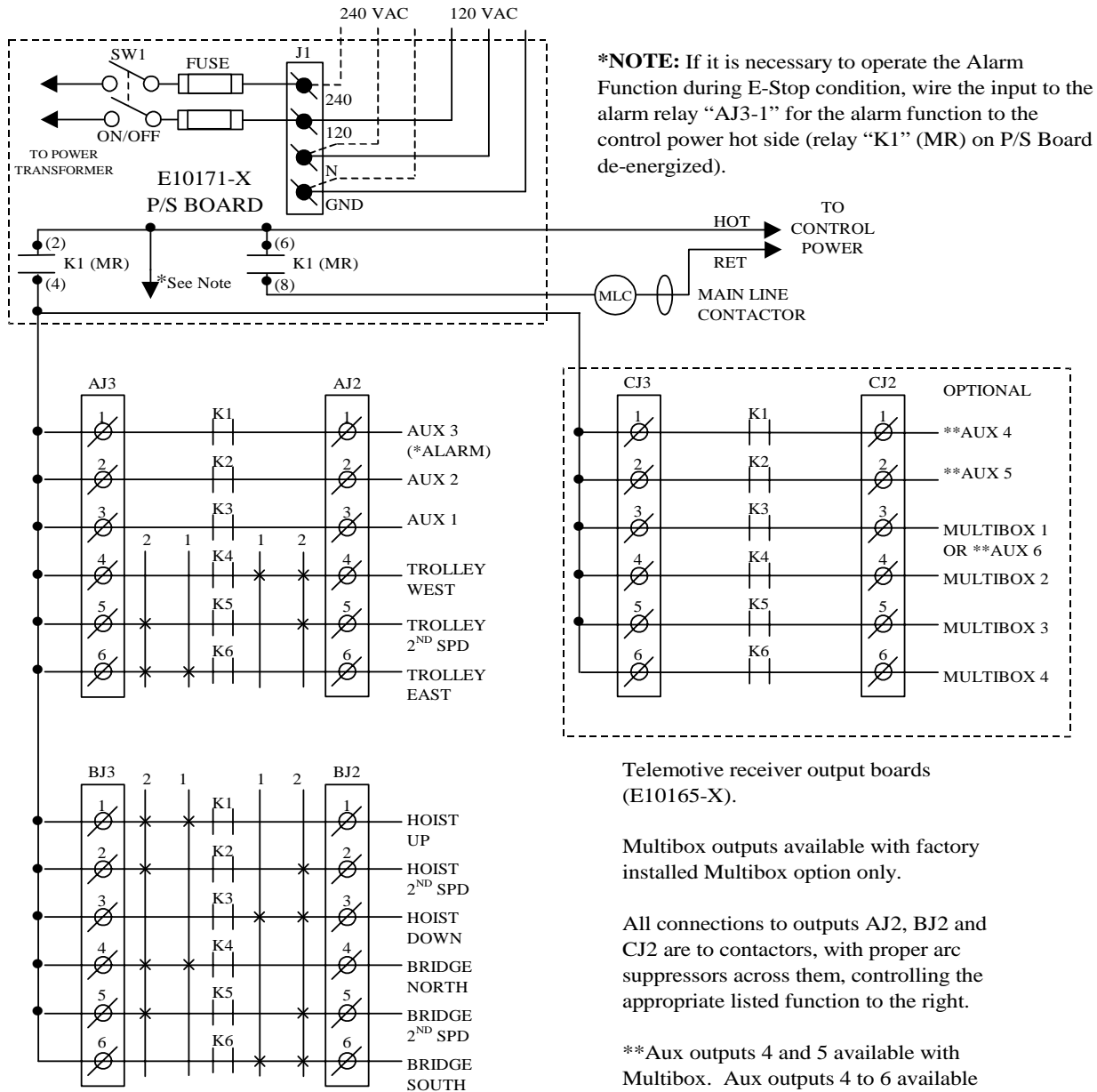

*Appendix A - 10K12/18 Pendant and SLTX
Transmitter Rrogramming (Continued)*

TABLE 1(b)

Crane Control Type Selection: 10K12 2-Speed TYPE 0 PROGRAMMING

STANDARD CONFIGURATION: ALL MOTIONS
(HOIST, TROLLEY and BRIDGE)

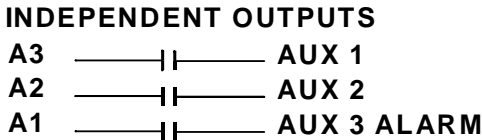
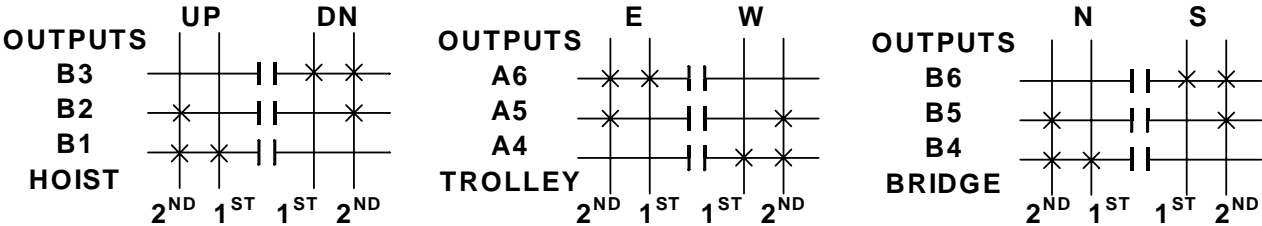

STANDARD OUTPUTS		STANDARD OUTPUTS		OPTIONAL OUTPUT BOARD OPTION #1		OPTIONAL OUTPUT BOARD OPTION #2	
A1	AUX 3 (ALARM)	B1	HOIST UP	C1	AUX 4	C1	AUX 4
A2	AUX 2 (LATCHABLE S2-6)	B2	HOIST 2 ND SPEED	C2	AUX 5	C2	AUX 5
A3	AUX 1 (LATCHABLE S2-7)	B3	HOIST DOWN	C3	MULTIBOX 1	C3	AUX 6
A4	TROLLEY WEST	B4	BRIDGE NORTH	C4	MULTIBOX 2	C4	
A5	TROLLEY 2 ND SPEED	B5	BRIDGE 2 ND SPEED	C5	MULTIBOX 3	C5	
A6	TROLLEY EAST	B6	BRIDGE SOUTH	C6	MULTIBOX 4	C6	

Transmitter and Receiver Switch Select: Switch settings Sw3-5 to Sw3-7 are defined as follows (for Optional Output Board in the Receiver Sw3-3 must be "ON" for Option #1 and "OFF" for Option #2):

TRANSMITTER SWITCH SETTINGS: TYPE Sw4-7 Sw4-6 Sw4-5
 0 OFF OFF OFF

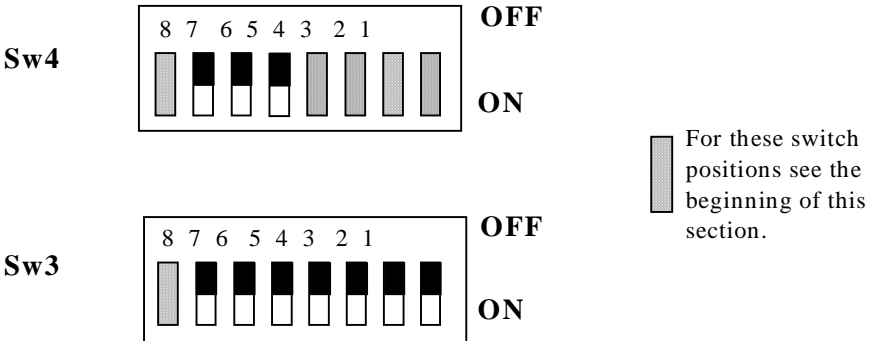

**Appendix A - 10K12/18 Pendant and SLTX
Transmitter Rrogramming (Continued)**

TABLE 1(c)

Crane Control Type Selection: 10K12 2-Speed TYPE 1 WIRING DIAGRAM

2-SPEED with DIRECTIONAL CONTROL: ALL MOTIONS

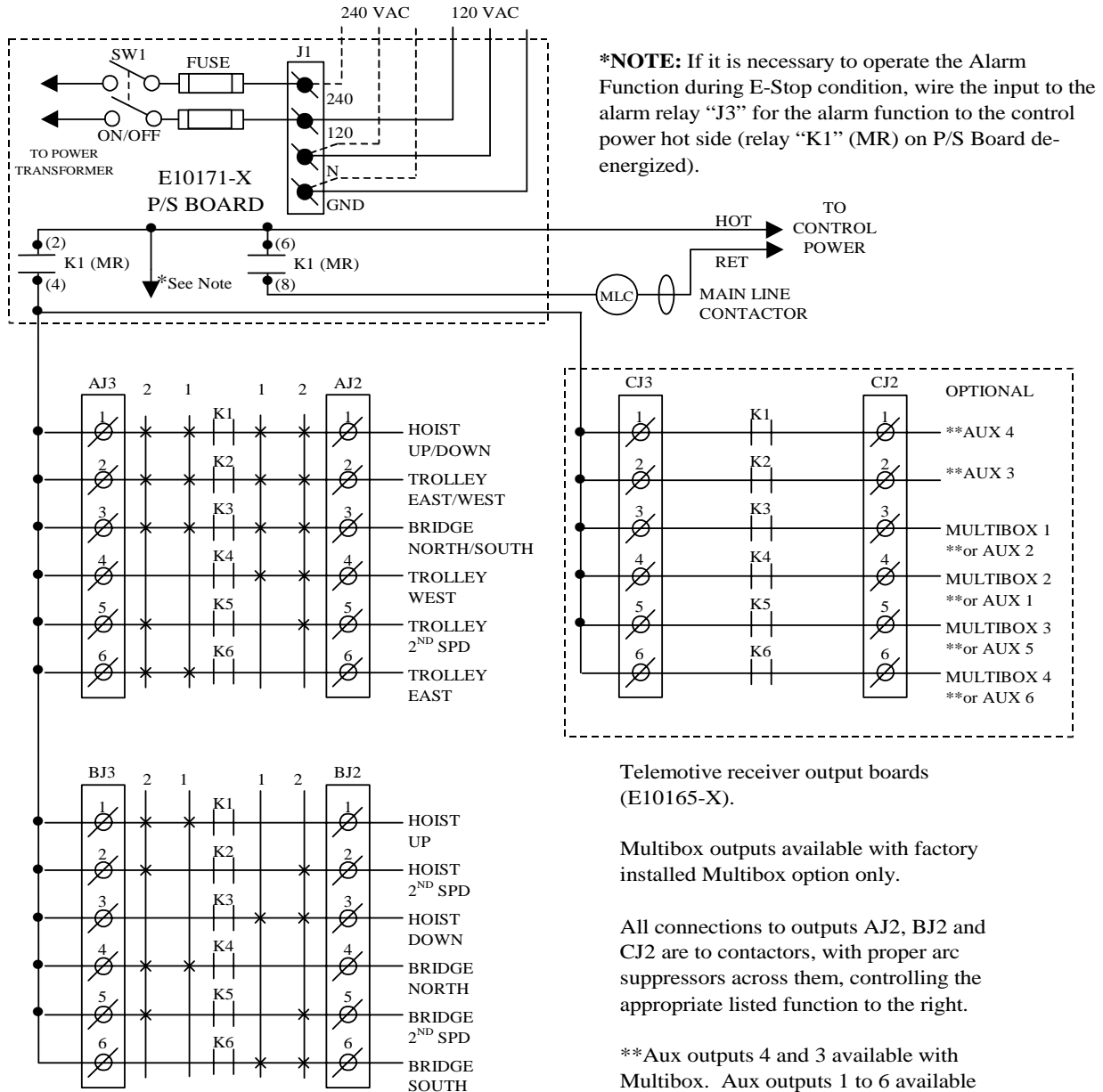

Telemotive receiver output boards (E10165-X).

Multibox outputs available with factory installed Multibox option only.

All connections to outputs AJ2, BJ2 and CJ2 are to contactors, with proper arc suppressors across them, controlling the appropriate listed function to the right.

**Aux outputs 4 and 3 available with Multibox. Aux outputs 1 to 6 available with Multibox disabled. Aux 5 and 6 require a special transmitter see your Telemotive representative.

**Appendix A - 10K12/18 Pendant and SLTX
Transmitter Rrogramming (Continued)**

TABLE 1(c)

Crane Control Type Selection: 10K12 2-Speed TYPE 1 PROGRAMMING

2-SPEED with DIRECTIONAL CONTROL: ALL MOTIONS

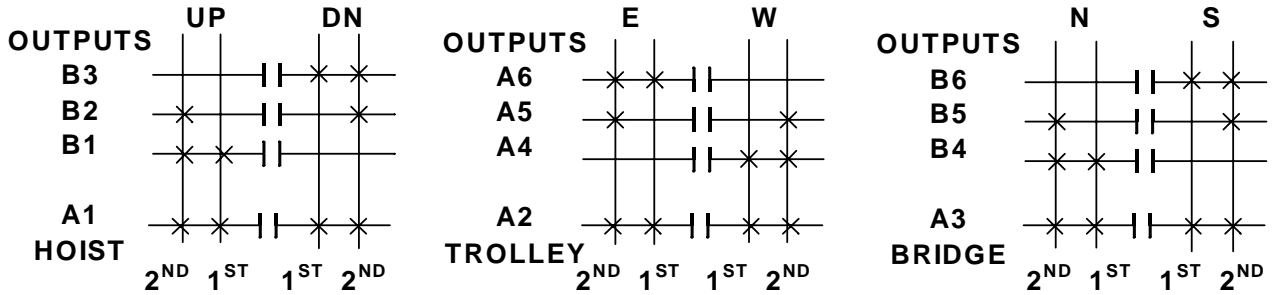

STANDARD OUTPUTS	STANDARD OUTPUTS	OPTIONAL OUTPUT BOARD OPTION #1	OPTIONAL OUTPUT BOARD OPTION #2
A1 HOIST UP/DOWN	B1 HOIST UP	C1 AUX 4	C1 AUX 4
A2 TROLLEY EAST/WEST	B2 HOIST 2 ND SPEED	C2 AUX 3	C2 AUX 3
A3 BRIDGE NORTH/SOUTH	B3 HOIST DOWN	C3 MULTIBOX 1	C3 AUX 2
A4 TROLLEY WEST	B4 BRIDGE NORTH	C4 MULTIBOX 2	C4 AUX 1
A5 TROLLEY 2 ND SPEED	B5 BRIDGE 2 ND SPEED	C5 MULTIBOX 3	C5 AUX 5
A6 TROLLEY EAST	B6 BRIDGE SOUTH	C6 MULTIBOX 4	C6 AUX 6

Transmitter and Receiver Switch Select: Switch settings Sw3-5 to Sw3-7 are defined as follows (for Optional Output Board in the Receiver Sw3-3 must be "ON" for Option #1 and "OFF" for Option #2):

TRANSMITTER SWITCH SETTINGS:

<u>TYPE</u>	<u>Sw4-7</u>	<u>Sw4-6</u>	<u>Sw4-5</u>
1	OFF	OFF	ON

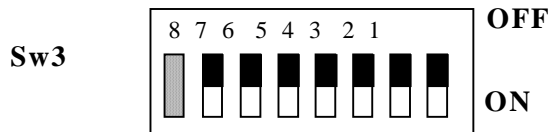
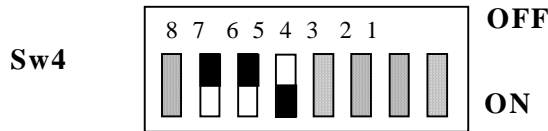

For these switch positions see the beginning of this section.

**Appendix A - 10K12/18 Pendant and SLTX
Transmitter Rrogramming (Continued)**

TABLE 1(d)

Crane Control Type Selection: 10K12 2-Speed TYPE 2 WIRING DIAGRAM

2-SPEED, 2-WINDINGS: ALL MOTIONS

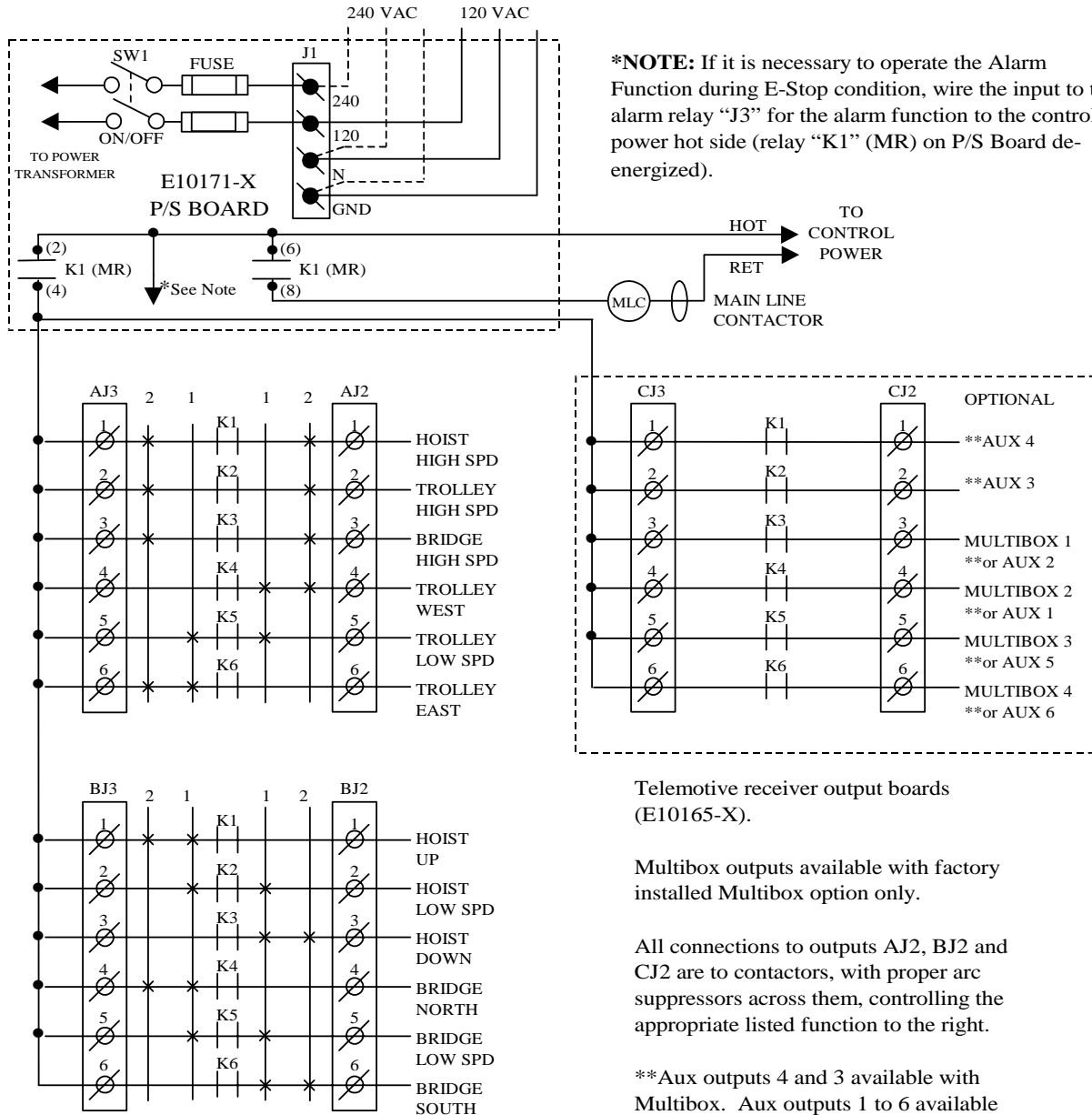

Telemotive receiver output boards (E10165-X).

Multibox outputs available with factory installed Multibox option only.

All connections to outputs AJ2, BJ2 and CJ2 are to contactors, with proper arc suppressors across them, controlling the appropriate listed function to the right.

**Aux outputs 4 and 3 available with Multibox. Aux outputs 1 to 6 available with Multibox disabled. Aux 5 and 6 require a special transmitter see your Telemotive representative.

**Appendix A - 10K12/18 Pendant and SLTX
Transmitter Rrogramming (Continued)**

TABLE 1(d)

Crane Control Type Selection: 10K12 2-Speed TYPE 2 PROGRAMMING

2-SPEED, 2-WINDINGS: ALL MOTIONS

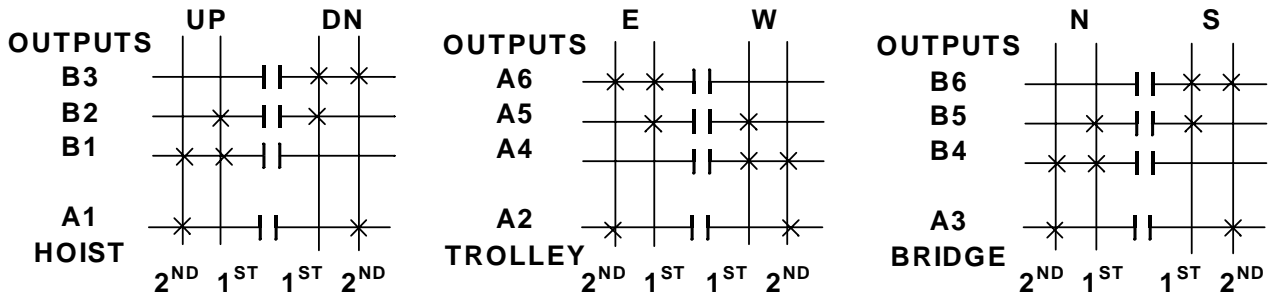

STANDARD OUTPUTS	STANDARD OUTPUTS	OPTIONAL OUTPUT BOARD OPTION #1	OPTIONAL OUTPUT BOARD OPTION #2
A1 HOIST HIGH SPEED	B1 HOIST UP	C1 AUX 4	C1 AUX 4
A2 TROLLEY HIGH SPEED	B2 HOIST LOW SPEED	C2 AUX 3	C2 AUX 3
A3 BRIDGE HIGH SPEED	B3 HOIST DOWN	C3 MULTIBOX 1	C3 AUX 2
A4 TROLLEY WEST	B4 BRIDGE NORTH	C4 MULTIBOX 2	C4 AUX 1
A5 TROLLEY 2 ND SPEED	B5 BRIDGE LOW SPEED	C5 MULTIBOX 3	C5 AUX 5
A6 TROLLEY EAST	B6 BRIDGE SOUTH	C6 MULTIBOX 4	C6 AUX 6

Transmitter and Receiver Switch Select: Switch settings Sw3-5 to Sw3-7 are defined as follows (for Optional Output Board in the Receiver Sw3-3 must be "ON" for Option #1 and "OFF" for Option #2):

TRANSMITTER SWITCH SETTINGS: TYPE Sw4-7 Sw4-6 Sw4-5
2 OFF ON OFF

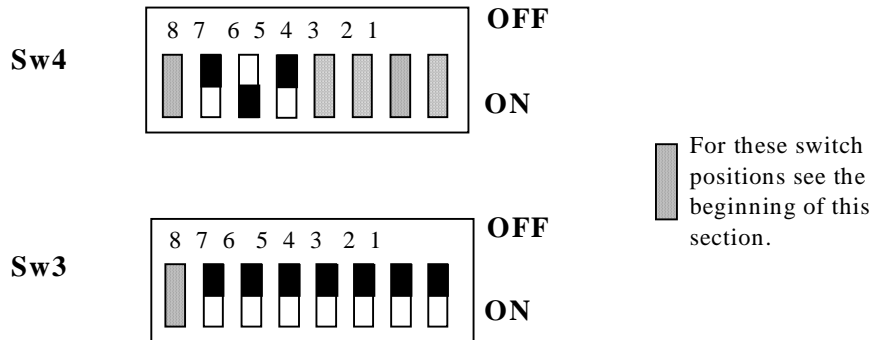

**Appendix A - 10K12/18 Pendant and SLTX
Transmitter Rrogramming (Continued)**

TABLE 1(e)

Crane Control Type Selection: 10K12 2-Speed TYPE 3 WIRING DIAGRAM

ACCO CONTROLS: ALL MOTIONS

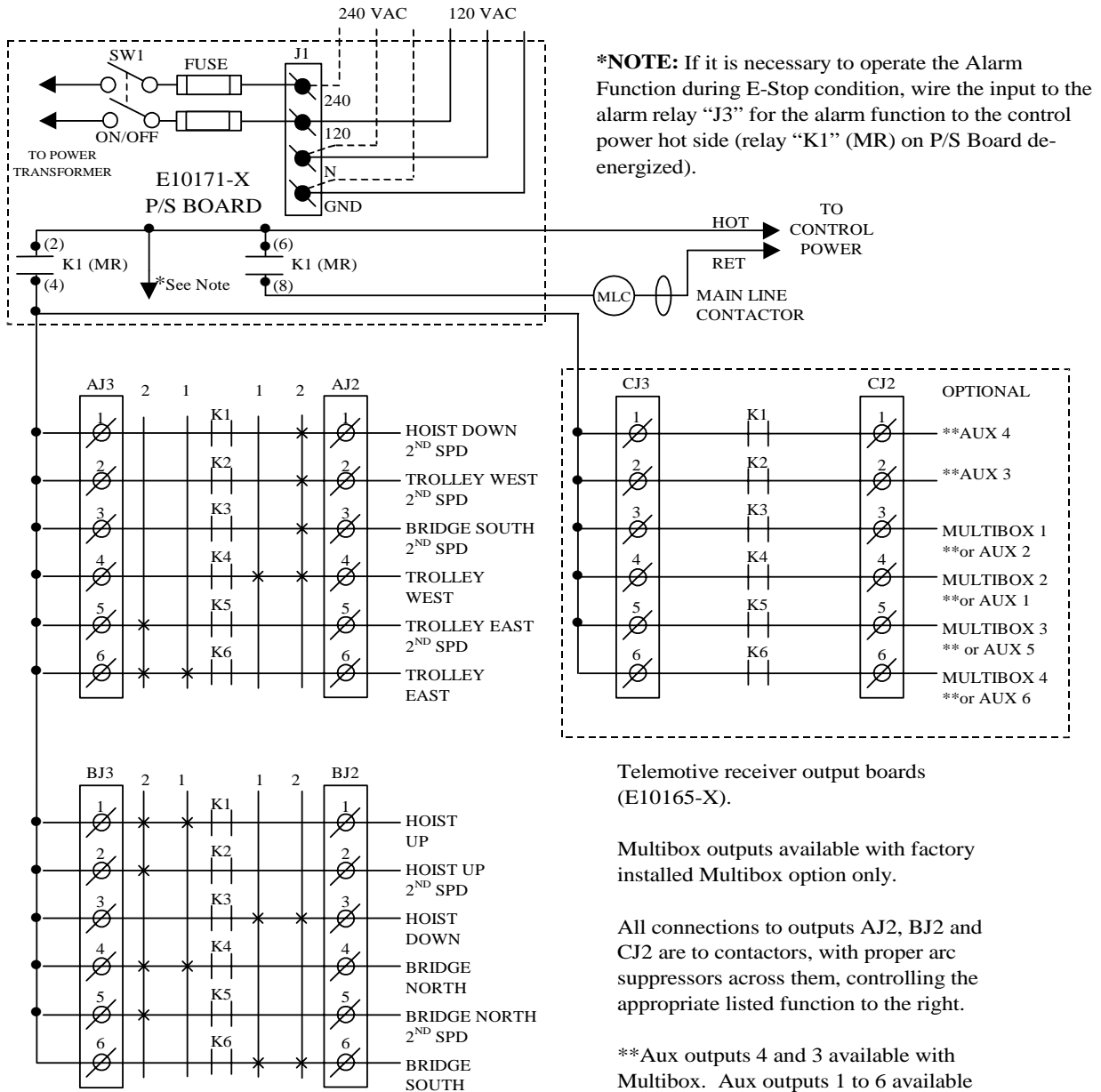

**Appendix A - 10K12/18 Pendant and SLTX
Transmitter Rrogramming (Continued)**

TABLE 1(e)

Crane Control Type Selection: 10K12 2-Speed TYPE 3 PROGRAMMING

ACCO CONTROLS: ALL MOTIONS

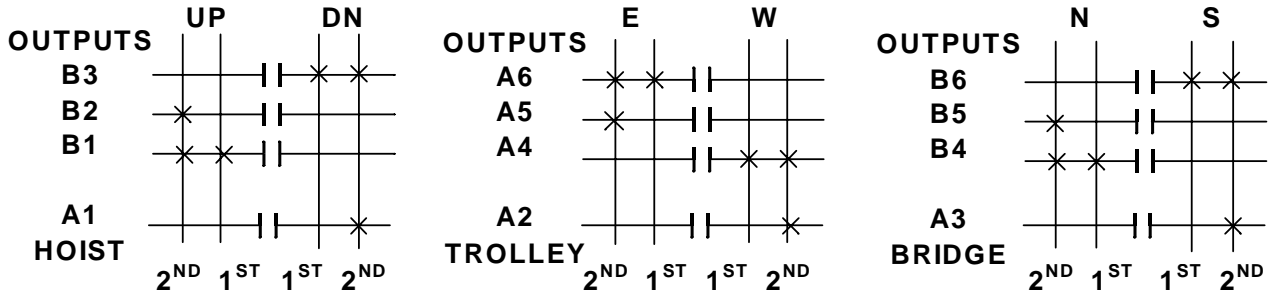

STANDARD OUTPUTS	STANDARD OUTPUTS	OPTIONAL OUTPUT BOARD OPTION #1	OPTIONAL OUTPUT BOARD OPTION #2
A1 HOIST DOWN 2 ND SPEED	B1 HOIST UP	C1 AUX 4	C1 AUX 4
A2 TROLLEY WEST 2 ND SPEED	B2 HOIST UP 2 ND SPEED	C2 AUX 3	C2 AUX 3
A3 BRIDGE SOUTH 2 ND SPEED	B3 HOIST DOWN	C3 MULTIBOX 1	C3 AUX 2
A4 TROLLEY WEST	B4 BRIDGE NORTH	C4 MULTIBOX 2	C4 AUX 1
A5 TROLLEY EAST 2 ND SPEED	B5 BRIDGE NORTH 2 ND SPEED	C5 MULTIBOX 3	C5 AUX 5
A6 TROLLEY EAST	B6 BRIDGE SOUTH	C6 MULTIBOX 4	C6 AUX 6

Transmitter and Receiver Switch Select: Switch settings Sw3-5 to Sw3-7 are defined as follows (for Optional Output Board in the Receiver Sw3-3 must be "ON" for Option #1 and "OFF" for Option #2):

TRANSMITTER SWITCH SETTINGS: TYPE Sw4-7 Sw4-6 Sw4-5
 3 OFF ON ON



█ For these switch positions see the beginning of this section.

**Appendix A - 10K12/18 Pendant and SLTX
Transmitter Rrogramming (Continued)**

TABLE 1(f)

Crane Control Type Selection: 10K12 2-Speed TYPE 4 WIRING DIAGRAM

**P&H: 2-SPEED, 2-WINDINGS for HOIST and TROLLEY:
STANDARD BRIDGE**

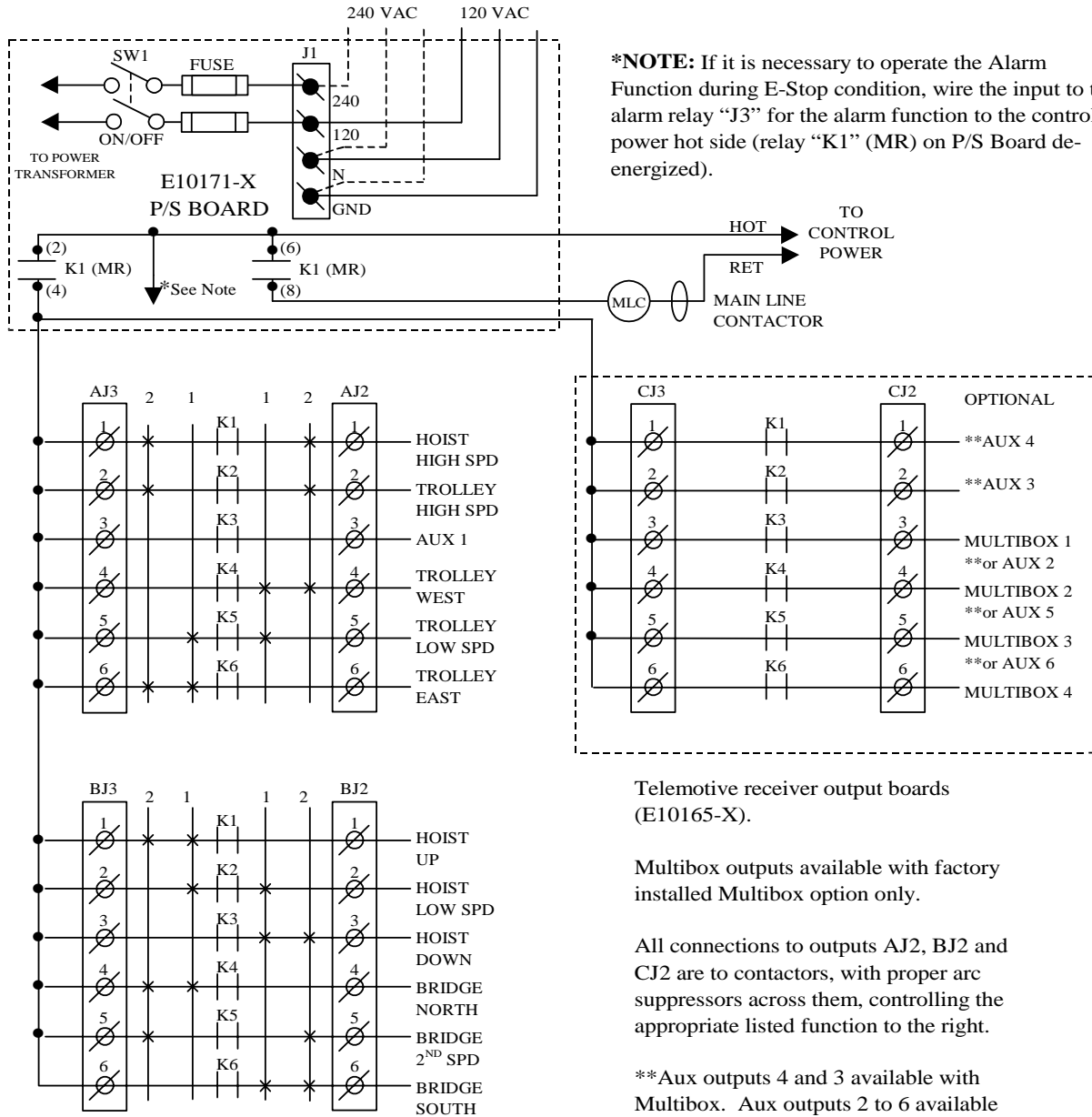

Telemotive receiver output boards (E10165-X).

Multibox outputs available with factory installed Multibox option only.

All connections to outputs AJ2, BJ2 and CJ2 are to contactors, with proper arc suppressors across them, controlling the appropriate listed function to the right.

**Aux outputs 4 and 3 available with Multibox. Aux outputs 2 to 6 available with Multibox disabled. Aux 5 and 6 require a special transmitter see your Telemotive representative.

*Appendix A - 10K12/18 Pendant and SLTX
Transmitter Rrogramming (Continued)*

TABLE 1(f)

Crane Control Type Selection: 10K12 2-Speed TYPE 4 PROGRAMMING

**P&H: 2-SPEED, 2-WINDINGS for HOIST and TROLLEY:
STANDARD BRIDGE**

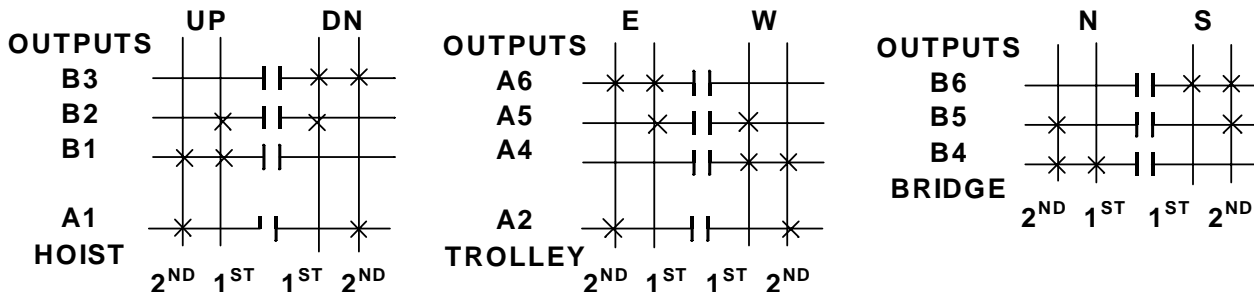

INDEPENDENT OUTPUTS
A3 ————| |————— AUX 1

STANDARD OUTPUTS	STANDARD OUTPUTS	OPTIONAL OUTPUT BOARD OPTION #1	OPTIONAL OUTPUT BOARD OPTION #2
A1 HOIST HIGH SPEED	B1 HOIST UP	C1 AUX 4	C1 AUX 4
A2 TROLLEY HIGH SPEED	B2 HOIST LOW SPEED	C2 AUX 3	C2 AUX 3
A3 AUX 1 (LATCHABLE S2-7)	B3 HOIST DOWN	C3 MULTIBOX 1	C3 AUX 2
A4 TROLLEY WEST	B4 BRIDGE NORTH	C4 MULTIBOX 2	C4 AUX 5
A5 TROLLEY LOW SPEED	B5 BRIDGE 2 ND SPEED	C5 MULTIBOX 3	C5 AUX 6
A6 TROLLEY EAST	B6 BRIDGE SOUTH	C6 MULTIBOX 4	C6

Transmitter and Receiver Switch Select: Switch settings Sw3-5 to Sw3-7 are defined as follows (for Optional Output Board in the Receiver Sw3-3 must be “ON” for Option #1 and “OFF” for Option #2):

TRANSMITTER SWITCH SETTINGS: TYPE Sw4-7 Sw4-6 Sw4-5
 4 ON OFF OFF

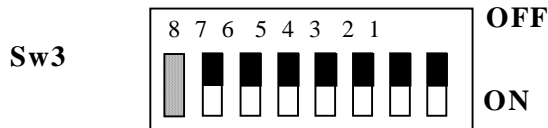
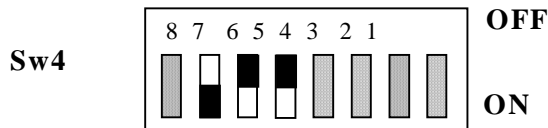

For these switch positions see the beginning of this section.

**Appendix A - 10K12/18 Pendant and SLTX
Transmitter Rrogramming (Continued)**

TABLE 1(g)

Crane Control Type Selection: 10K12 2-Speed TYPE 5 WIRING DIAGRAM

**P&H: 2-SPEED, 2-WINDINGS for HOIST:
STANDARD BRIDGE and TROLLEY**

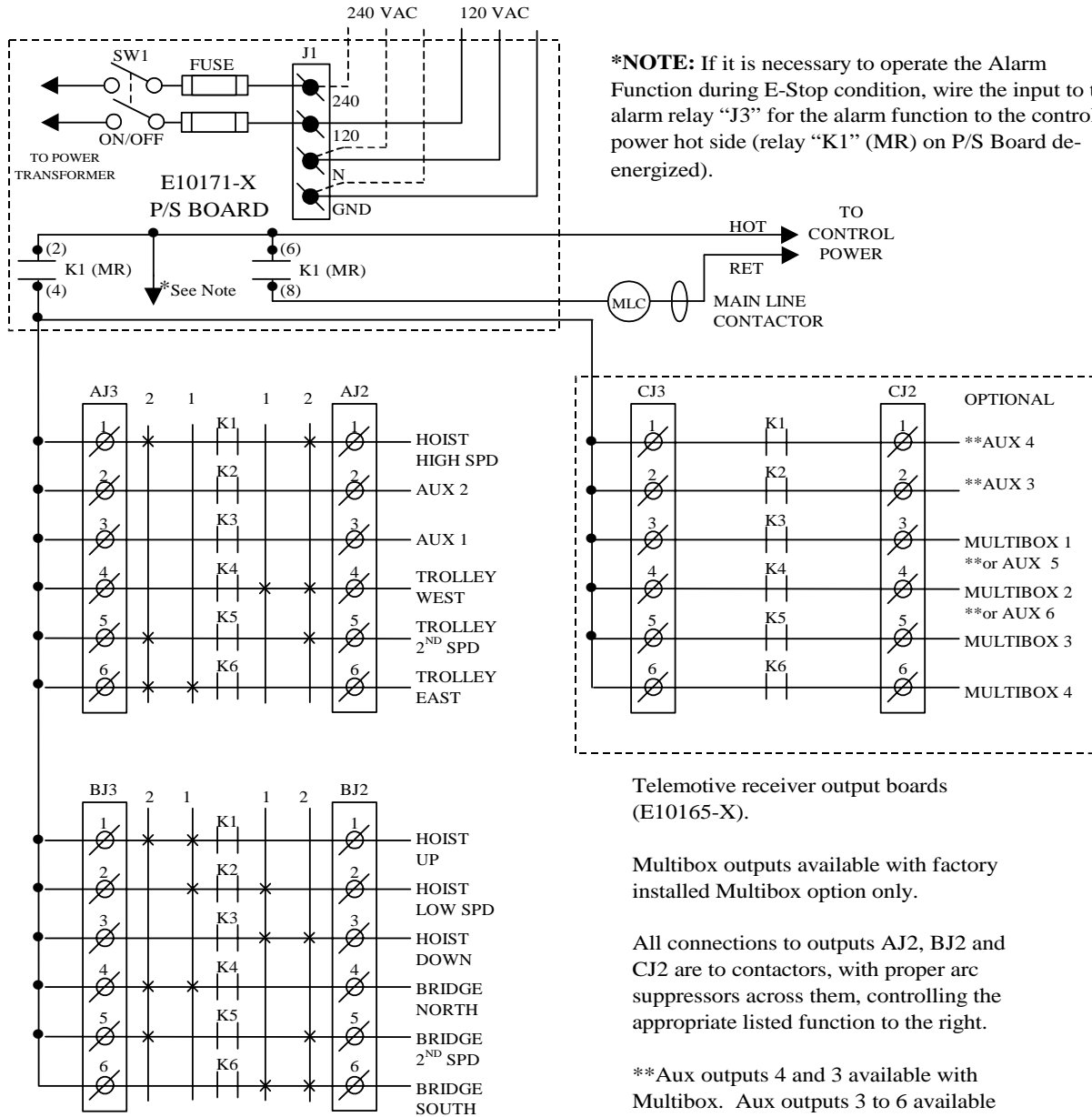

**Appendix A - 10K12/18 Pendant and SLTX
Transmitter Rrogramming (Continued)**

TABLE 1(g)

Crane Control Type Selection: 10K12 2-Speed TYPE 5 PROGRAMMING

**P&H: 2-SPEED, 2-WINDINGS for HOIST:
STANDARD BRIDGE and TROLLEY**

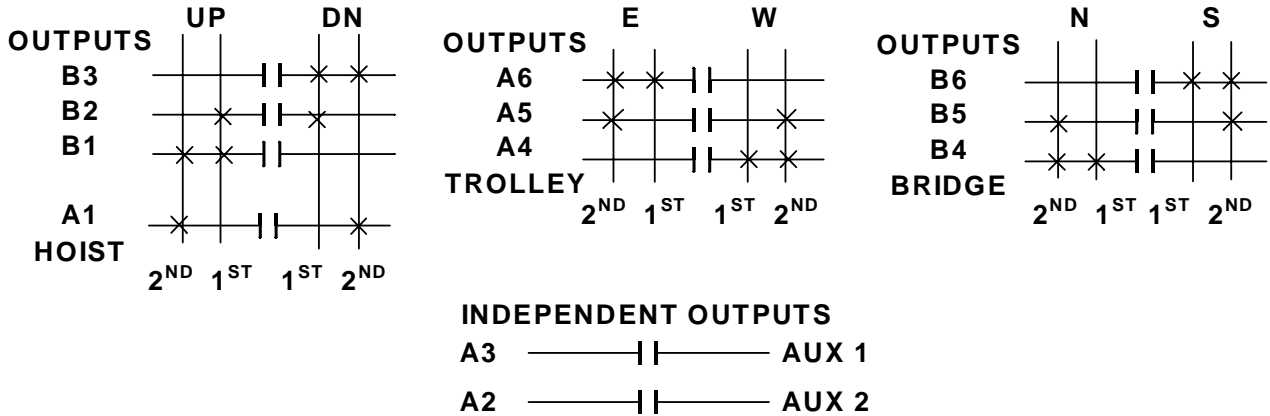

STANDARD OUTPUTS	STANDARD OUTPUTS	OPTIONAL OUTPUT BOARD OPTION #1	OPTIONAL OUTPUT BOARD OPTION #2
A1 HOIST HIGH SPEED	B1 HOIST UP	C1 AUX 4	C1 AUX 4
A2 AUX 2 (LATCHABLE S2-6)	B2 HOIST LOW SPEED	C2 AUX 3	C2 AUX 3
A3 AUX 1 (LATCHABLE S2-7)	B3 HOIST DOWN	C3 MULTIBOX 1	C3 AUX 5
A4 TROLLEY WEST	B4 BRIDGE NORTH	C4 MULTIBOX 2	C4 AUX 6
A5 TROLLEY 2 ND SPEED	B5 BRIDGE 2 ND SPEED	C5 MULTIBOX 3	C5
A6 TROLLEY EAST	B6 BRIDGE SOUTH	C6 MULTIBOX 4	C6

Transmitter and Receiver Switch Select: Switch settings Sw3-5 to Sw3-7 are defined as follows (for Optional Output Board in the Receiver Sw3-3 must be "ON" for Option #1 and "OFF" for Option #2):

TRANSMITTER SWITCH SETTINGS:

	<u>TYPE</u>	<u>Sw4-7</u>	<u>Sw4-6</u>	<u>Sw4-5</u>
	5	ON	OFF	ON

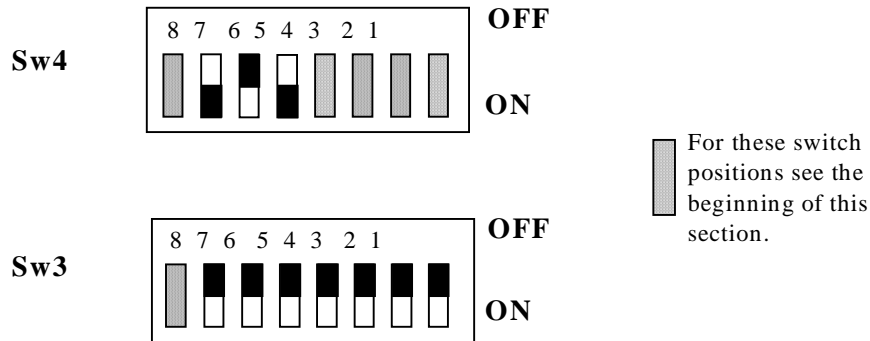

**Appendix A - 10K12/18 Pendant and SLTX
Transmitter Rrogramming (Continued)**

TABLE 1(h)

Crane Control Type Selection: 10K12 2-Speed TYPE 6 WIRING DIAGRAM

**DEMAG: 2-SPEED, 2-WINDINGS for HOIST:
STANDARD BRIDGE and TROLLEY**

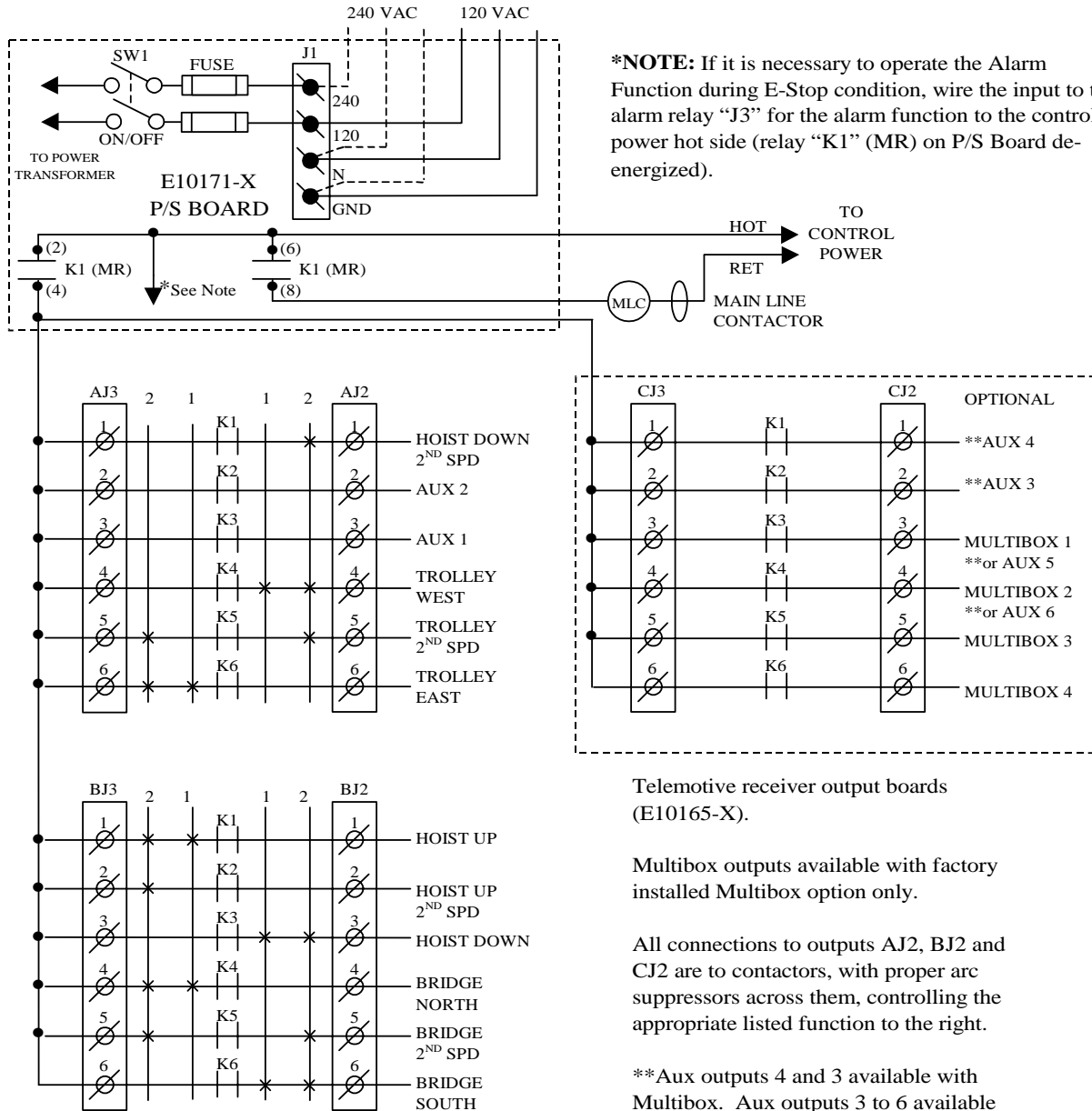

***NOTE:** If it is necessary to operate the Alarm Function during E-Stop condition, wire the input to the alarm relay “J3” for the alarm function to the control power hot side (relay “K1” (MR) on P/S Board de-energized).

Telemotive receiver output boards (E10165-X).

Multibox outputs available with factory installed Multibox option only.

All connections to outputs AJ2, BJ2 and CJ2 are to contactors, with proper arc suppressors across them, controlling the appropriate listed function to the right.

**Aux outputs 4 and 3 available with Multibox. Aux outputs 3 to 6 available with Multibox disabled. Aux 5 and 6 require a special transmitter see your Telemotive representative.

**Appendix A - 10K12/18 Pendant and SLTX
Transmitter Rrogramming (Continued)**

TABLE 1(h)

Crane Control Type Selection: 10K12 2-Speed TYPE 6 PROGRAMMING

**DEMAG: 2-SPEED, 2-WINDINGS for HOIST:
STANDARD BRIDGE and TROLLEY**

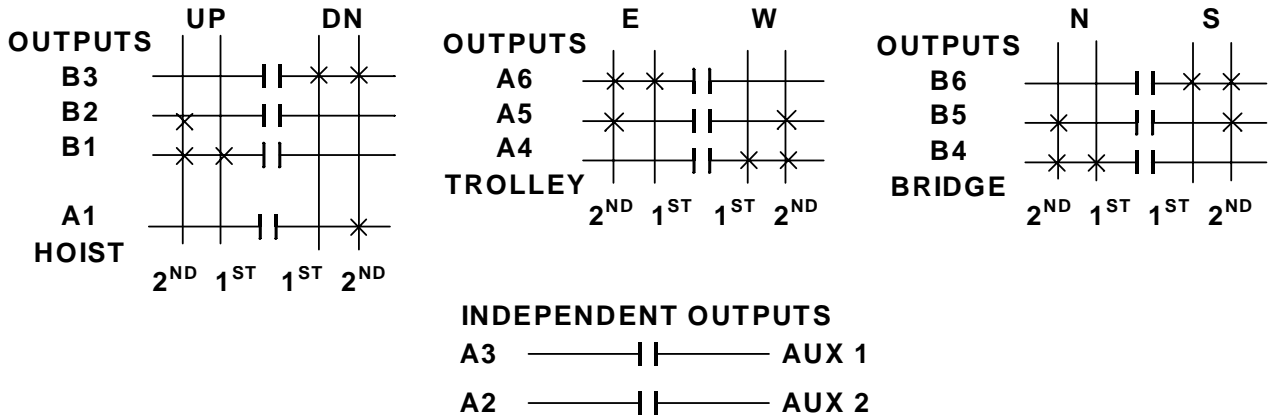

STANDARD OUTPUTS	STANDARD OUTPUTS	OPTIONAL OUTPUT BOARD OPTION #1	OPTIONAL OUTPUT BOARD OPTION #2
A1 HOIST DOWN 2 ND SPEED	B1 HOIST UP	C1 AUX 4	C1 AUX 4
A2 AUX 2 (LATCHABLE S2-6)	B2 HOIST UP 2 ND SPEED	C2 AUX 3	C2 AUX 3
A3 AUX 1 (LATCHABLE S2-7)	B3 HOIST DOWN	C3 MULTIBOX 1	C3 AUX 5
A4 TROLLEY WEST	B4 BRIDGE NORTH	C4 MULTIBOX 2	C4 AUX 6
A5 TROLLEY 2 ND SPEED	B5 BRIDGE 2 ND SPEED	C5 MULTIBOX 3	C5
A6 TROLLEY EAST	B6 BRIDGE SOUTH	C6 MULTIBOX 4	C6

Transmitter and Receiver Switch Select: Switch settings Sw3-5 to Sw3-7 are defined as follows (for Optional Output Board in the Receiver Sw3-3 must be “ON” for Option #1 and “OFF” for Option #2):

TRANSMITTER SWITCH SETTINGS: TYPE Sw4-7 Sw4-6 Sw4-5
 6 ON ON OFF

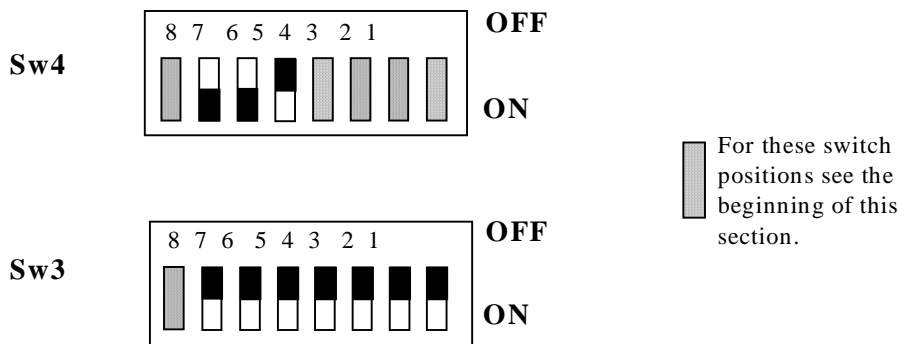

**Appendix A - 10K12/18 Pendant and SLTX
Transmitter Rrogramming (Continued)**

TABLE 1(i)

Crane Control Type Selection: 10K12 CONFIGURATION 1 WIRING DIAGRAM

STANDARD 2-SPEED 4 MOTOR SYSTEM

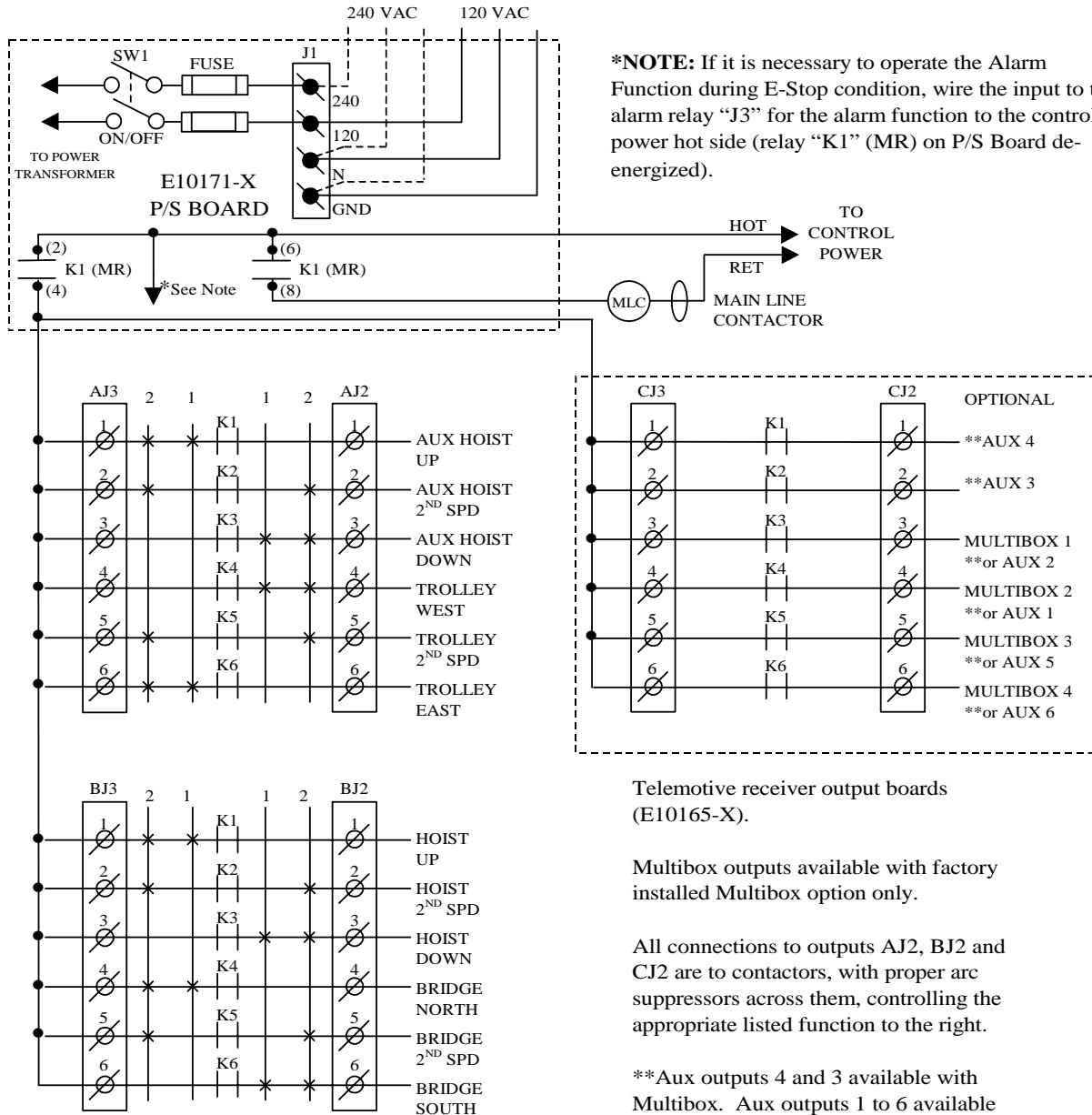

Telemotive receiver output boards (E10165-X).

Multibox outputs available with factory installed Multibox option only.

All connections to outputs AJ2, BJ2 and CJ2 are to contactors, with proper arc suppressors across them, controlling the appropriate listed function to the right.

**Aux outputs 4 and 3 available with Multibox. Aux outputs 1 to 6 available with Multibox disabled. Aux 5 and 6 require a special transmitter see your Telemotive representative

**Appendix A - 10K12/18 Pendant and SLTX
Transmitter Programming (Continued)**

TABLE 1(i)

Crane Control Type Selection: 10K12 CONFIGURATION 1 PROGRAMMING

STANDARD 2-SPEED 4 MOTOR SYSTEM

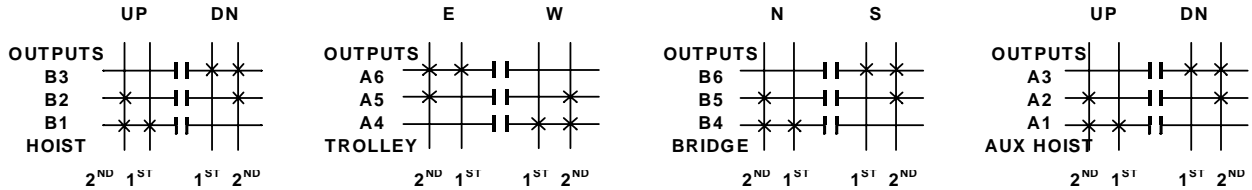

STANDARD OUTPUTS	STANDARD OUTPUTS	OPTIONAL OUTPUT BOARD OPTION #1	OPTIONAL OUTPUT BOARD OPTION #2
A1 AUX HOIST UP	B1 HOIST UP	C1 AUX 4	C1 AUX 4
A2 AUX HOIST 2 ND SPEED	B2 HOIST 2 ND SPEED	C2 AUX 3	C2 AUX 3
A3 AUX HOIST DOWN	B3 HOIST DOWN	C3 MULTIBOX 1	C3 AUX 2
A4 TROLLEY WEST	B4 BRIDGE NORTH	C4 MULTIBOX 2	C4 AUX 1
A5 TROLLEY 2 ND SPEED	B5 BRIDGE 2 ND SPEED	C5 MULTIBOX 3	C5 AUX 5
A6 TROLLEY EAST	B6 BRIDGE SOUTH	C6 MULTIBOX 4	C6 AUX 6

Transmitter and Receiver Switch Select: Switch settings Sw3-5 to Sw3-7 are defined as follows (for Optional Output Board in the Receiver Sw3-3 must be "ON" for Option #1 and "OFF" for Option #2):

TRANSMITTER SWITCH SETTINGS: Conf. 1 Sw4-2 ON Sw4-1 OFF

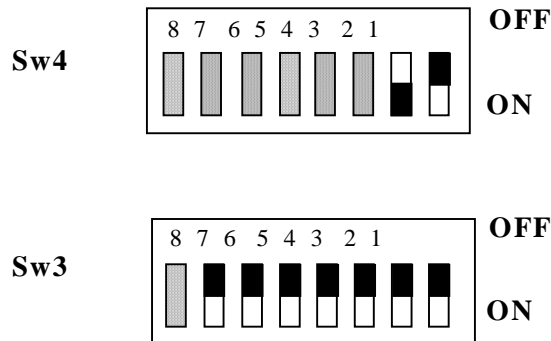

For these switch positions see the beginning of this section.

**Appendix A - 10K12/18 Pendant and SLTX
Transmitter Rrogramming (Continued)**

TABLE 1(j)

Crane Control Type Selection: 10K12 CONFIGURATION 2 WIRING DIAGRAM

**STANDARD 2-SPEED 3, 4 & 5 MOTOR SYSTEM
(EXTERNAL SELECT VERSION A)**

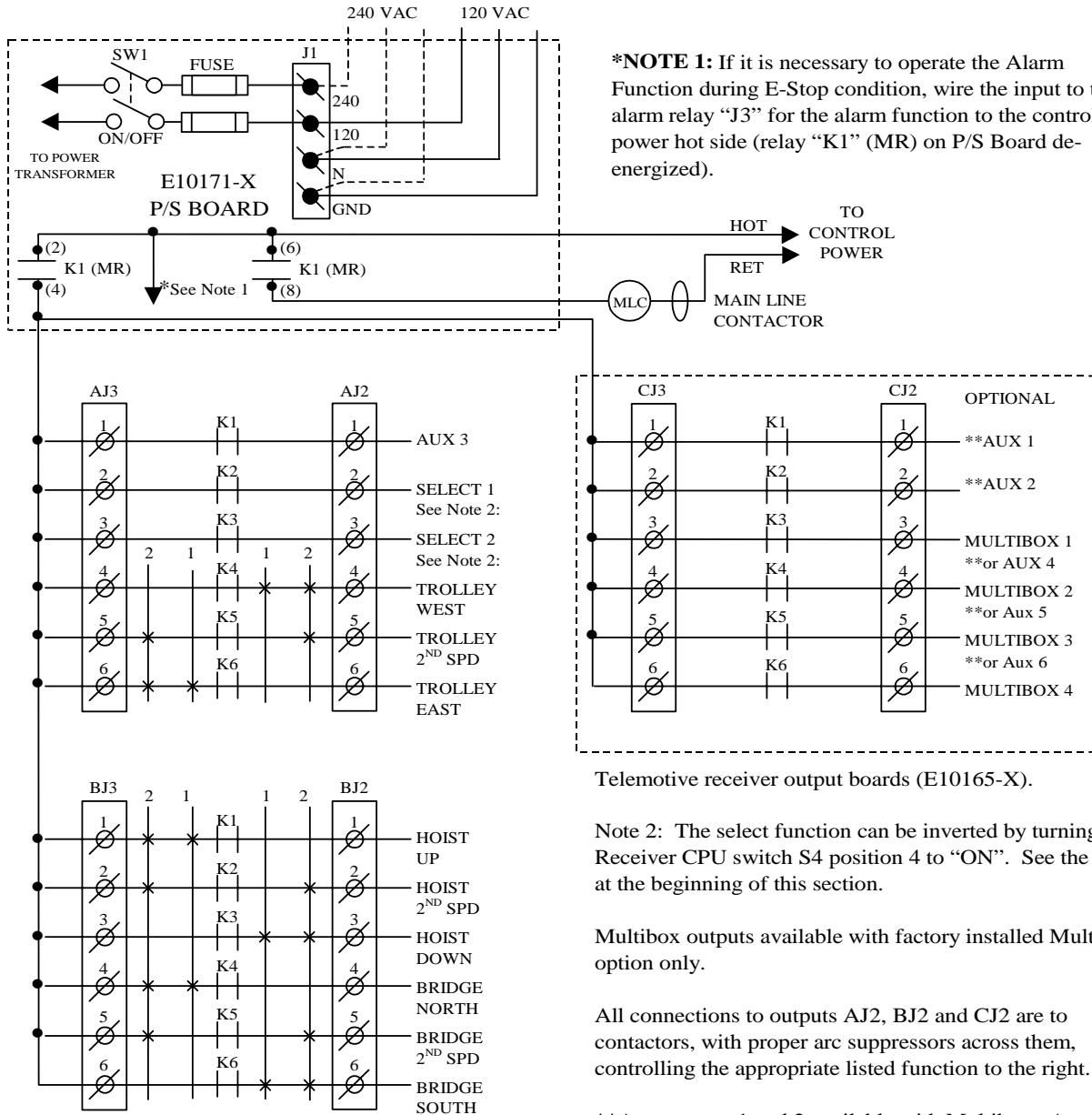
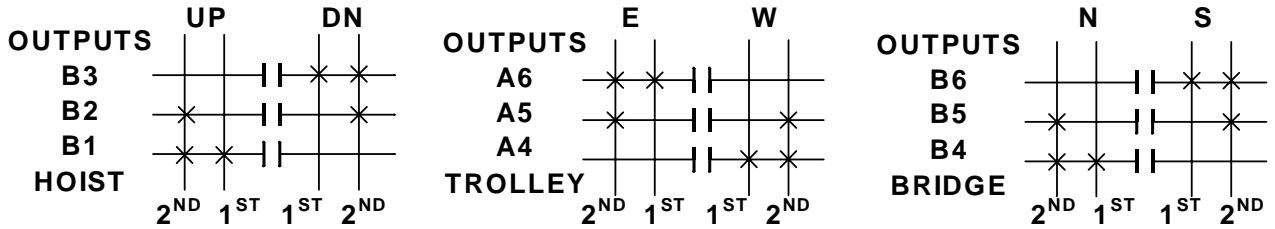

TABLE 1(j)

Crane Control Type Selection: 10K12 CONFIGURATION 2 PROGRAMMING

STANDARD 2-SPEED 3, 4 & 5 MOTOR SYSTEM
(EXTERNAL SELECT VERSION A)



INDEPENDENT OUTPUTS

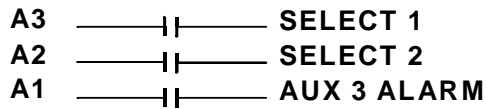

STANDARD OUTPUTS	STANDARD OUTPUTS	OPTIONAL OUTPUT BOARD OPTION #1	OPTIONAL OUTPUT BOARD OPTION #2
A1 AUX 3 (ALARM)	B1 HOIST UP	C1 AUX 1	C1 AUX 1
A2 SELECT 1	B2 HOIST 2 ND SPEED	C2 AUX 2	C2 AUX 2
A3 SELECT 2	B3 HOIST DOWN	C3 MULTIBOX 1	C3 AUX 4
A4 TROLLEY WEST	B4 BRIDGE NORTH	C4 MULTIBOX 2	C4 AUX 5
A5 TROLLEY 2 ND SPEED	B5 BRIDGE 2 ND SPEED	C5 MULTIBOX 3	C5 AUX 6
A6 TROLLEY EAST	B6 BRIDGE SOUTH	C6 MULTIBOX 4	C6

Transmitter and Receiver Switch Select: Switch settings Sw3-5 to Sw3-7 are defined as follows (for Optional Output Board in the Receiver Sw3-3 must be "ON" for Option #1 and "OFF" for Option #2):

TRANSMITTER SWITCH SETTINGS: Conf. Sw4-2 Sw4-1
 2 ON ON

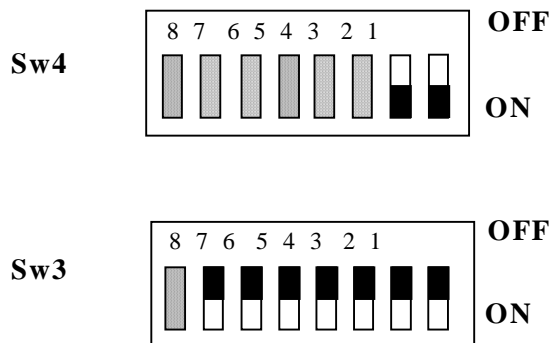

For these switch positions see the beginning of this section.

**Appendix A - 10K12/18 Pendant and SLTX
Transmitter Rrogramming (Continued)**

TABLE 1(k)

Crane Control Type Selection: 10K12 CONFIGURATION 3 WIRING DIAGRAM

**STANDARD 2-SPEED 3, 4 & 5 MOTOR SYSTEM
(EXTERNAL SELECT VERSION B)**

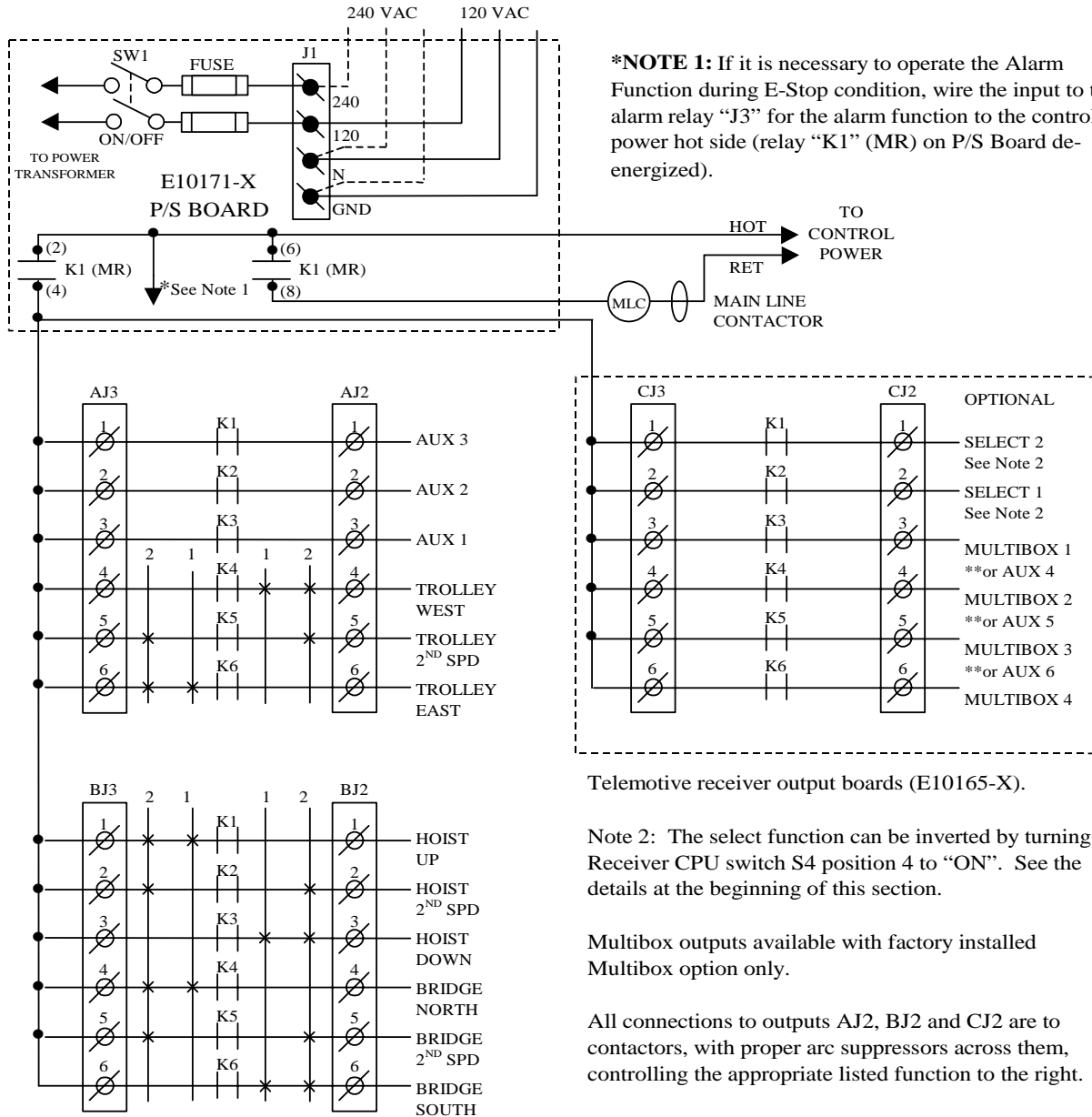

Telemotive receiver output boards (E10165-X).

Note 2: The select function can be inverted by turning Receiver CPU switch S4 position 4 to "ON". See the details at the beginning of this section.

Multibox outputs available with factory installed Multibox option only.

All connections to outputs AJ2, BJ2 and CJ2 are to contactors, with proper arc suppressors across them, controlling the appropriate listed function to the right.

** Aux outputs 4 to 6 available with Multibox disabled. Aux 5 and 6 require a special transmitter see your Telemotive representative.

*Appendix A - 10K12/18 Pendant and SLTX
Transmitter Rrogramming (Continued)*

TABLE 1(k)

Crane Control Type Selection: 10K12 CONFIGURATION 3 PROGRAMMING

**STANDARD 2-SPEED 3, 4 & 5 MOTOR SYSTEM
(EXTERNAL SELECT VERSION B)**

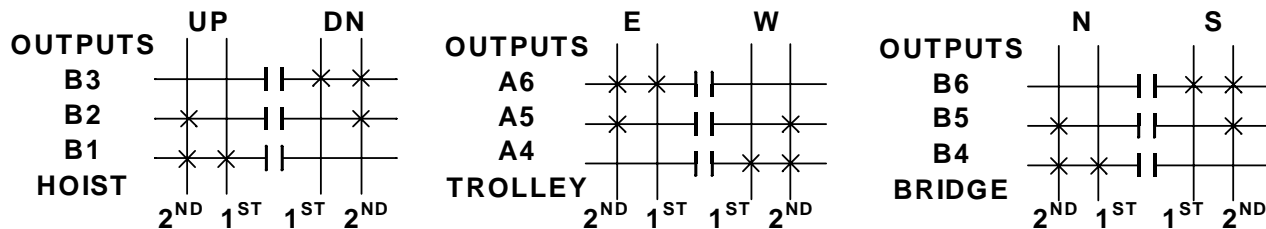

INDEPENDENT OUTPUTS

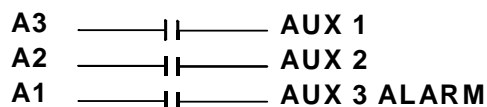

STANDARD OUTPUTS	STANDARD OUTPUTS	OPTIONAL OUTPUT BOARD OPTION #1	OPTIONAL OUTPUT BOARD OPTION #2
A1 AUX 3 (ALARM)	B1 HOIST UP	C1 SELECT 2	C1 SELECT 2
A2 AUX 2 (LATCHABLE S2-6)	B2 HOIST 2 ND SPEED	C2 SELECT 1	C2 SELECT 1
A3 AUX 1 (LATCHABLE S2-7)	B3 HOIST DOWN	C3 MULTIBOX 1	C3 AUX 4
A4 TROLLEY WEST	B4 BRIDGE NORTH	C4 MULTIBOX 2	C4 AUX 5
A5 TROLLEY 2 ND SPEED	B5 BRIDGE 2 ND SPEED	C5 MULTIBOX 3	C5 AUX 6
A6 TROLLEY EAST	B6 BRIDGE SOUTH	C6 MULTIBOX 4	C6

Transmitter and Receiver Switch Select: Switch settings Sw3-5 to Sw3-7 are defined as follows (for Optional Output Board in the Receiver Sw3-3 must be "ON" for Option #1 and "OFF" for Option #2):

TRANSMITTER SWITCH SETTINGS: Conf. Sw4-2 Sw4-1 Sw3-4
 3 ON ON ON

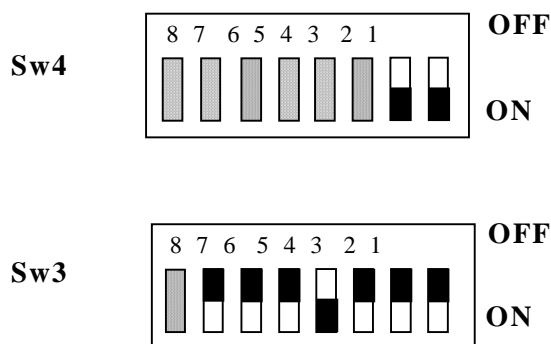

For these switch positions see the beginning of this section.

**Appendix A - 10K12/18 Pendant and SLTX
Transmitter Rrogramming (Continued)**

TABLE 1(I)

Crane Control Type Selection: 10K12 CONFIGURATION 4 WIRING DIAGRAM

STANDARD 2-SPEED 4 & 5 MOTOR SYSTEM

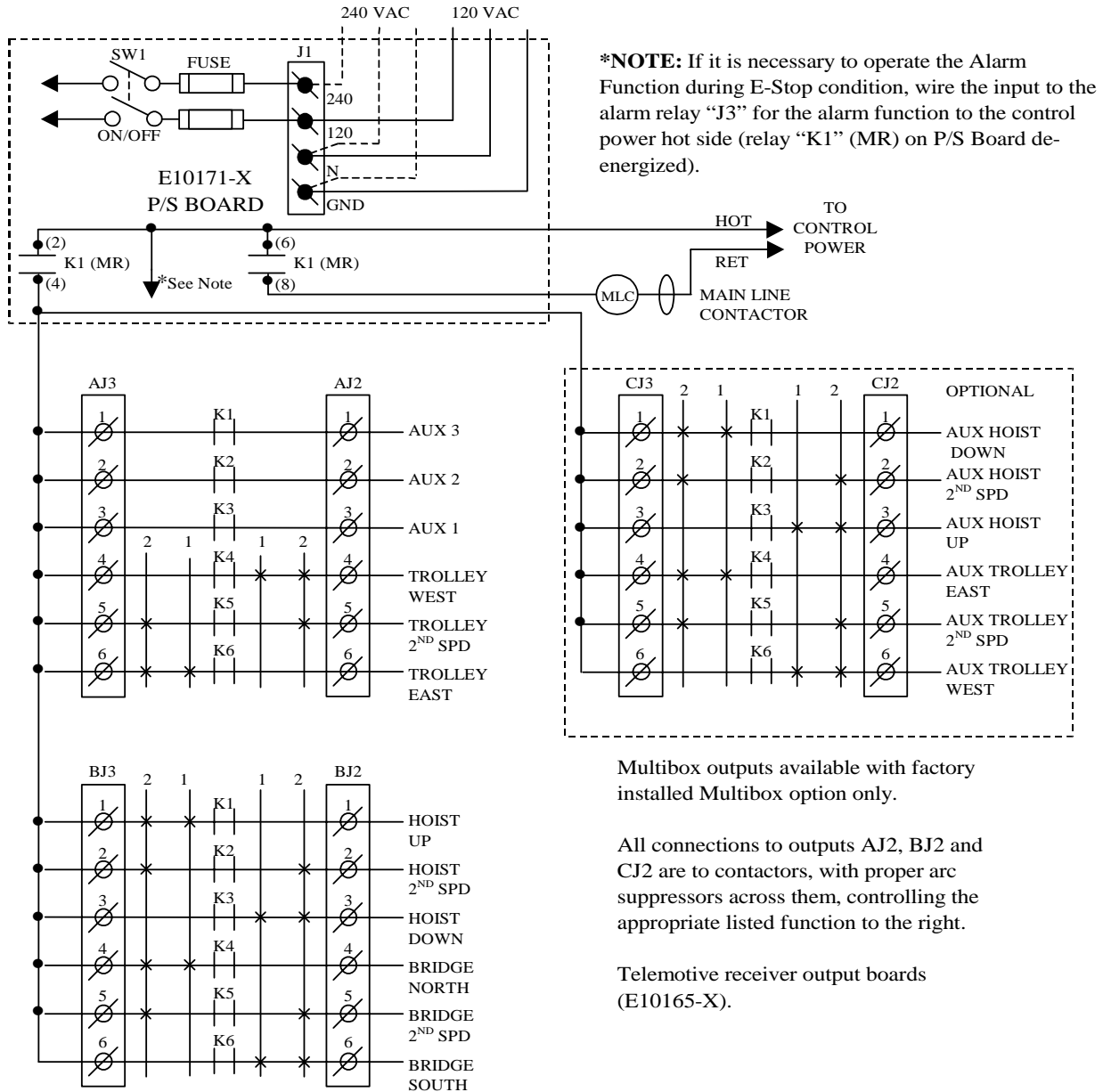

**Appendix A - 10K12/18 Pendant and SLTX
Transmitter Programming (Continued)**

TABLE 1(I)

Crane Control Type Selection: 10K12 CONFIGURATION 4 PROGRAMMING

STANDARD 2-SPEED 4 & 5 MOTOR SYSTEM

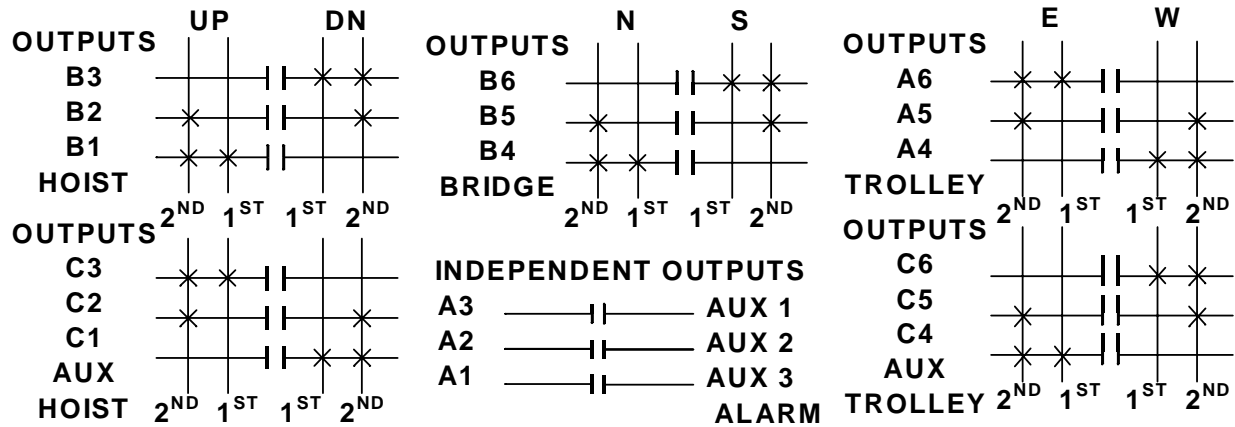

STANDARD OUTPUTS

STANDARD OUTPUTS

OPTIONAL OUTPUT BOARD OPTION #1

- | | | |
|----------------------------------|---------------------------------|--------------------------------------|
| A1 AUX 3 (ALARM) | B1 HOIST UP | C1 AUX HOIST DOWN |
| A2 AUX 2 (LATCHABLE S2-6) | B2 HOIST 2 ND SPEED | C2 AUX HOIST 2 ND SPEED |
| A3 AUX 1 (LATCHABLE S2-7) | B3 HOIST DOWN | C3 AUX HOIST UP |
| A4 TROLLEY WEST | B4 BRIDGE NORTH | C4 AUX TROLLEY EAST |
| A5 TROLLEY 2 ND SPEED | B5 BRIDGE 2 ND SPEED | C5 AUX TROLLEY 2 ND SPEED |
| A6 TROLLEY EAST | B6 BRIDGE SOUTH | C6 AUX TROLLEY WEST |

Transmitter and Receiver Switch Select: Switch settings Sw3-5 to Sw3-7 are defined as follows (for Optional Output Board in the Receiver Sw3-3 must be "ON" for Option #1):

TRANSMITTER SWITCH SETTINGS: Conf. Sw4-2 Sw4-1 Sw3-4
 4 ON OFF ON

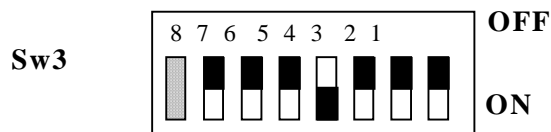
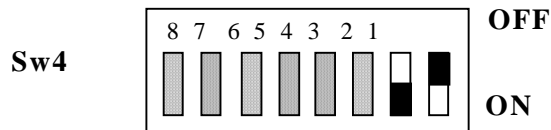

For these switch positions see the beginning of this section.

**Appendix A - 10K12/18 Pendant and SLTX
Transmitter Rrogramming (Continued)**

TABLE 1(m)

Repositioning of transmitter pushbutton switch functions for pendant only.

SW3 positions 1 through 3 can change the functional positions of the switches controlling trolley, hoist and bridge. This can be usefull to align EAST/WEST and NORTH/SOUTH. This reconfiguration does NOT affect receiver wiring.

WARNING

CHANGING THESE SWITCHES CHANGES THE FUNCTIONAL OPERATION OF THE CRANE IN RELATIONSHIP TO THE TRANSMITTER BUTTON BEING DEPRESSED. THE FUNCTIONAL OPERATION OF THE CRANE SHOULD NEVER BE CHANGED WITHOUT ALL PERSONNEL RESPONSIBLE FOR CRANE OPERATION BEING NOTIFIED PRIOR TO MODIFICATION.

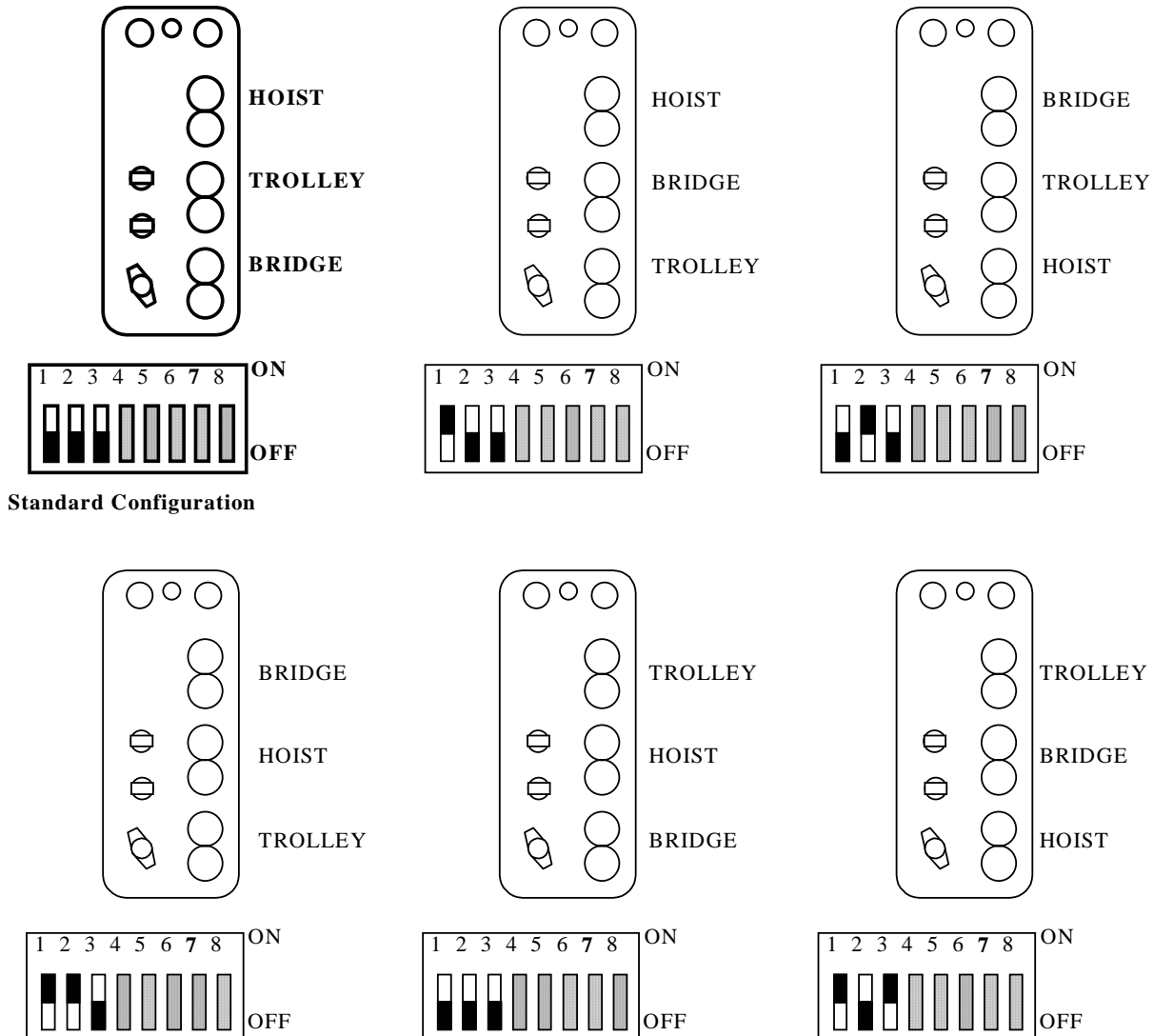

Appendix B - 10K12 2-Speed Membrane Transmitter **Programming**

NOTE: This section also contains information on Optional Output Board for Multibox and other optional outputs.

Appendix B - 10K12 2-Speed Membrane Transmitter Programming (Continued)

B-1. Transmitter Switches Sw3 and Sw4 Programming. (See Section 6-3 for physical location of transmitter switches).

B-1.1. Transmitter programming Sw3

B-1.1.1. Positions 1-3 Switch Positioning. (Standard configuration all “OFF”).

NOTE

Transmitter Sw4 positions 1-2 must be set to “OFF” (2-speed) for Switch Positioning to function.

For the 2-speed membrane transmitter the functional positions of the various buttons controlling the hoist, bridge and trolley can be moved by transmitter dip switch Sw3 also. Positions Sw3-1 through Sw3-3 control these functions. No change in receiver wiring is needed to use these functions. See [TABLE 1\(i\)](#) for switch versus button configurations.

B-1.1.2. Position 4 Time-out-timer Disable. (Normally keep turned “OFF”).

The transmitter has an approximate 15-minute time-out-timer. If the transmitter is not used for over 15 minutes it will shut down. This transmitter time-out-timer function is transmitter dip switch selectable. Sw3 position 8 disables the time-out-timer. Turning Sw3-8 “ON” disables the time-out-timer. See [TABLE 1\(h\)](#) for details.

B-1.1.3. Positions 5-7 Extended Crane Control Configurations. (Standard all “OFF” otherwise see [TABLE 1\(b\)](#) through [TABLE 1\(g\)](#)).

Extended Crane Control Options for 10K12 2-Speed Membrane Transmitter:

The 10K12 2-Speed Membrane transmitter is available with extended crane control configurations. These options are switch configurable on the transmitter microcomputer module. The eight-position dip switch Sw3 can provide all con-

figurations with a single transmitter CPU EPROM. Table 1 shows the available configurations and the transmitter switch programming needed to provide them. The standard 2-speed transmitter comes with the output configuration as shown in [TABLE 1\(a\)](#): TYPE 0 and has no extended crane control configurations. Its wiring is shown in [TABLE 1\(a\)](#): TYPE 0. **For extended crane control configurations:** See [TABLE 1\(b\)](#) through [TABLE 1\(g\)](#): TYPE 1 through TYPE 6 respectively. If a configuration listed in [TABLE 1\(b\)](#) through [TABLE 1\(g\)](#) is preferred over the standard configuration, please reprogram transmitter switch Sw3.

B-1.1.4. Position 8 no function. (Keep turned “OFF”).

B-1.2. Transmitter programming Sw4

B-1.2.1. Positions 1-2 Mode Enable. (See Membrane Transmitter Mode Select page 6-5). (All 2-speed configurations all “OFF”).

Mode 0, Sw4 1 turned “OFF” and Sw4 2 turned “OFF”. From the factory the standard membrane transmitter is the 2-speed configured this way. This mode in the membrane transmitter is for **all 2-speed** applications. If the membrane transmitter has a 2-speed keypad Sw4 must be set to all “OFF” positions.

(The following three single speed modes are listed for replacement purposes only.) Mode 1, Sw4 1 turned “ON” and Sw4 2 turned “OFF”. This configuration gives four motor single speed with four auxiliaries. This configuration uses the single speed keypad with two auxiliaries labeled P1 and P2.

Mode 2, Sw4 1 turned “OFF” and Sw4 2 turned “ON”. This configuration gives four motor single speed with four auxiliaries. This configuration uses the single speed keypad with four auxiliaries labeled Aux 1 through Aux 4.

Mode 3, Sw4 1 turned “ON” and Sw4 2 turned “ON”. Allows for 12 independent on/off functions (relays) per transmitter button pushed.

**Appendix B - 10K12 2-Speed Membrane Transmitter
Programming (Continued)**

B-2. Replacement Transmitter EPROM's

All 2-speed membrane transmitters with M/C Module E10678-X use CPU EPROM part number FW2836-0.

B-3. Multibox and Optional Output Board:

WARNING

IF YOUR UNIT WAS NOT ORDERED WITH MULTIBOX DO NOT ATTEMPT TO PROGRAM MULTIBOX IN THE FIELD. TELEMOTIVE MUST COORDINATE ACCESS CODE ASSIGNMENTS WITH THE TRANSMITTERS PRIOR TO ENABLING MULTIBOX. PLEASE CONTACT TELEMOTIVE IF YOU NEED TO ADD MULTIBOX. FAILURE TO DO SO CAN BE A SERIOUS SAFETY HAZARD.

If Multibox is used (Receiver switch Sw3-3 is "ON" and the Optional Output Board is installed in the receiver). The outputs are as follows:

- C1-C2 Defined per type
- C3 MULTIBOX 1
- C4 MULTIBOX 2
- C5 MULTIBOX 3
- C6 MULTIBOX 4

B-4. Latching of Auxiliary Relays

Certain auxiliary relays can be set to latch (be toggled on and off) by setting dip switch S2 positions 6-8 on the **Receiver** CPU Board. If an Aux function is latchable it is noted in the programming diagram by the following note (LATCHABLE S2-#) where # is the switch position 6-8 that must be turned on for the latching function.

B-5. TABLE 1(a) through TABLE 1(g) Wiring and Programming Diagrams

The following tables give various extended crane configurations. Functional terms like Trolley South and Hoist Up match standard transmitter labeling from the factory. The following legend is used in these diagrams:

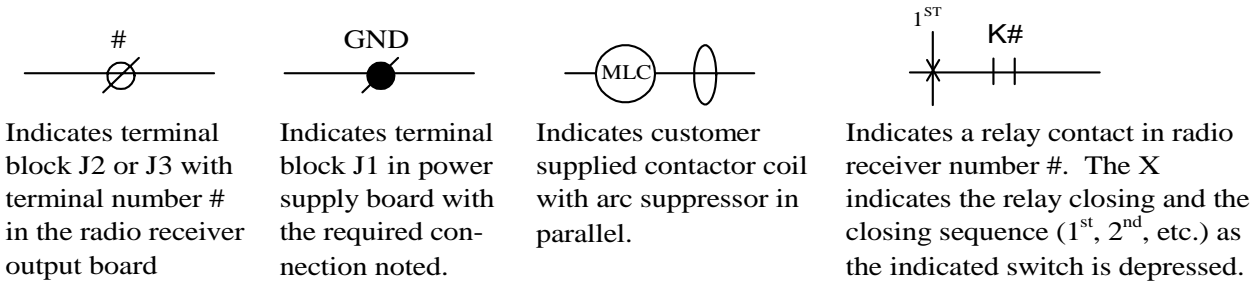

Appendix B - 10K12 2-Speed Membrane Transmitter Programming (Continued)

In the following wiring diagrams the relay outputs AJ2, BJ2 and CJ2 have listed to the right of the output terminal the appropriate motor function they control, i.e., trolley, hoist etc. Proper installation requires that this output be wired to a contactor controlling that function and that the contactor has the proper arc suppressor across it. The relays on these output boards are rated at 16 amps and fused at 10 amps unless otherwise noted.

B-6. Optional 110 Volt Wiring

Power supply wiring is accomplished through connector J1 on the power supply board. The connections labeled 240, 120, N and GND are wired to the appropriate supply connections per the wiring diagrams. An extra connection 120 is provided for 120 Volt applications only for jumpering to Pins 2 and 6 of the Master Relay (MR) K1 on the power supply board. The unit may optionally be wired as in [Figure B-1](#). [Figure B-2](#) shows the wiring layout. All other wiring is accomplished per the attached tables.

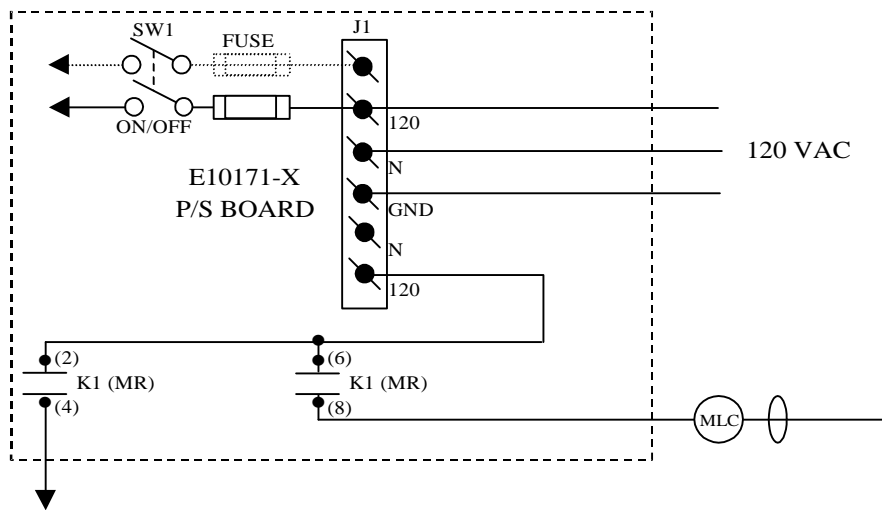

Figure B-1. Optional 120 VAC Wiring Diagram

**Appendix B - 10K12 2-Speed Membrane Transmitter
Programming (Continued)**

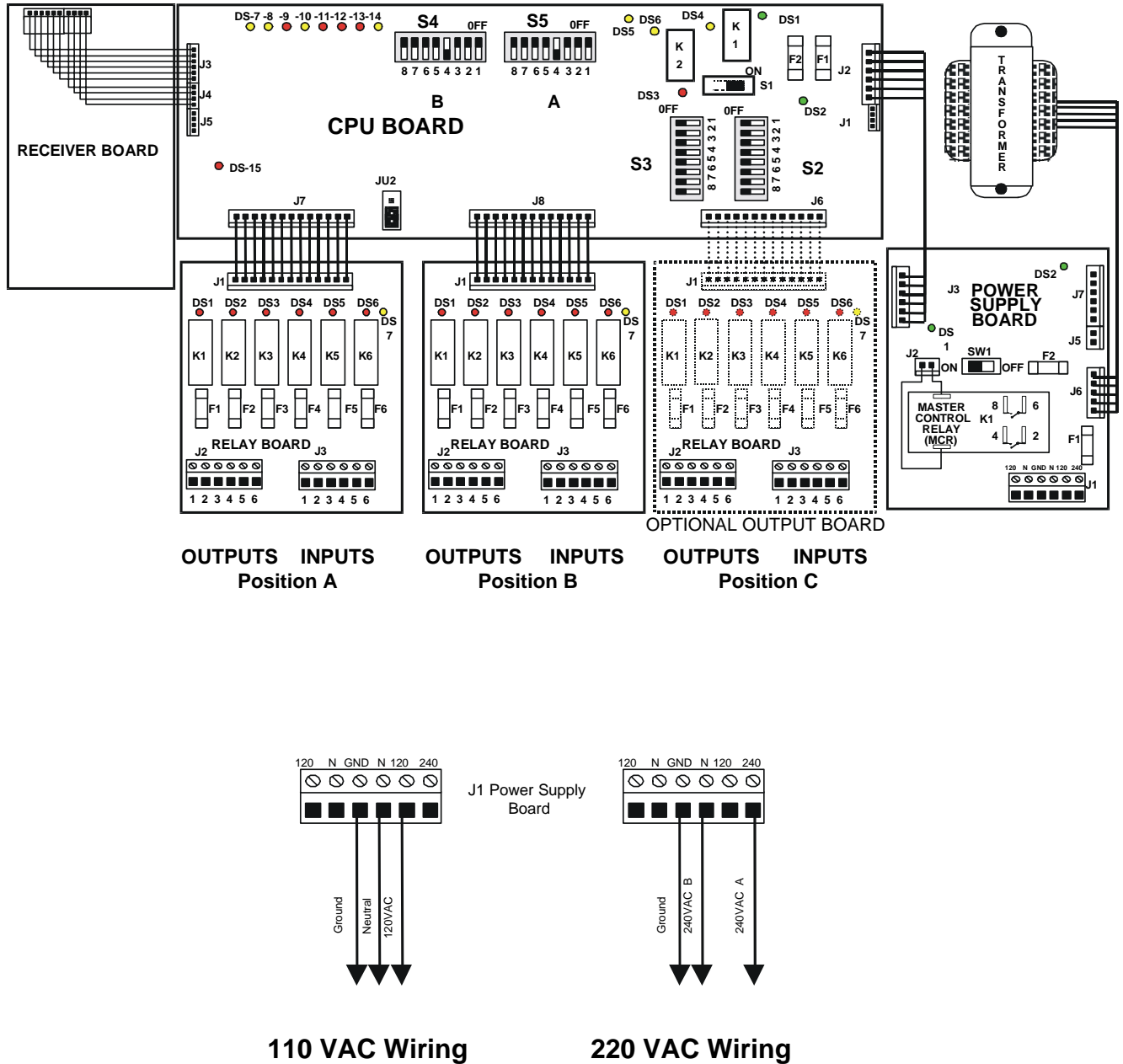

Figure B-2. 10K12 Wiring Layout

B-7. Crane Control Type Selection

The crane control type selection information is provided in [TABLE 1\(a\)](#) through [TABLE 1\(i\)](#). Each table defines a specific configuration and provides a wiring diagram, a programming diagram, and transmitter and receiver switch settings. The table for each configuration is provided on facing pages so that all information is easily accessible.

**Appendix B - 10K12 2-Speed Membrane Transmitter
Programming (Continued)**

TABLE 1(a)

Crane Control Type Selection: 10K12 TYPE 0 WIRING DIAGRAM

STANDARD CONFIGURATION: ALL MOTIONS
(HOIST, TROLLEY and BRIDGE)

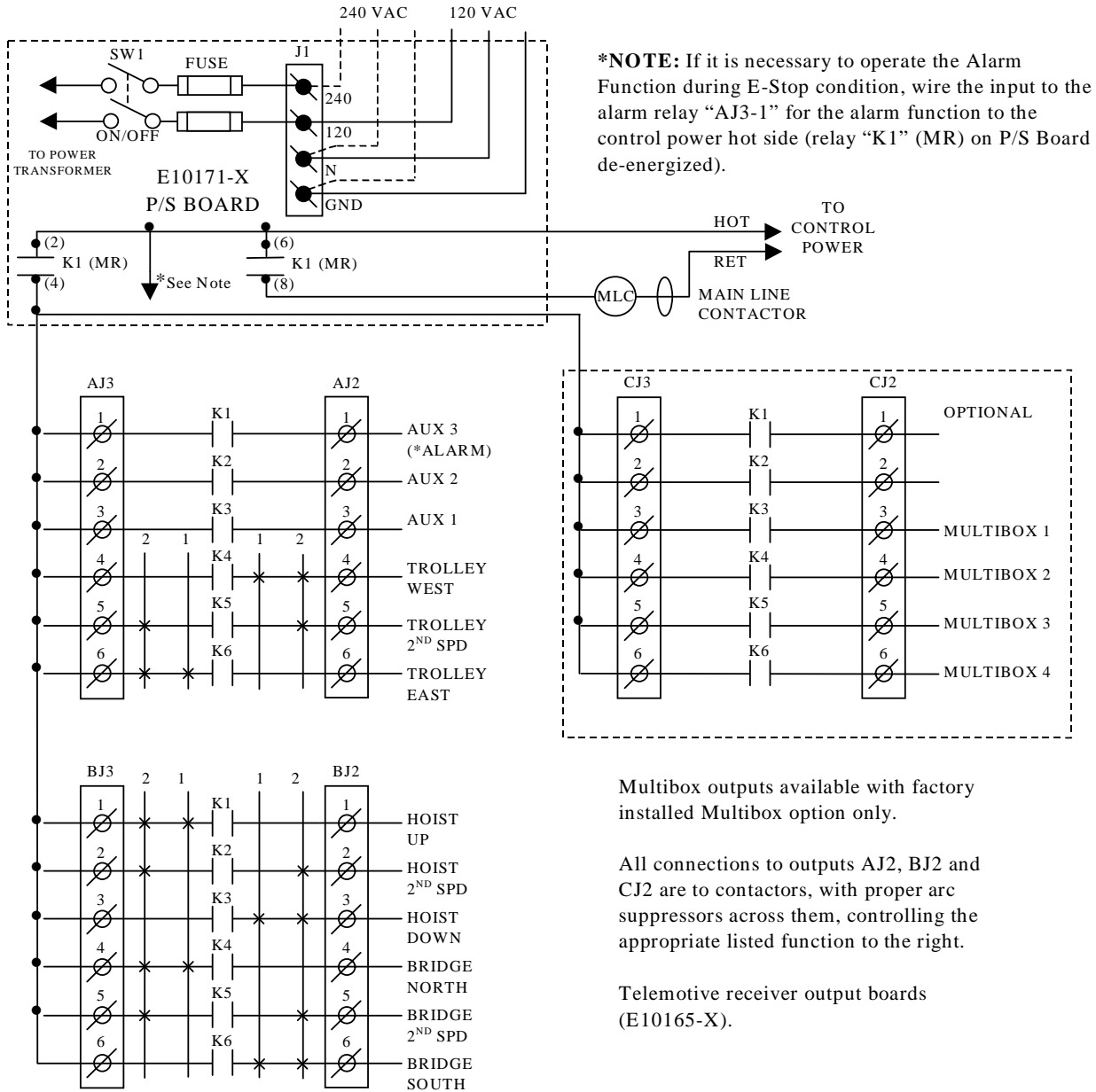

***NOTE:** If it is necessary to operate the Alarm Function during E-Stop condition, wire the input to the alarm relay "AJ3-1" for the alarm function to the control power hot side (relay "K1" (MR) on P/S Board de-energized).

Multibox outputs available with factory installed Multibox option only.

All connections to outputs AJ2, BJ2 and CJ2 are to contactors, with proper arc suppressors across them, controlling the appropriate listed function to the right.

Telemotive receiver output boards (E10165-X).

**Appendix B - 10K12 2-Speed Membrane Transmitter
Programming (Continued)**

TABLE 1(a)

Crane Control Type Selection: 10K12 2-Speed TYPE 0 PROGRAMMING

STANDARD CONFIGURATION: ALL MOTIONS
(HOIST, TROLLEY and BRIDGE)

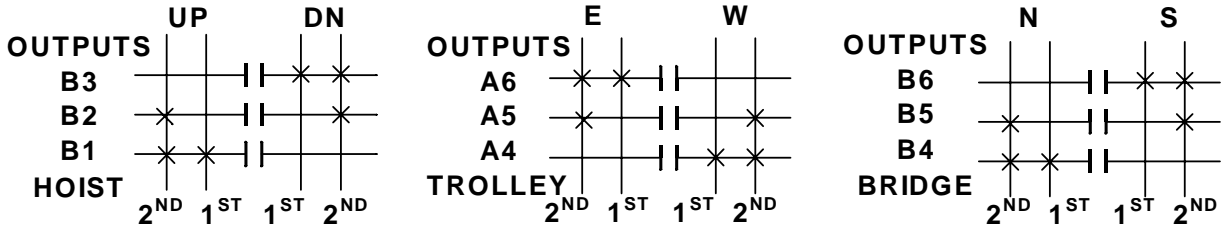

INDEPENDENT OUTPUTS

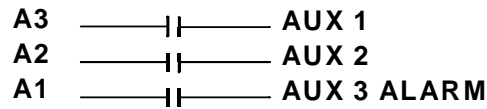

STANDARD OUTPUTS	STANDARD OUTPUTS	OPTIONAL OUTPUT BOARD OPTION #1
A1 AUX 3 (ALARM)	B1 HOIST UP	C1
A2 AUX 2 (LATCHABLE S2-6)	B2 HOIST 2 ND SPEED	C2
A3 AUX 1 (LATCHABLE S2-7)	B3 HOIST DOWN	C3 MULTIBOX 1
A4 TROLLEY WEST	B4 BRIDGE NORTH	C4 MULTIBOX 2
A5 TROLLEY 2 ND SPEED	B5 BRIDGE 2 ND SPEED	C5 MULTIBOX 3
A6 TROLLEY EAST	B6 BRIDGE SOUTH	C6 MULTIBOX 4

Membrane Transmitter and Receiver Switch Select:

Switch settings Sw3-5 to Sw3-7 are defined as follows (for Optional Output Board in the Receiver Sw3-3 must be "ON" for Option #1):

TRANSMITTER SWITCH SETTINGS:	<u>TYPE</u>	<u>Sw3-5</u>	<u>Sw3-6</u>	<u>Sw3-7</u>
	0	OFF	OFF	OFF

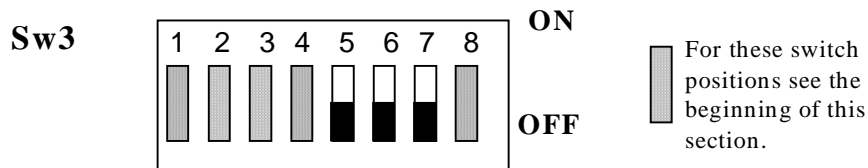

NOTE: Transmitter Sw4 positions 1 and 2 must be set to "OFF" for Sw3 to function.

**Appendix B - 10K12 2-Speed Membrane Transmitter
Programming (Continued)**

TABLE 1(b)

Crane Control Type Selection: 10K12 TYPE 1 WIRING DIAGRAM

2-SPEED with DIRECTIONAL CONTROL: ALL MOTIONS

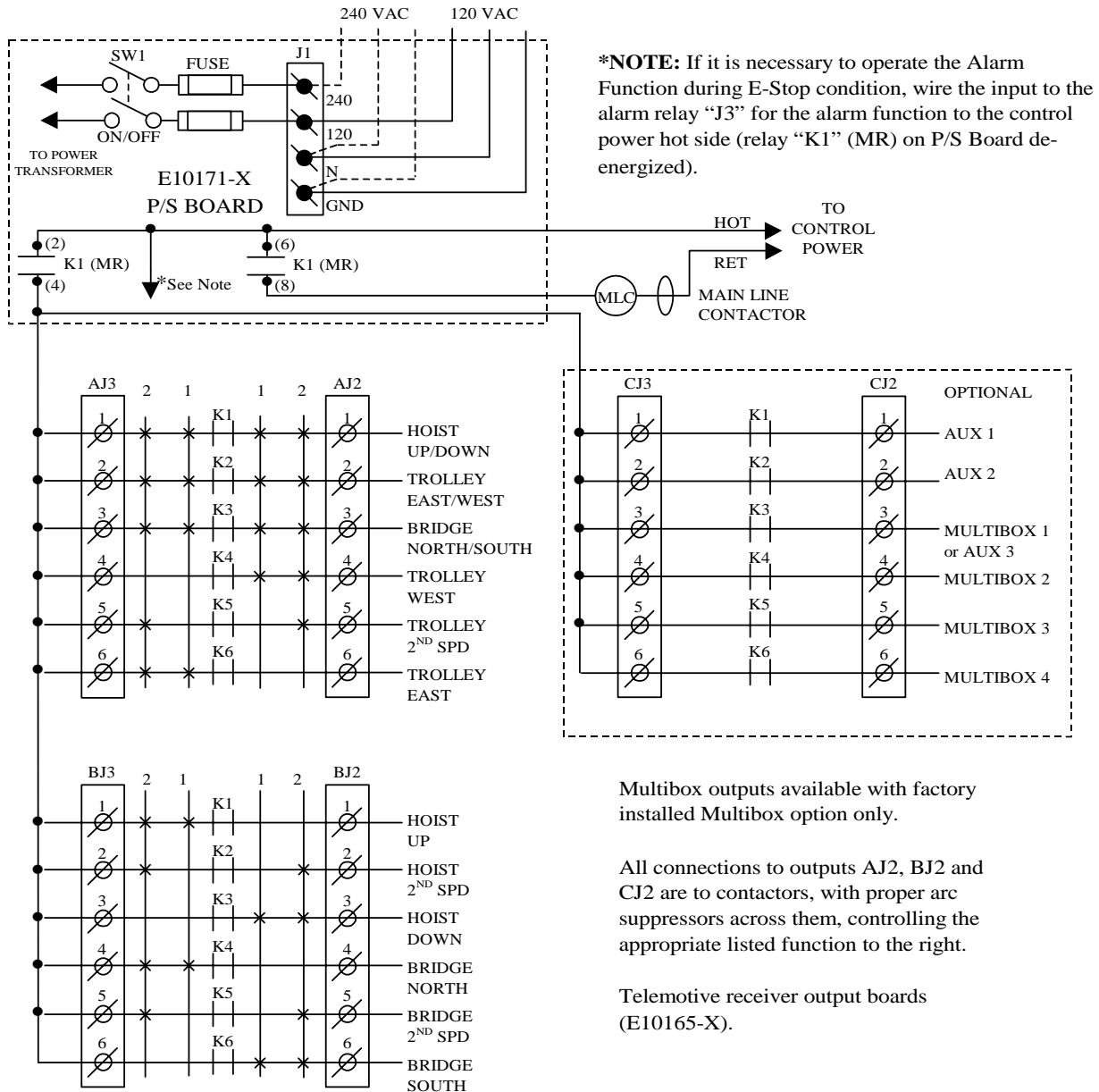

**Appendix B - 10K12 2-Speed Membrane Transmitter
Programming (Continued)**

TABLE 1(b)

Crane Control Type Selection: 10K12 2-Speed TYPE 1 PROGRAMMING

2-SPEED with DIRECTIONAL CONTROL: ALL MOTIONS

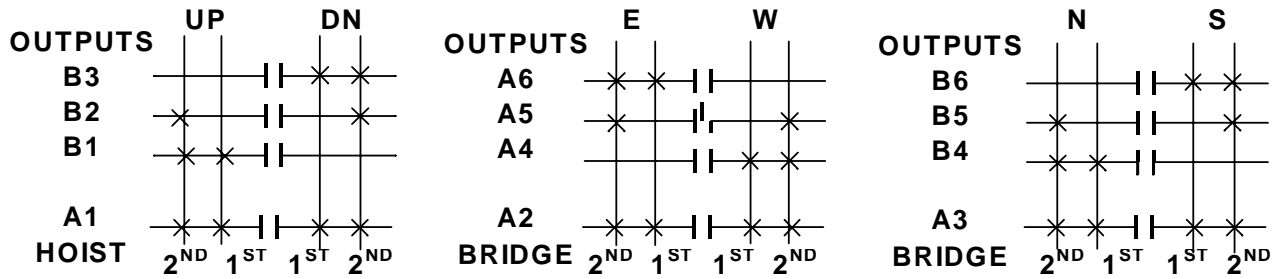

STANDARD OUTPUTS	STANDARD OUTPUTS	OPTIONAL OUTPUT BOARD OPTION #1	OPTIONAL OUTPUT BOARD OPTION #2
A1 HOIST UP/DOWN	B1 HOIST UP	C1 AUX 1	C1 AUX 1
A2 TROLLEY EAST/WEST	B2 HOIST 2 ND SPEED	C2 AUX 3	C2 AUX 2
A3 BRIDGE NORTH/SOUTH	B3 HOIST DOWN	C3 MULTIBOX 1	C3 AUX 3
A4 TROLLEY WEST	B4 BRIDGE NORTH	C4 MULTIBOX 2	C4
A5 TROLLEY 2 ND SPEED	B5 BRIDGE 2 ND SPEED	C5 MULTIBOX 3	C5
A6 TROLLEY EAST	B6 BRIDGE SOUTH	C6 MULTIBOX 4	C6

Membrane Transmitter and Receiver Switch Select:
Switch settings **Sw3-5** to **Sw3-7** are defined as follows (for Optional Output Board in the Receiver **Sw3-3** must be "ON" for Option #1 and "OFF" for Option #2).

TRANSMITTER SWITCH SETTINGS:

<u>Type</u>	<u>Sw3-5</u>	<u>Sw3-6</u>	<u>Sw3-7</u>
1	ON	OFF	OFF

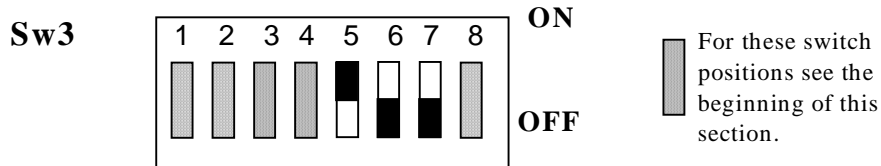

NOTE: Transmitter Sw4 positions 1 and 2 must be set to "OFF" for Sw3 to function.

**Appendix B - 10K12 2-Speed Membrane Transmitter
Programming (Continued)**

TABLE 1(c)

Crane Control Type Selection: 10K12 TYPE 2 WIRING DIAGRAM

2-SPEED, 2-WINDINGS: ALL MOTIONS

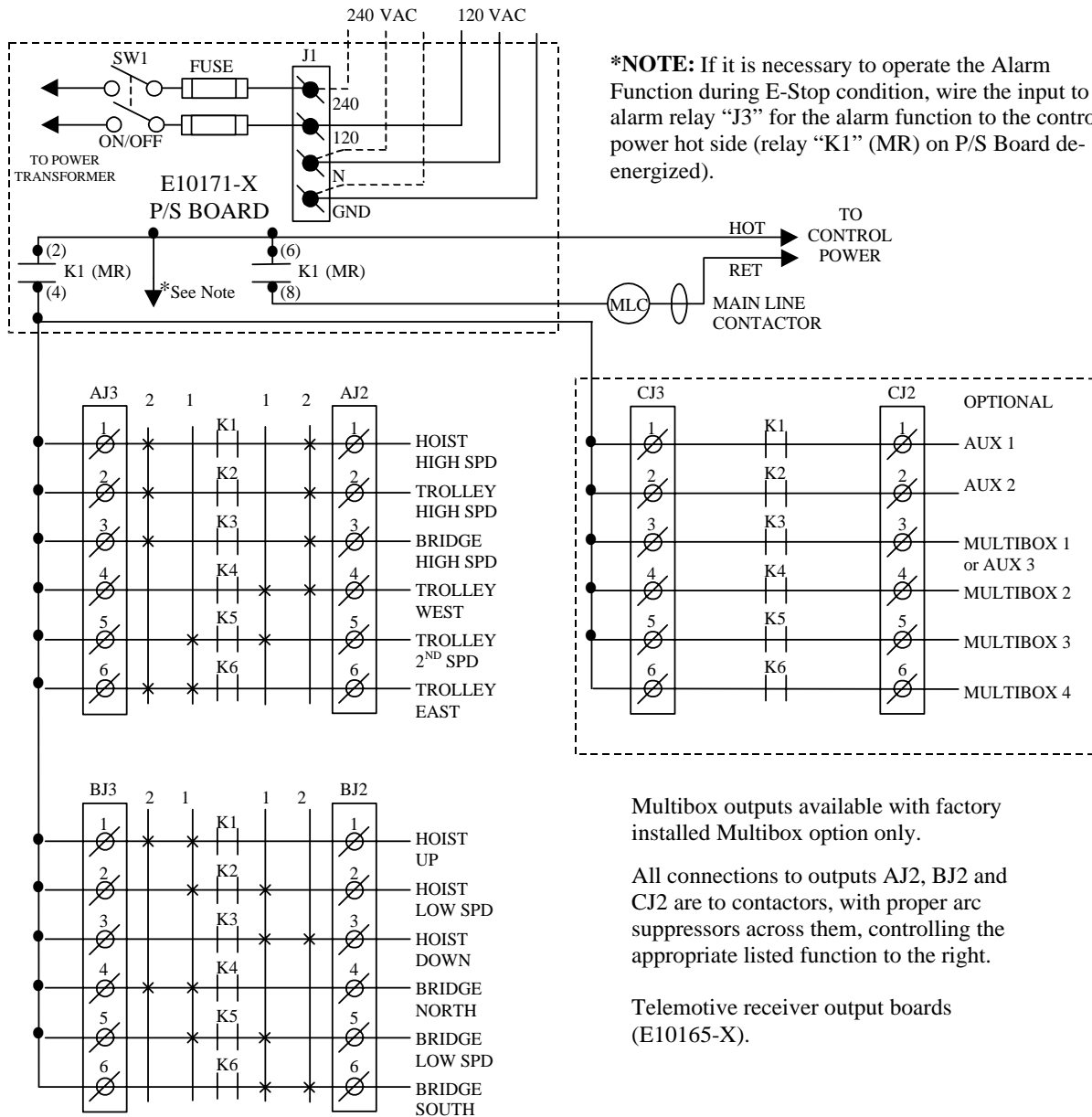

*Appendix B - 10K12 2-Speed Membrane Transmitter
Programming (Continued)*

TABLE 1(c)

Crane Control Type Selection: 10K12 2-Speed TYPE 2 PROGRAMMING

2-SPEED, 2-WINDINGS: ALL MOTIONS

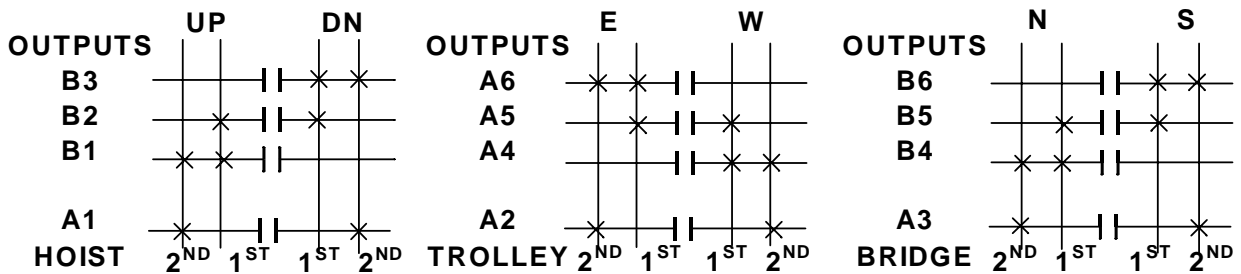

STANDARD OUTPUTS	STANDARD OUTPUTS	OPTIONAL OUTPUT BOARD OPTION #1	OPTIONAL OUTPUT BOARD OPTION #2
A1 HOIST 2 ND SPEED	B1 HOIST UP	C1 AUX 1	C1 AUX 1
A2 TROLLEY 2 ND SPEED	B2 HOIST 1 ST SPEED	C2 AUX 2	C2 AUX 2
A3 BRIDGE 2 ND SPEED	B3 HOIST DOWN	C3 MULTIBOX 1	C3 AUX 3
A4 TROLLEY WEST	B4 BRIDGE NORTH	C4 MULTIBOX 2	C4
A5 TROLLEY 1 ST SPEED	B5 BRIDGE 1 ST SPEED	C5 MULTIBOX 3	C5
A6 TROLLEY EAST	B6 BRIDGE SOUTH	C6 MULTIBOX 4	C6

Membrane Transmitter and Receiver Switch Select:

Switch settings Sw3-5 to Sw3-7 are defined as follows (for Optional Output Board in the Receiver Sw3-3 must be “ON” for Option #1 and “OFF” for Option #2):

TRANSMITTER SWITCH SETTINGS:

Type	Sw3-5	Sw3-6	Sw3-7
2	OFF	ON	OFF

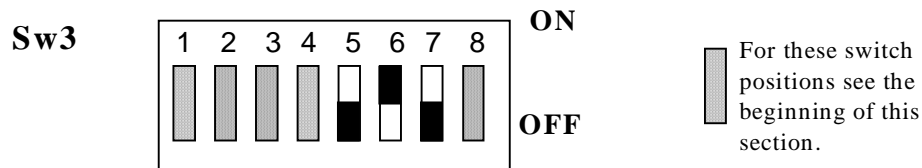

NOTE: Transmitter Sw4 positions 1 and 2 must be set to “OFF” for Sw3 to function.

**Appendix B - 10K12 2-Speed Membrane Transmitter
Programming (Continued)**

TABLE 1(d)

Crane Control Type Selection: 10K12 TYPE 3 WIRING DIAGRAM

ACCO CONTROLS: ALL MOTIONS

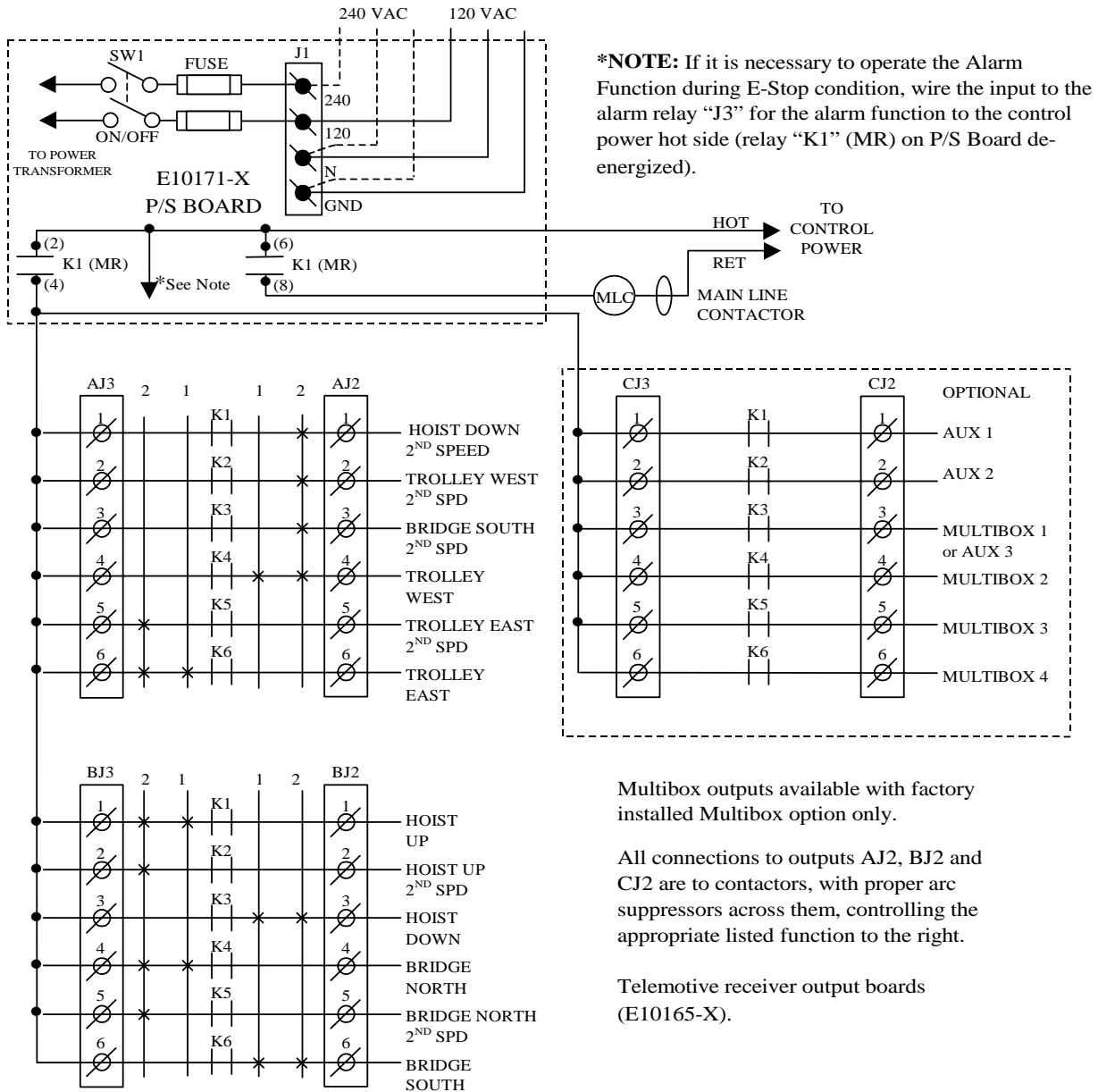

Multibox outputs available with factory installed Multibox option only.

All connections to outputs AJ2, BJ2 and CJ2 are to contactors, with proper arc suppressors across them, controlling the appropriate listed function to the right.

Telemotive receiver output boards (E10165-X).

*Appendix B - 10K12 2-Speed Membrane Transmitter
Programming (Continued)*

TABLE 1(d)

Crane Control Type Selection: 10K12 2-Speed TYPE 3 PROGRAMMING

ACCO CONTROLS: ALL MOTIONS

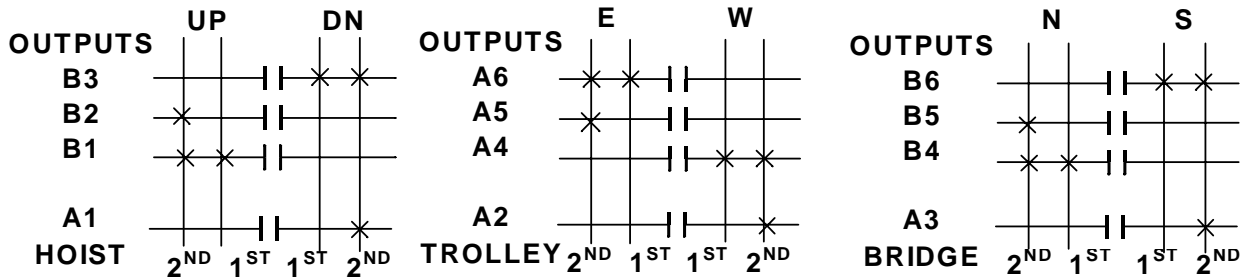

STANDARD OUTPUTS	STANDARD OUTPUTS	OPTIONAL OUTPUT BOARD OPTION #1	OPTIONAL OUTPUT BOARD OPTION #2
A1 HOIST DOWN 2 ND SPEED	B1 HOIST UP	C1 AUX 1	C1 AUX 1
A2 TROLLEY WEST 2 ND SPEED	B2 HOIST UP 2 ND SPEED	C2 AUX 2	C2 AUX 2
A3 BRIDGE SOUTH 2 ND SPEED	B3 HOIST DOWN	C3 MULTIBOX 1	C3 AUX 3
A4 TROLLEY WEST	B4 BRIDGE NORTH	C4 MULTIBOX 2	C4
A5 TROLLEY EAST 2 ND SPEED	B5 BRIDGE NORTH 2 ND SPEED	C5 MULTIBOX 3	C5
A6 TROLLEY EAST	B6 BRIDGE SOUTH	C6 MULTIBOX 4	C6

Membrane Transmitter and Receiver Switch Select:

Switch settings **Sw3-5** to **Sw3-7** are defined as follows (for Optional Output Board in the Receiver **Sw3-3** must be "ON" for Option #1 and "OFF" for Option #2):

TRANSMITTER SWITCH SETTINGS: Type Sw3-5 Sw3-6 Sw3-7
 3 ON ON OFF

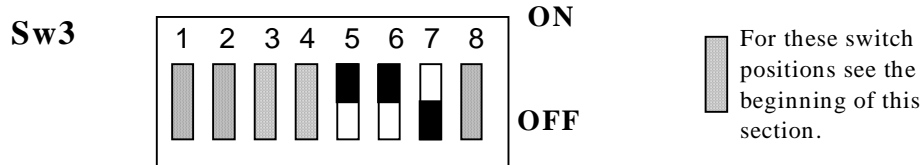

NOTE: Transmitter Sw4 positions 1 and 2 must be set to "OFF" for Sw3 to function.

**Appendix B - 10K12 2-Speed Membrane Transmitter
Programming (Continued)**

TABLE 1(e)

Crane Control Type Selection: 10K12 TYPE 4 WIRING DIAGRAM

**P&H: 2-SPEED, 2-WINDINGS for HOIST and TROLLEY:
STANDARD BRIDGE**

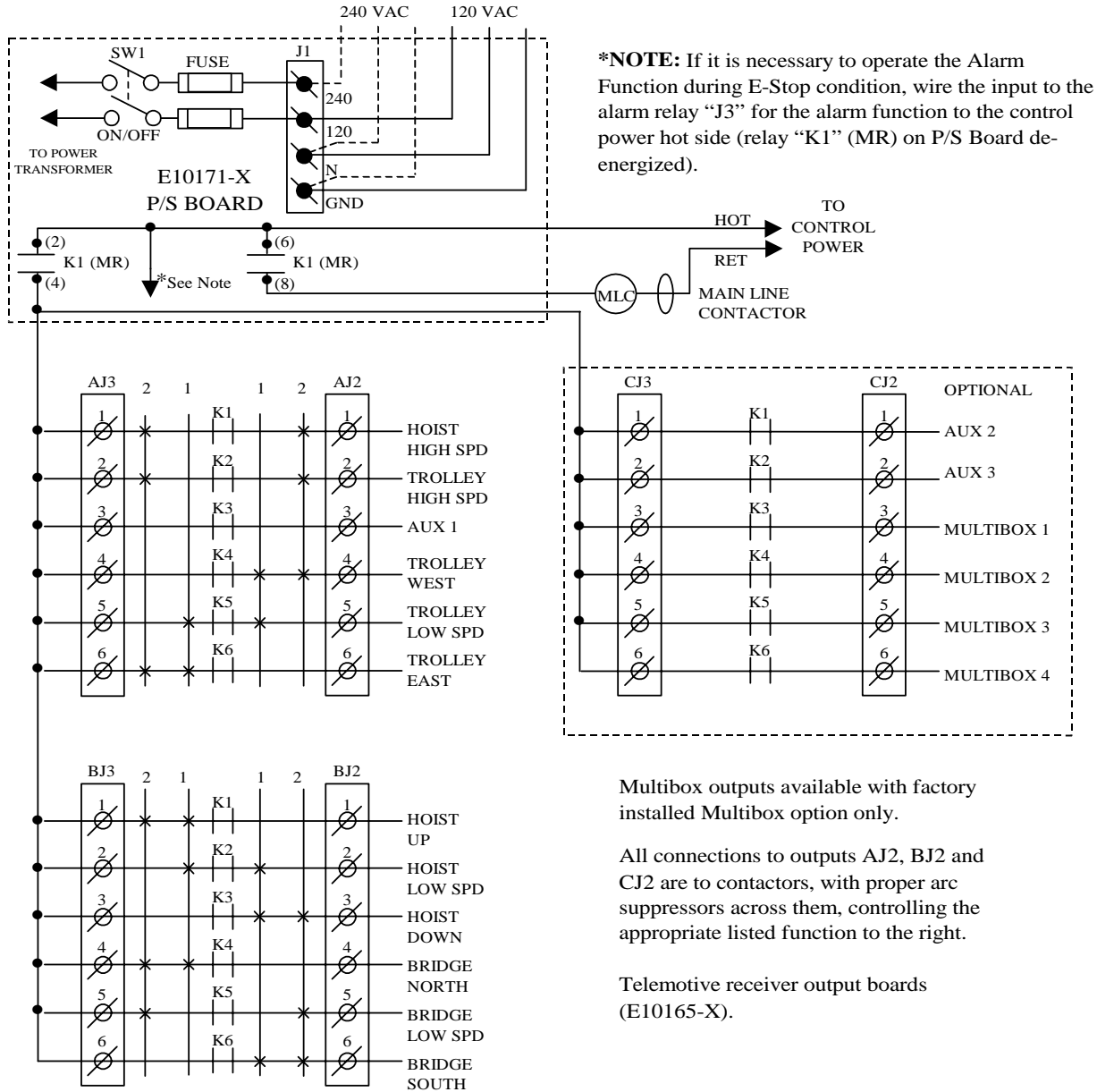

Multibox outputs available with factory installed Multibox option only.

All connections to outputs AJ2, BJ2 and CJ2 are to contactors, with proper arc suppressors across them, controlling the appropriate listed function to the right.

Telemotive receiver output boards (E10165-X).

**Appendix B - 10K12 2-Speed Membrane Transmitter
Programming (Continued)**

TABLE 1(e)

Crane Control Type Selection: 10K12 2-Speed TYPE 4 PROGRAMMING

**P&H: 2-SPEED, 2-WINDINGS for HOIST and TROLLEY:
STANDARD BRIDGE**

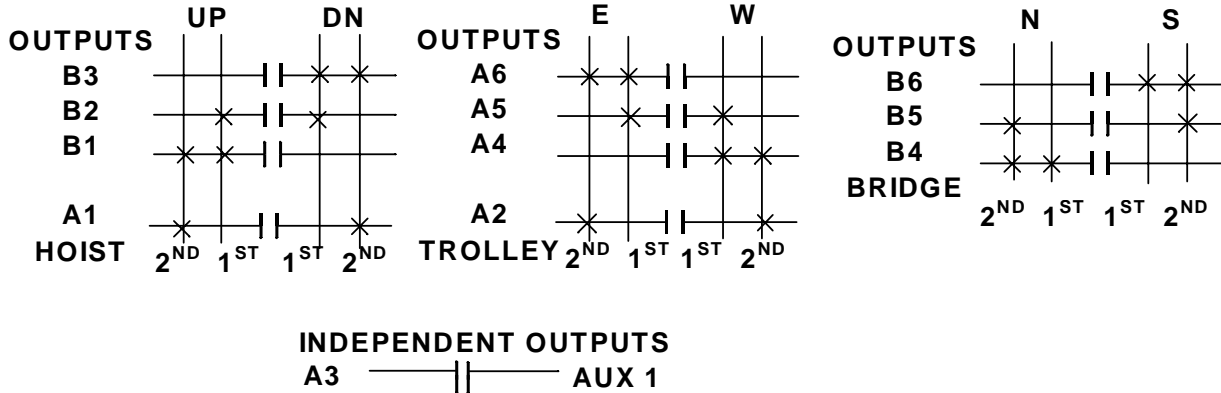

STANDARD OUTPUTS	STANDARD OUTPUTS	OPTIONAL OUTPUT BOARD OPTION #1	OPTIONAL OUTPUT BOARD OPTION #2
A1 HOIST 2 ND SPEED	B1 HOIST UP	C1 AUX 2	C1 AUX 2
A2 TROLLEY 2 ND SPEED	B2 HOIST 1 ST SPEED	C2 AUX 3	C2 AUX 3
A3 AUX 1 (LATCHABLE S2-7)	B3 HOIST DOWN	C3 MULTIBOX 1	C3
A4 TROLLEY WEST	B4 BRIDGE NORTH	C4 MULTIBOX 2	C4
A5 TROLLEY 1 ST SPEED	B5 BRIDGE 2 ND SPEED	C5 MULTIBOX 3	C5
A6 TROLLEY EAST	B6 BRIDGE SOUTH	C6 MULTIBOX 4	C6

Membrane Transmitter and Receiver Switch Select:
Switch settings **Sw3-5** to **Sw3-7** are defined as follows (for Optional Output Board in the Receiver **Sw3-3** must be "ON" for Option #1 and "OFF" for Option #2):

TRANSMITTER SWITCH SETTINGS:

<u>Type</u>	<u>Sw3-5</u>	<u>Sw3-6</u>	<u>Sw3-7</u>
4	OFF	OFF	ON

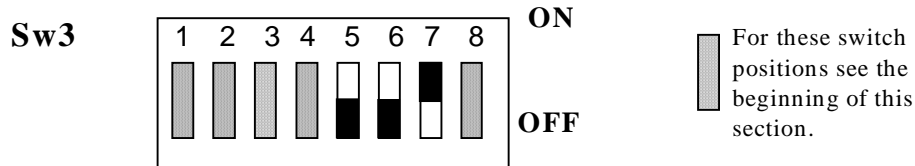

NOTE: Transmitter Sw4 positions 1 and 2 must be set to "OFF" for Sw3 to function.

**Appendix B - 10K12 2-Speed Membrane Transmitter
Programming (Continued)**

TABLE 1(f)

Crane Control Type Selection: 10K12 TYPE 5 WIRING DIAGRAM

**P&H: 2-SPEED, 2-WINDINGS for HOIST:
STANDARD TROLLEY and BRIDGE**

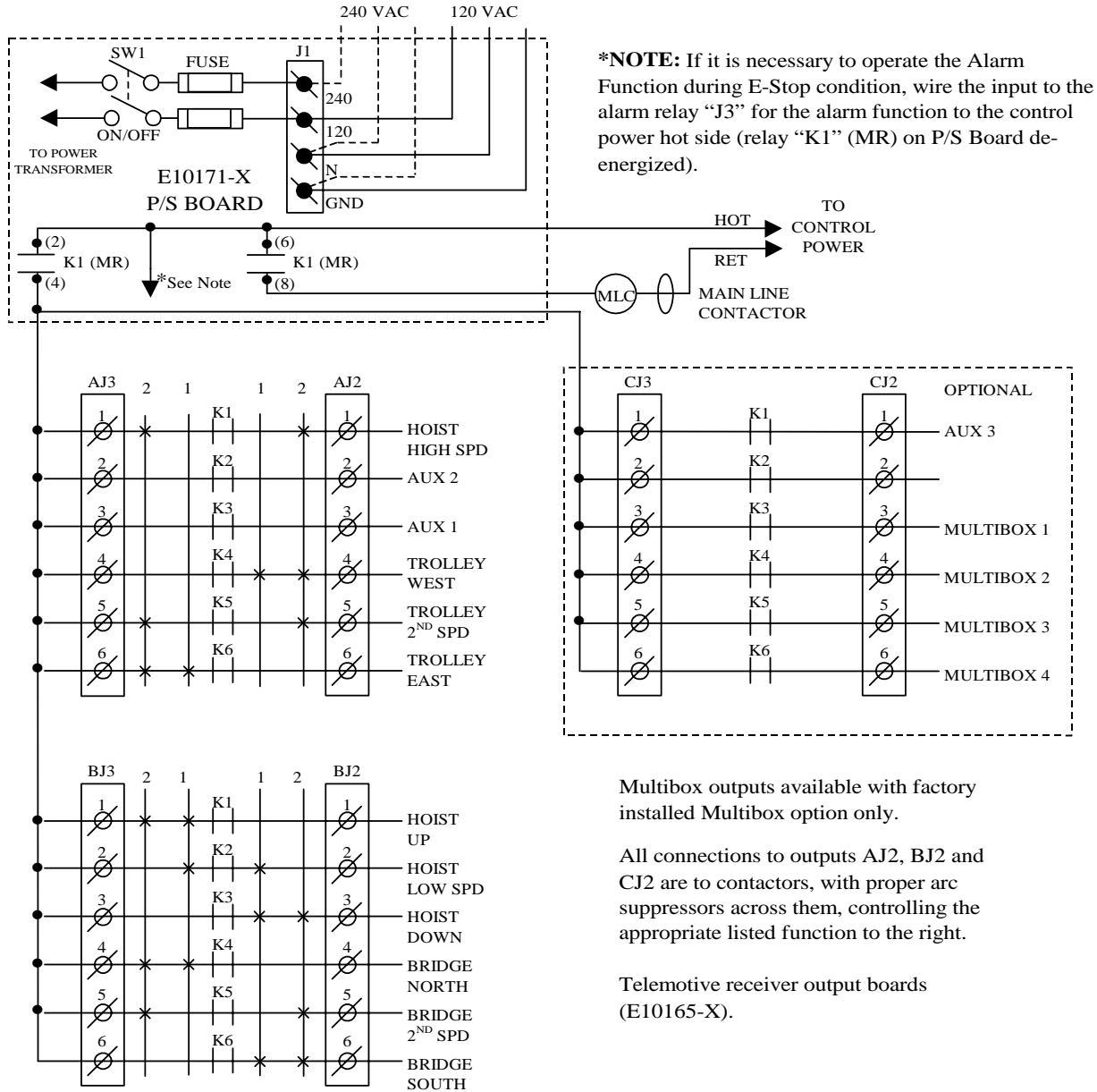

Multibox outputs available with factory installed Multibox option only.

All connections to outputs AJ2, BJ2 and CJ2 are to contactors, with proper arc suppressors across them, controlling the appropriate listed function to the right.

Telemotive receiver output boards (E10165-X).

**Appendix B - 10K12 2-Speed Membrane Transmitter
Programming (Continued)**

TABLE 1(f)

Crane Control Type Selection: 10K12 2-Speed TYPE 5 PROGRAMMING

**P&H: 2-SPEED, 2-WINDINGS for HOIST:
STANDARD TROLLEY and BRIDGE**

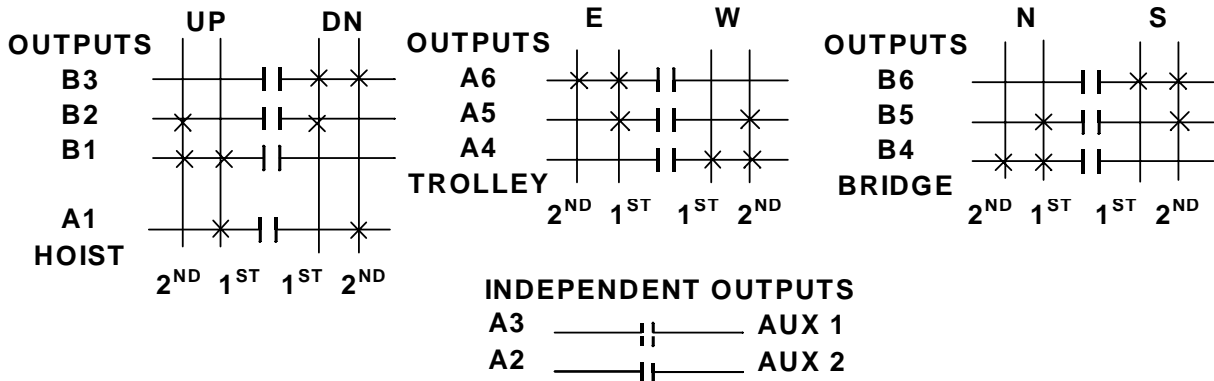

STANDARD OUTPUTS	STANDARD OUTPUTS	OPTIONAL OUTPUT BOARD OPTION #1	OPTIONAL OUTPUT BOARD OPTION #2
A1 HOIST 2 ND SPEED	B1 HOIST UP	C1 AUX 3	C1 AUX 3
A2 AUX 2 (LATCHABLE S2-6)	B2 HOIST 1 ST SPEED	C2	C2
A3 AUX 1 (LATCHABLE S2-7)	B3 HOIST DOWN	C3 MULTIBOX 1	C3
A4 TROLLEY WEST	B4 BRIDGE NORTH	C4 MULTIBOX 2	C4
A5 TROLLEY 2 ND SPEED	B5 BRIDGE 2 ND SPEED	C5 MULTIBOX 3	C5
A6 TROLLEY EAST	B6 BRIDGE SOUTH	C6 MULTIBOX 4	C6

Membrane Transmitter and Receiver Switch Select:

Switch settings **Sw3-5** to **Sw3-7** are defined as follows (for Optional Output Board in the Receiver **Sw3-3** must be "ON" for Option #1 and "OFF" for Option #2):

TRANSMITTER SWITCH SETTINGS:

<u>Type</u>	<u>Sw3-5</u>	<u>Sw3-6</u>	<u>Sw3-7</u>
5	ON	OFF	ON

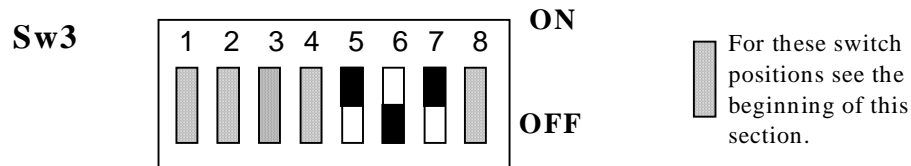

NOTE: Transmitter Sw4 positions 1 and 2 must be set to "OFF" for Sw3 to function.

**Appendix B - 10K12 2-Speed Membrane Transmitter
Programming (Continued)**

TABLE 1(g)

Crane Control Type Selection: 10K12 TYPE 6 WIRING DIAGRAM

**DEMAG: 2-SPEED, 2-WINDINGS for HOIST:
STANDARD TROLLEY and BRIDGE**

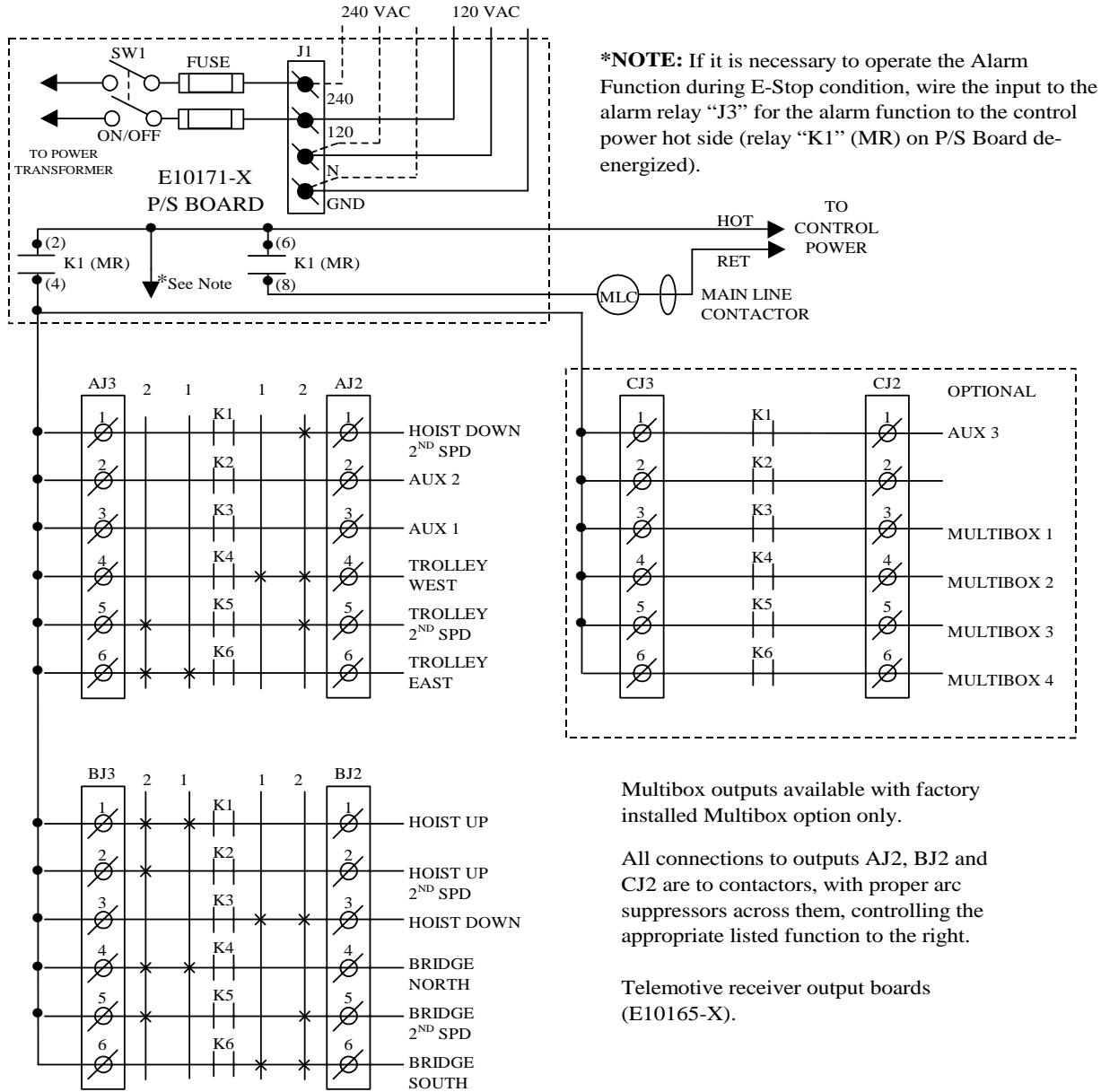

**Appendix B - 10K12 2-Speed Membrane Transmitter
Programming (Continued)**

TABLE 1(g)

Crane Control Type Selection: 10K12 TYPE 6 PROGRAMMING

**DEMAG: 2-SPEED, 2-WINDINGS for HOIST:
STANDARD TROLLEY and BRIDGE**

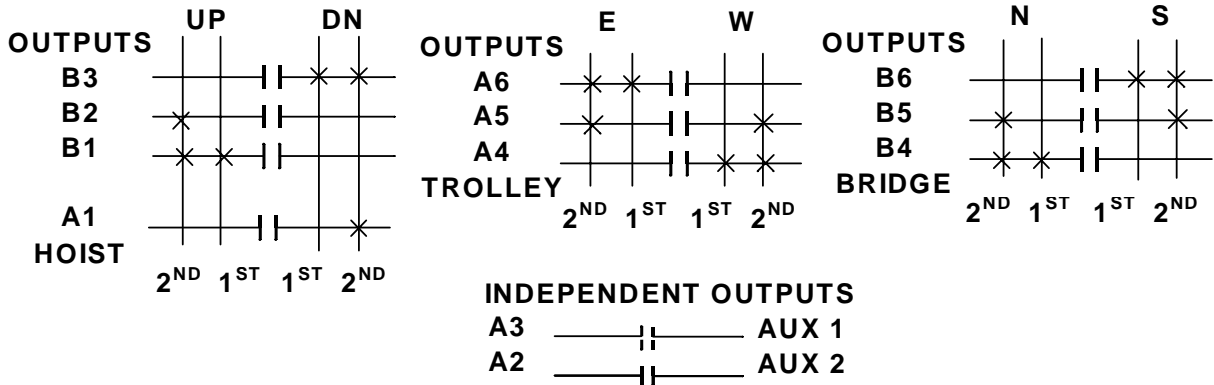

STANDARD OUTPUTS	STANDARD OUTPUTS	OPTIONAL OUTPUT BOARD OPTION #1	OPTIONAL OUTPUT BOARD OPTION #2
A1 HOIST DOWN 2 ND SPEED	B1 HOIST UP	C1 AUX 3	C1 AUX 3
A2 AUX 2 (LATCHABLE S2-6)	B2 HOIST UP 2 ND SPEED	C2	C2
A3 AUX 1 (LATCHABLE S2-7)	B3 HOIST DOWN	C3 MULTIBOX 1	C3
A4 TROLLEY WEST	B4 BRIDGE NORTH	C4 MULTIBOX 2	C4
A5 TROLLEY 2 ND SPEED	B5 BRIDGE 2 ND SPEED	C5 MULTIBOX 3	C5
A6 TROLLEY EAST	B6 BRIDGE SOUTH	C6 MULTIBOX 4	C6

Membrane Transmitter and Receiver Switch Select:
 Switch settings Sw3-5 to Sw3-7 are defined as follows (for Optional Output Board in the Receiver Sw3-3 must be "ON" for Option #1 and "OFF" for Option #2):

TRANSMITTER SWITCH SETTINGS:

Type	Sw3-5	Sw3-6	Sw3-7
6	OFF	ON	ON

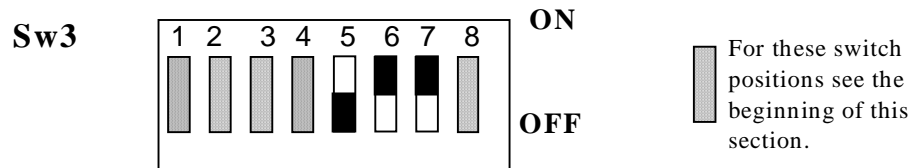

NOTE: Transmitter Sw4 positions 1 and 2 must be set to "OFF" for Sw3 to function.

*Appendix B - 10K12 2-Speed Membrane Transmitter
Programming (Continued)*

TABLE 1(h)

Time-out –timer disable for 2-speed membrane transmitter only.

Sw3 position 4 can disable the transmitter time-out-timer.

Sw3

Transmitter time-out-timer active.

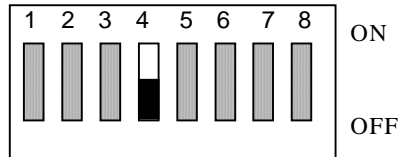

Sw3

Transmitter time-out-timer turned off.

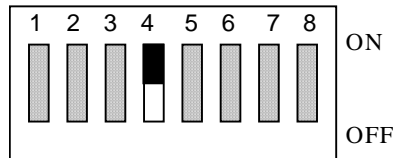

NOTE: Transmitter Sw4 positions 1 and 2 must be set to “OFF” for Sw3 to function.

**Appendix B - 10K12 2-Speed Membrane Transmitter
Programming (Continued)**

TABLE 1(i)

Repositioning of transmitter pushbutton switch functions for 2-speed membrane transmitter only.

Sw3 positions 1 through 3 can change the functional positions of the switches controlling bridge, hoist and trolley. This can be useful to align East/West and North/South. This reconfiguration does NOT affect receiver wiring.

WARNING

CHANGING THESE SWITCHES CHANGES THE FUNCTIONAL OPERATION OF THE CRANE IN RELATIONSHIP TO THE TRANSMITTER BUTTON BEING DEPRESSED. THE FUNCTIONAL OPERATION OF THE CRANE SHOULD NEVER BE CHANGED WITHOUT ALL PERSONNEL RESPONSIBLE FOR CRANE OPERATION BEING NOTIFIED PRIOR TO MODIFICATION.

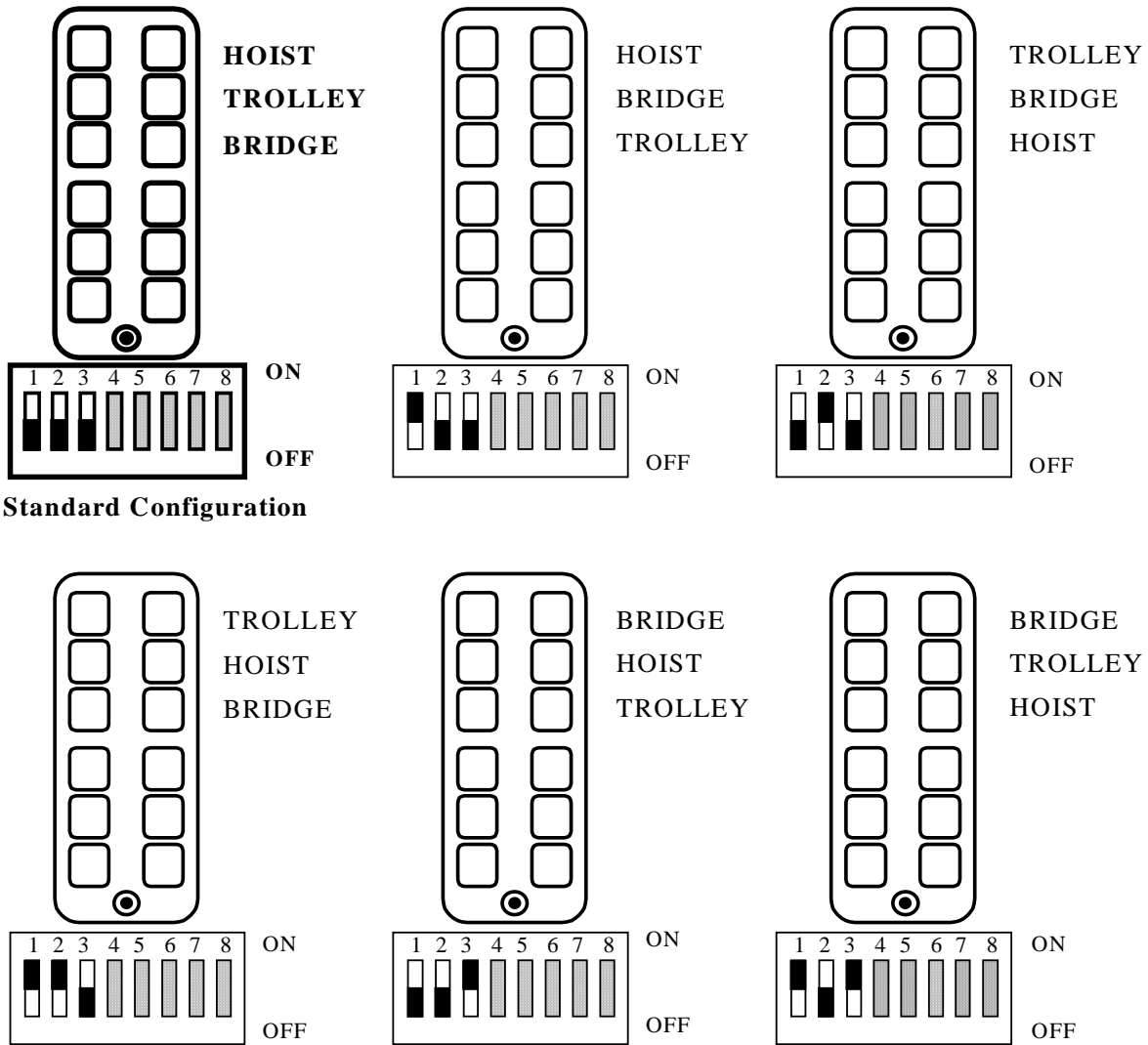

*Appendix B - 10K12 2-Speed Membrane Transmitter
Programming (Continued)*

This Page Intentionally Left Blank

Appendix C - 10K16/24 Pendant and SLTX Transmitter Programming

NOTE: This section also contains information on Optional Output Board for Multibox and other optional outputs for use with the 10K16.

Appendix C - 10K16/24 Pendant and SLTX Transmitter Programming (Continued)

C-1. Transmitter Switches Sw3 and Sw4 Programming. (See Sections 6-2 and 6-4 for physical location of transmitter switches).

C-1.1. Transmitter programming Sw3

C-1.1.1. Positions 1-3 (Pendant only) Switch Positioning. (Standard configuration all “OFF”).

The functional positions of the various buttons controlling the hoist trolley and bridge can be moved by transmitter dip switch Sw3 also. Positions Sw3-1 through Sw3-3 control these functions. No change in receiver wiring is needed to use these functions. See [TABLE 2\(k\)](#) for switch versus button configurations.

C-1.1.2. Positions 1-3 (SLTX only) no function. (Keep turned “OFF”).

C-1.1.3. Positions 4-7 no function. (Keep turned “OFF”).

C-1.1.4. Position 8 Time-out-timer Disable. (Normally keep turned “OFF”).

The transmitter has an approximate 15-minute time-out-timer. If the transmitter is not used for over 15 minutes it will shut down. This transmitter time-out-timer function is transmitter dip switch selectable. Sw3 position 8 disables the time-out-timer. Turning Sw3-8 “ON” disables the time-out-timer.

C-1.2. Transmitter programming Sw4

C-1.2.1. Position 1-2 Mode Enable. (Standard Mode 1 keep 1-2 turned “OFF”).

Mode 1, Sw4 1-2 all “OFF”. The 10K16 3-speed system comes standard configured this way from the factory with three 3-speed controls and four auxiliaries. The 10K24 3-speed system comes standard configured this way from the factory with five 3-speed controls and four auxiliaries.

Mode 2, Sw4 1 turned “ON” and Sw4 2 turned “OFF”. The 10K24 configured this way gives hoist, trolley and bridge

with independent select functions. The system utilizes separate select relays with common speed and direction.

Mode 3, Sw4 1 turned “OFF” and Sw4 2 turned “ON”. The 10K24 configured this way is four motor 3-speed selectable by the rotary switch. Two hoists, one trolley and one bridge with main hoist (H1), auxiliary hoist (H2), and “both” (B) main and auxiliary hoists are selectable by the rotary switch.

C-1.2.2. Position 3 Disable Tandem for hoist and trolley. (Normally keep turned “OFF”).

For cranes with auxiliary hoists and/or trolleys, turning this switch “ON” disables the transmitter selector switch “B” position (both function) that selects tandem operation of hoist or trolley.

C-1.2.3. Position 4 Invert Crane Select Aux. Outputs. (Normally keep turned “OFF”).

For cranes that use the select function only, turning this switch “ON” inverts the select function operation so that the relay closes for the unselected function.

C-1.2.4. Positions 5-7 Extended Crane Control Configurations. (Standard all “OFF” otherwise see TABLES 1 and 2)

The 10K16/24 Pendant and SLTX transmitter is available with extended crane control configurations. These options are switch configurable on the transmitter. The eight-position dip switches Sw3 and Sw4 can provide all configurations with a single transmitter CPU EPROM. TABLES 1 and 2 show the available configurations and the switch programming needed to provide them. The standard transmitter comes with the output configuration shown either in [TABLE 1\(a\)](#) or [TABLE 2\(a\)](#): TYPE 0 and has no extended crane control configurations. For extended crane control configurations: See TABLE 1 or TABLE 2: TYPE 1 through CONFIGURATION 4 respectively. If a configuration listed in these TABLES is preferred over the standard configuration, please reprogram Sw3 and Sw4 respectively in the transmitter.

C-1.2.5. Position 8 no function. (Keep turned “OFF”).

Appendix C - 10K16/24 Pendant and SLTX Transmitter Programming (Continued)

C-2. Replacement Transmitter EPROM's

All 10K16/24 Pendant (10K12 Pendant transmitters normally have a black top and a yellow bottom. 10K16/24 pendant transmitters normally have a yellow top and black bottom.) and SLTX transmitters use CPU EPROM part numbers as listed below:

Pendant 3 Motor	Three speed	10K16/18	FW10K16P-1
Pendant 4/5 Motor	Three speed	10K24	FW10K24P-2
Pendant 7 Motor	Three speed	10K24	FW2797-1
SLTX 3 Motor	Three speed	10K16/18	FW2819-0
SLTX 3/4/5 Motor	Three speed	10K24	FW2820-0
SLTX 3/4/5 Motor	Five speed	10K24	FW2818-0

C-3. Multibox and Optional Output Board:

WARNING

IF YOUR UNIT WAS NOT ORDERED WITH MULTIBOX DO NOT ATTEMPT TO PROGRAM MULTIBOX IN THE FIELD. TELEMOTIVE MUST COORDINATE ACCESS CODE ASSIGNMENTS WITH THE TRANSMITTERS PRIOR TO ENABLING MULTIBOX. PLEASE CONTACT TELEMOTIVE IF YOU NEED TO ADD MULTIBOX. FAILURE TO DO SO CAN BE A SERIOUS SAFETY HAZARD.

If Multibox is used (**Receiver** CPU Board switch **Sw3-3** is "ON" and the Optional Output Board is installed in the receiver for 10K16). The outputs are as follows:

C1 MULTIBOX 1
C2 MULTIBOX 2
C3 MULTIBOX 3
C4 MULTIBOX 4

C-3.1. 10k16 Only

C5-C6 NO FUNCTION
C7 AUX 5
C8 AUX 6

C-3.2. 10K24 Only

Without Multibox most of the 10K24 configurations have the first 4 relays C1-C4 as Aux Hoist and the second four relays C5-C8 as Aux Trolley. For those systems that are 4 relays Aux Hoist and four relays Aux Trolley Multibox uses the first four positions C1-C4 thus eliminating them for motion control. Leaving the last four C5-C8 for either Aux Hoist or Aux Trolley. S3 position 4 on the Receiver CPU Board selects either Aux Trolley S3-4 "OFF" or Aux Hoist S3-4 "ON" functions on relays C5-C8.



C-4. Latching of Auxiliary Relays

Certain auxiliary relays can be set to latch (be toggled on and off) by setting dip switch S2 positions 6-8 on the **Receiver** CPU Board. If an Aux function is latchable it is noted in the programming diagram by the following note (LATCHABLE S2-#) where # is the switch position 6-8 that must be turned on for the latching function.

Appendix C - 10K16/24 Pendant and SLTX Transmitter Programming (Continued)

C-5. TABLE 1(a) through TABLE 1(g) Wiring and Programming Diagrams

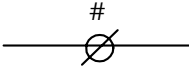
The following tables give various extended crane configurations. Functional terms like Trolley South and Hoist Up match standard transmitter labeling from the factory. The following legend is used in these diagrams:

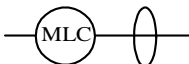
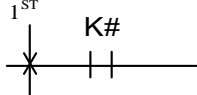
			
<p>Indicates terminal block J2 or J3 with terminal number # in the radio receiver output board</p>	<p>Indicates terminal block J1 in power supply board with the required connection noted.</p>	<p>Indicates customer supplied contactor coil with arc suppressor in parallel.</p>	<p>Indicates a relay contact in radio receiver number #. The X indicates the relay closing and the closing sequence (1st, 2nd, etc.) as the indicated switch is depressed.</p>

In the following wiring diagrams the relay outputs AJ2, BJ2 and CJ2 have listed to the right of the output terminal the appropriate motor function they control, i.e., trolley, hoist etc. Proper installation requires that this output be wired to a contactor controlling that function and that the contactor has the proper arc suppressor across it. The relays on these output boards are rated at 16 amps and fused at 10 amps unless otherwise noted.

C-6. Optional 110 Volt Wiring

Power supply wiring is accomplished through connector J1 on the power supply board. The connections labeled 240, 120, N and GND are wired to the appropriate supply connections per the wiring diagrams. An extra connection 120 is provided for 120 Volt applications only for jumpering to Pins 2 and 6 of the Master Relay (MR) K1 on the power supply board. The unit may optionally be wired as in [Figure C-1](#). [Figure C-2](#) shows the wiring layout for the 10K16 and [Figure C-3](#) shows the wiring layout for the 10K24. All other wiring is accomplished per the attached tables.

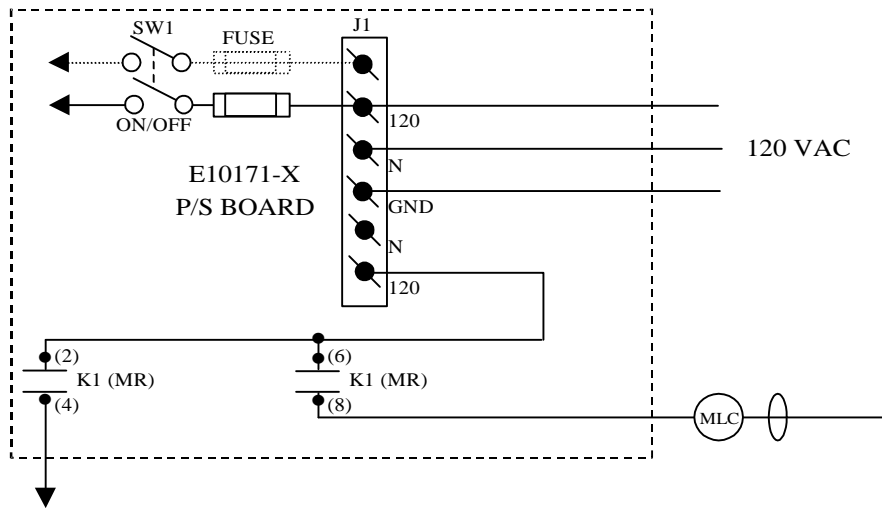

Figure C-1. Optional 120 VAC Wiring

Appendix C - 10K16/24 Pendant and SLTX Transmitter Programming (Continued)

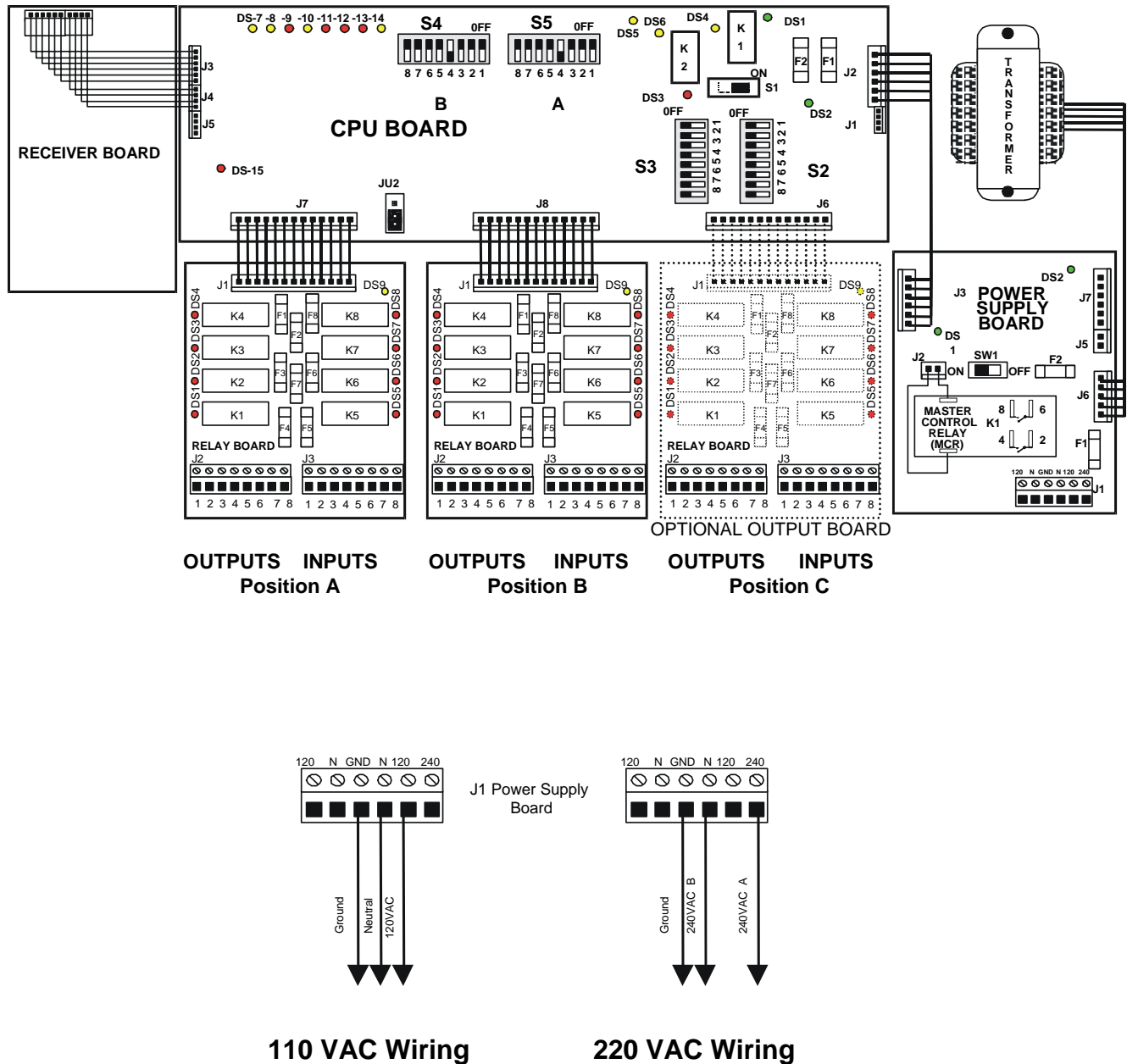

Figure C-2. 10K16 Wiring Layout

C-7. Crane Control Type Selection

The crane control type selection information is provided in [TABLE 1\(a\)](#) through [TABLE 2\(k\)](#). Each table defines a specific configuration and provides a wiring diagram, a programming diagram, and a transmitter and receiver switch settings. The table for each configuration is provided on facing pages so that all information is easily accessible.

**Appendix C - 10K16/24 Pendant and SLTX
Transmitter Programming (Continued)**

TABLE 1(a)

Crane Control Type Selection: 10K16 TYPE 0 WIRING DIAGRAM

STANDARD CONFIGURATION: ALL MOTIONS
(HOIST, TROLLEY and BRIDGE)

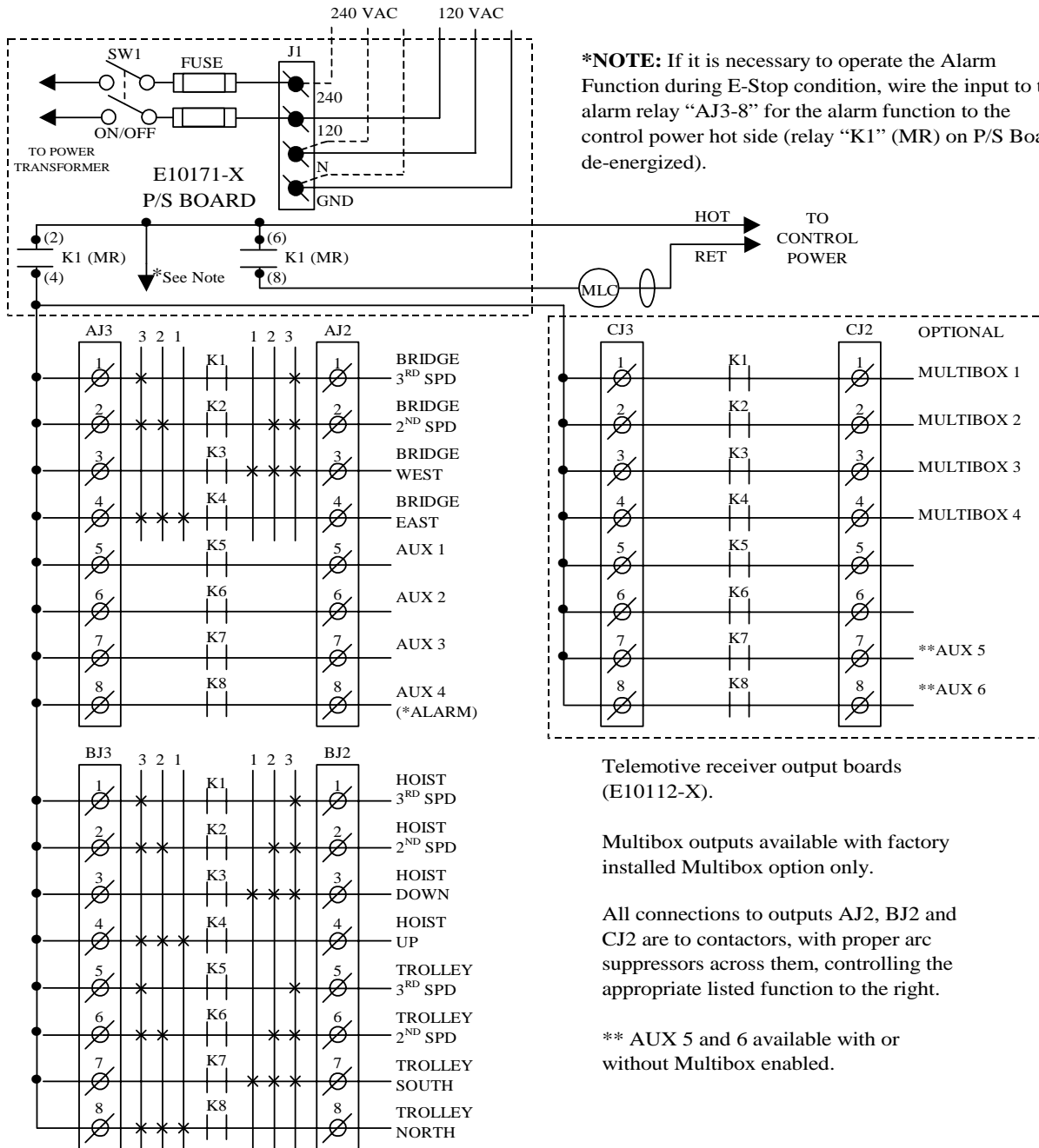

***NOTE:** If it is necessary to operate the Alarm Function during E-Stop condition, wire the input to the alarm relay "AJ3-8" for the alarm function to the control power hot side (relay "K1" (MR) on P/S Board de-energized).

Telemotive receiver output boards (E10112-X).

Multibox outputs available with factory installed Multibox option only.

All connections to outputs AJ2, BJ2 and CJ2 are to contactors, with proper arc suppressors across them, controlling the appropriate listed function to the right.

** AUX 5 and 6 available with or without Multibox enabled.

**Appendix C - 10K16/24 Pendant and SLTX
Transmitter Programming (Continued)**

TABLE 1(a)

Crane Control Type Selection: 10K16 TYPE 0 PROGRAMMING

STANDARD CONFIGURATION: ALL MOTIONS
(HOIST, TROLLEY and BRIDGE)

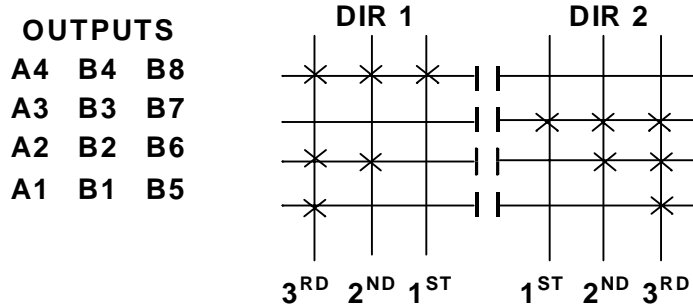

A4-A1 BRIDGE

OUTPUT DEFINITIONS

B4-B1 HOIST

- A4 EAST
- A3 WEST
- A2 2ND SPEED
- A1 3RD SPEED

B8-B5 TROLLEY

- B4 UP
- B3 DOWN
- B2 2ND SPEED
- B1 3RD SPEED

- B8 NORTH
- B7 SOUTH
- B6 2ND SPEED
- B5 3RD SPEED

INDEPENDENT OUTPUTS

- A8 AUX 4 (ALARM)
- A7 AUX 3 (LATCHABLE S2-6)
- A6 AUX 2 (LATCHABLE S2-7)
- A5 AUX 1 (LATCHABLE S2-8)
- *C8 AUX 6
- *C7 AUX 5
- *C4 MULTIBOX 4
- *C3 MULTIBOX 3
- *C2 MULTIBOX 2
- *C1 MULTIBOX 1

*NOTE: ON OPTIONAL OUTPUT BOARD

Transmitter Switch Select: Switch settings **Sw4-5** to **Sw4-8** are defined as follows:

SWITCH SETTINGS	TYPE	Sw4-8	Sw4-7	Sw4-6	Sw4-5
	0	OFF	OFF	OFF	OFF

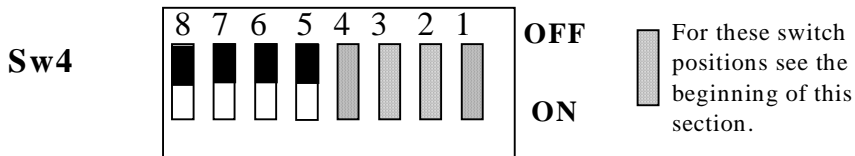

**Appendix C - 10K16/24 Pendant and SLTX
Transmitter Programming (Continued)**

TABLE 1(b)

Crane Control Type Selection: 10K16 TYPE 1 WIRING DIAGRAM

2-SPEED with DIRECTIONAL CONTROL: ALL MOTIONS

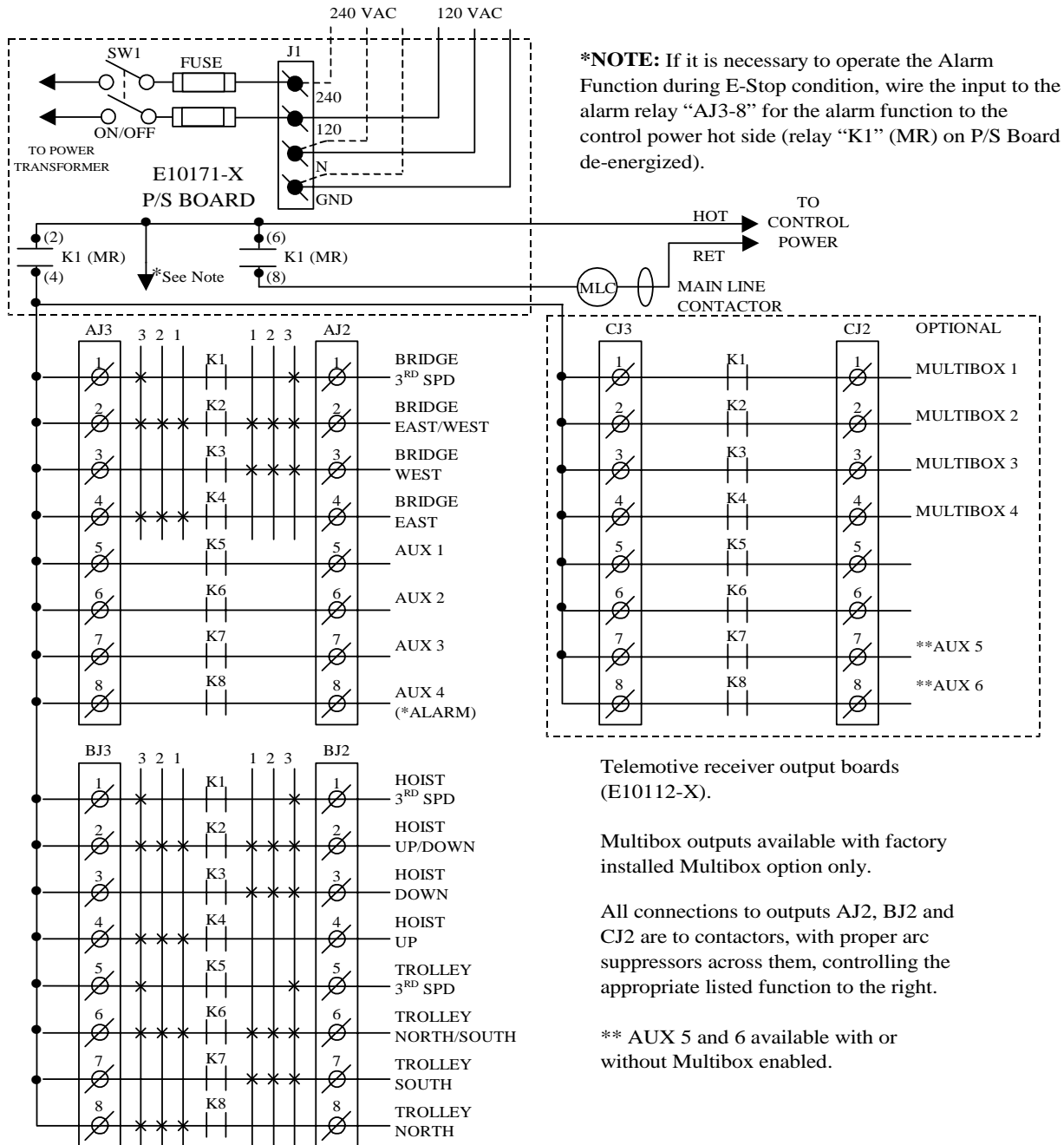

Telemotive receiver output boards (E10112-X).

Multibox outputs available with factory installed Multibox option only.

All connections to outputs AJ2, BJ2 and CJ2 are to contactors, with proper arc suppressors across them, controlling the appropriate listed function to the right.

** AUX 5 and 6 available with or without Multibox enabled.

**Appendix C - 10K16/24 Pendant and SLTX
Transmitter Programming (Continued)**

TABLE 1(b)

Crane Control Type Selection: 10K16 TYPE 1 PROGRAMMING

2-SPEED with DIRECTIONAL CONTROL: ALL MOTIONS

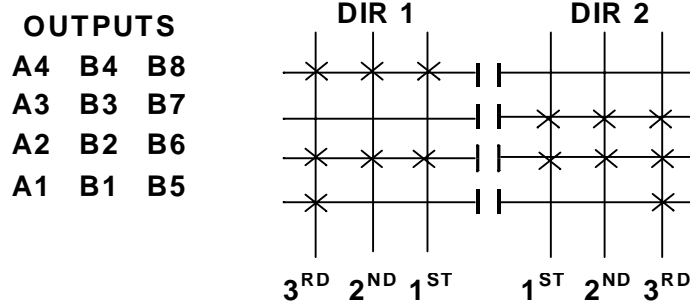

OUTPUT DEFINITIONS

A4-A1 BRIDGE
A4 EAST
A3 WEST
A2 EAST/WEST
A1 3RD SPEED

B4-B1 HOIST
B4 UP
B3 DOWN
B2 UP/DOWN
B1 3RD SPEED

B8-B5 TROLLEY
B8 NORTH
B7 SOUTH
B6 NORTH/SOUTH
B5 3RD SPEED

INDEPENDENT OUTPUTS

A8 AUX 4 (ALARM)
A7 AUX 3 (LATCHABLE S2-6)
A6 AUX 2 (LATCHABLE S2-7)
A5 AUX 1 (LATCHABLE S2-8)

*C8 AUX 6
*C7 AUX 5

*C4 MULTIBOX 4
*C3 MULTIBOX 3
*C2 MULTIBOX 2
*C1 MULTIBOX 1

*NOTE: ON OPTIONAL OUTPUT BOARD

Transmitter Switch Select: Switch settings **Sw4-5** to **Sw4-8** are defined as follows:

SWITCH SETTINGS:	<u>TYPE</u>	<u>Sw4-8</u>	<u>Sw4-7</u>	<u>Sw4-6</u>	<u>Sw4-5</u>
	1	OFF	OFF	OFF	ON

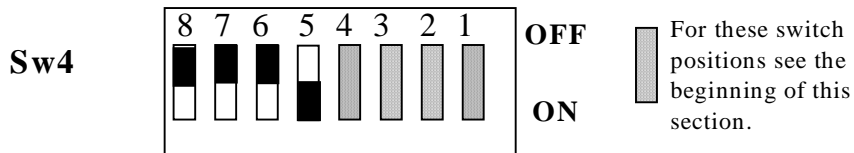

**Appendix C - 10K16/24 Pendant and SLTX
Transmitter Programming (Continued)**

TABLE 1(c)

Crane Control Type Selection: 10K16 TYPE 2 WIRING DIAGRAM

2-SPEED, 2-WINDINGS: ALL MOTIONS

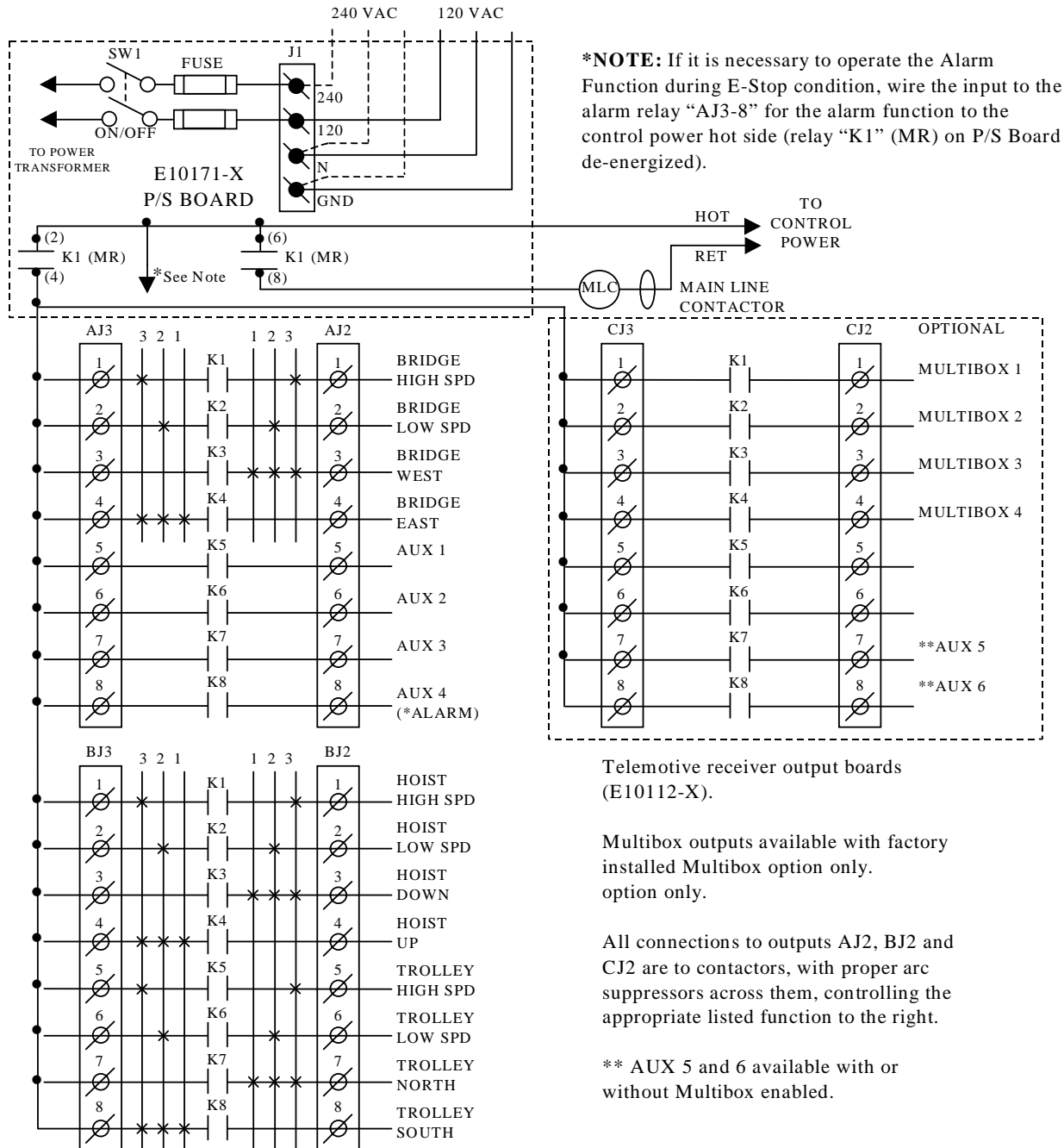

**Appendix C - 10K16/24 Pendant and SLTX
Transmitter Programming (Continued)**

TABLE 1(c)

Crane Control Type Selection: 10K16 TYPE 2 PROGRAMMING

2-SPEED, 2-WINDINGS: ALL MOTIONS

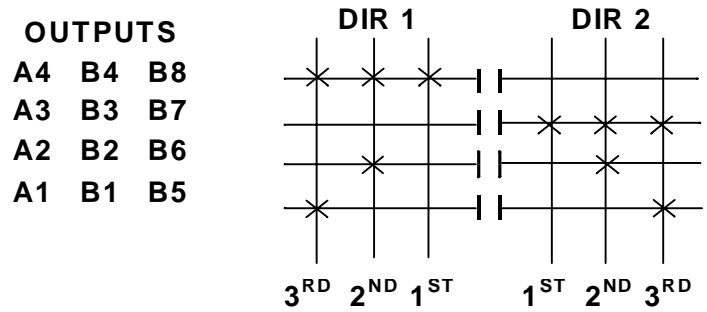

OUTPUT DEFINITIONS

A4-A1 BRIDGE
A4 EAST
A3 WEST
A2 LOW SPEED
A1 HIGH SPEED

B4-B1 HOIST
B4 UP
B3 DOWN
B2 LOW SPEED
B1 HIGH SPEED

B8-B5 TROLLEY
B8 SOUTH
B7 NORTH
B6 LOW SPEED
B5 HIGH SPEED

INDEPENDENT OUTPUTS

A8 AUX 4 (ALARM)
A7 AUX 3 (LATCHABLE S2-6)
A6 AUX 2 (LATCHABLE S2-7)
A5 AUX 1 (LATCHABLE S2-8)

*C8 AUX 6
*C7 AUX 5

*C4 MULTIBOX 4
*C3 MULTIBOX 3
*C2 MULTIBOX 2
*C1 MULTIBOX 1

*NOTE: ON OPTIONAL OUTPUT BOARD

Transmitter Switch Select: Switch settings **Sw4-5** to **Sw4-8** are defined as follows:

SWITCH SETTINGS:	<u>TYPE</u>	<u>Sw4-8</u>	<u>Sw4-7</u>	<u>Sw4-6</u>	<u>Sw4-5</u>
	2	OFF	OFF	ON	OFF

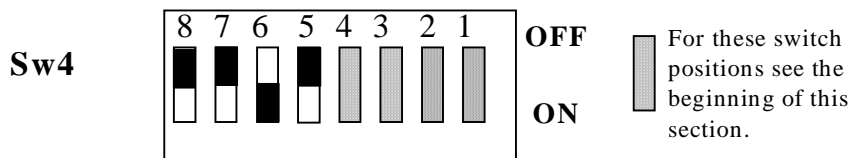

**Appendix C - 10K16/24 Pendant and SLTX
Transmitter Programming (Continued)**

TABLE 1(d)

Crane Control Type Selection: 10K16 TYPE 3 WIRING DIAGRAM

ACCO CONTROLS: ALL MOTIONS

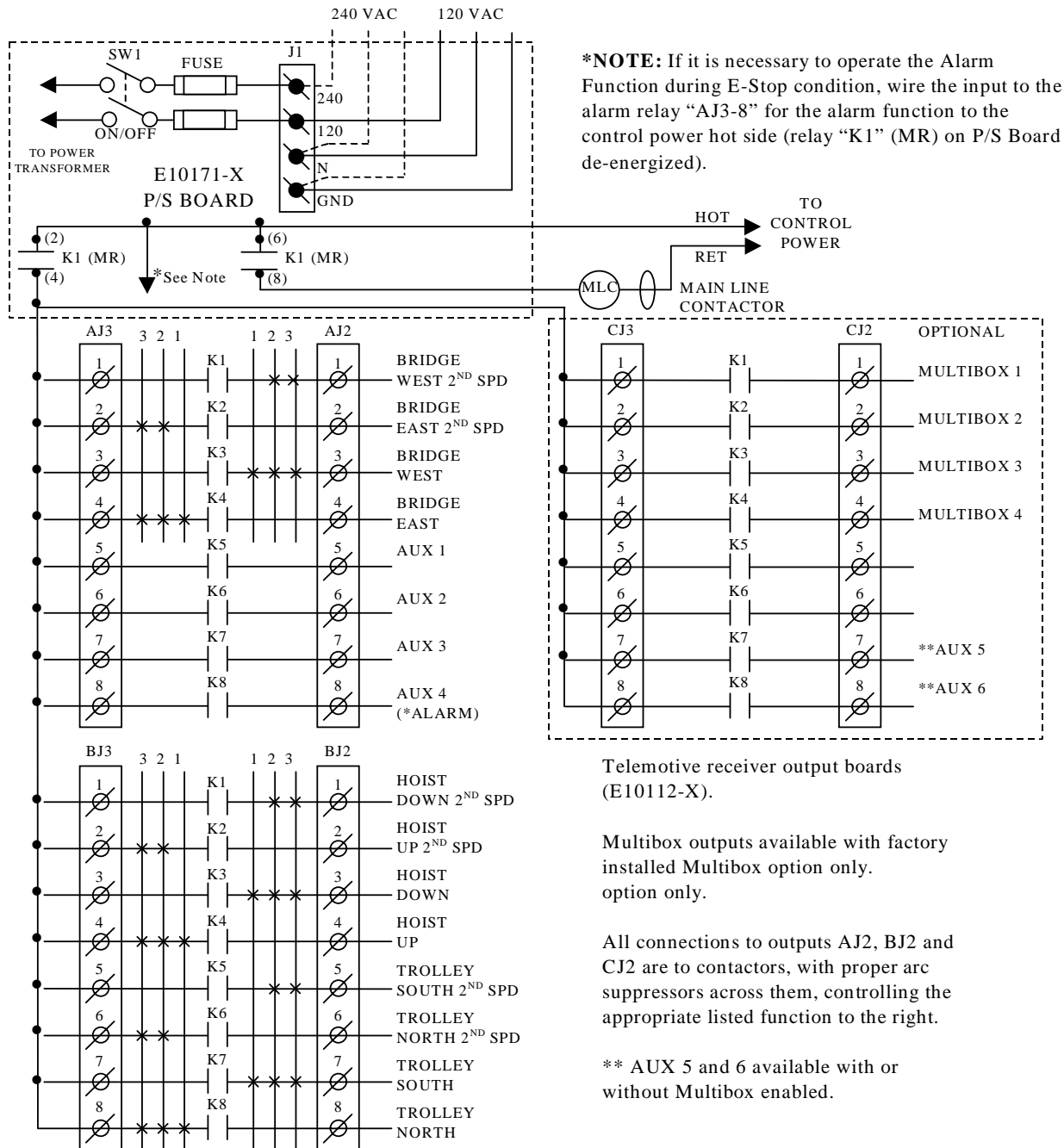

**Appendix C - 10K16/24 Pendant and SLTX
Transmitter Programming (Continued)**

TABLE 1(d)

Crane Control Type Selection: 10K16 TYPE 3 PROGRAMMING

ACCO CONTROLS: ALL MOTIONS

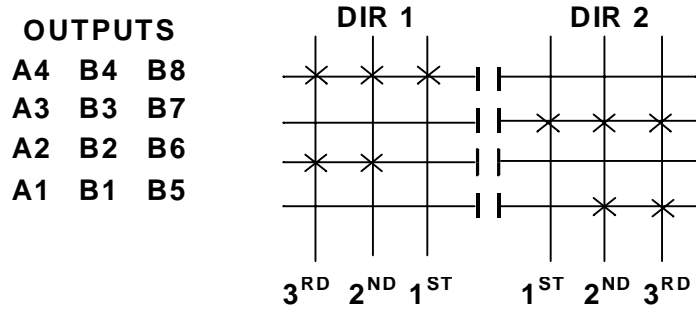

OUTPUT DEFINITIONS

A4-A1 BRIDGE

- A4 EAST
- A3 WEST
- A2 EAST 2ND SPEED
- A1 WEST 2ND SPEED

B4-B1 HOIST

- B4 UP
- B3 DOWN
- B2 UP 2ND SPEED
- B1 DOWN 2ND SPEED

B8-B5 TROLLEY

- B8 NORTH
- B7 SOUTH
- B6 NORTH 2ND SPEED
- B5 SOUTH 2ND SPEED

INDEPENDENT OUTPUTS

- A8 AUX 4 (ALARM)
- A7 AUX 3 (LATCHABLE S2-6)
- A6 AUX 2 (LATCHABLE S2-7)
- A5 AUX 1 (LATCHABLE S2-8)

- *C8 AUX 6
- *C7 AUX 5

- *C4 MULTIBOX 4
- *C3 MULTIBOX 3
- *C2 MULTIBOX 2
- *C1 MULTIBOX 1

*NOTE: ON OPTIONAL OUTPUT BOARD

Transmitter Switch Select: Switch settings **Sw4-5** to **Sw4-8** are defined as follows:

SWITCH SETTINGS:	<u>TYPE</u>	<u>Sw4-8</u>	<u>Sw4-7</u>	<u>Sw4-6</u>	<u>Sw4-5</u>
	3	OFF	OFF	ON	ON

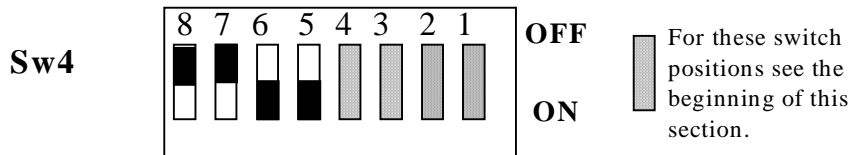

**Appendix C - 10K16/24 Pendant and SLTX
Transmitter Programming (Continued)**

TABLE 1(e)

Crane Control Type Selection: 10K16 TYPE 4 WIRING DIAGRAM

**DEMAG: 2-SPEED, 2-WINDINGS for HOIST:
STANDARD BRIDGE and TROLLEY**

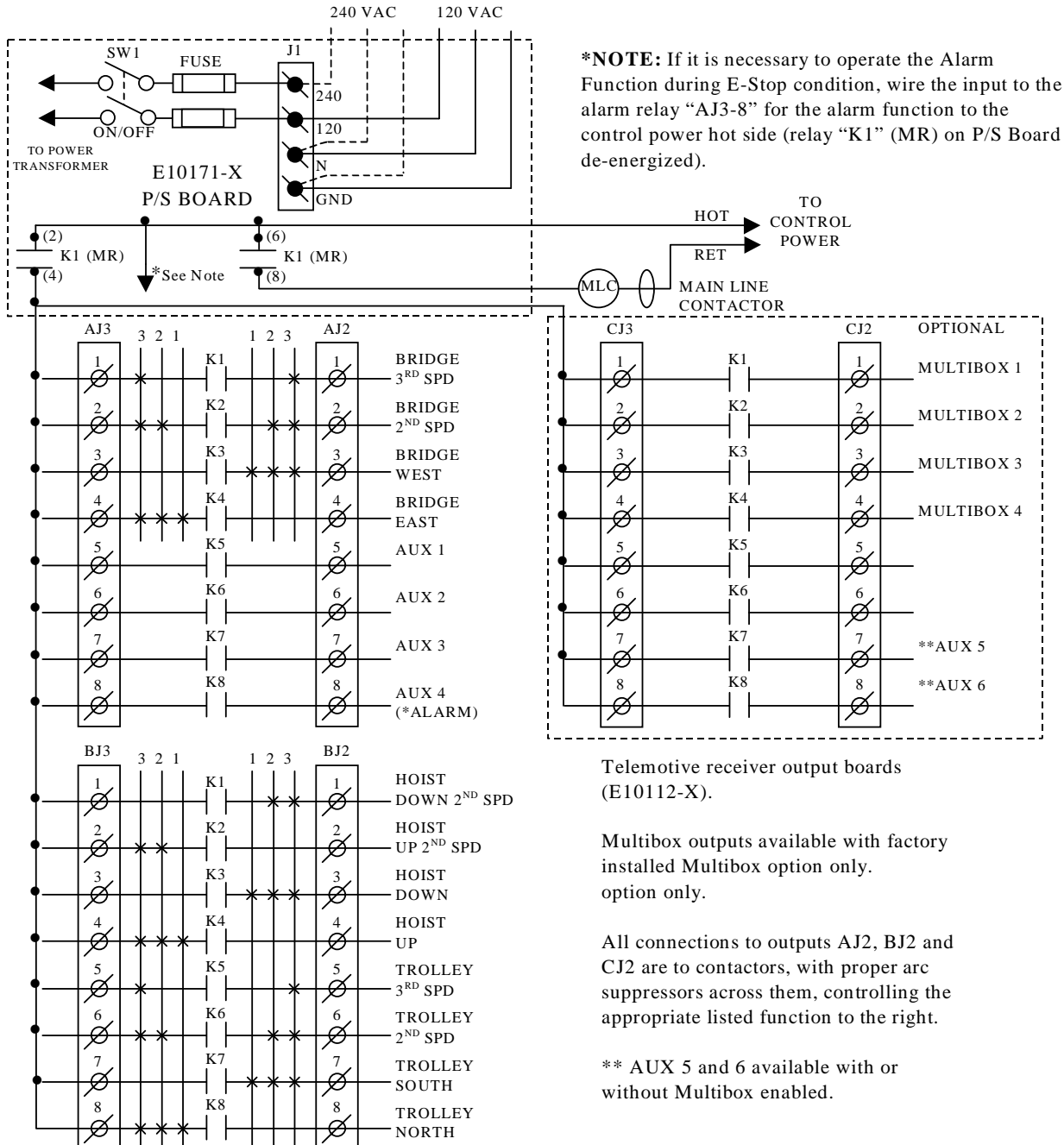

**Appendix C - 10K16/24 Pendant and SLTX
Transmitter Programming (Continued)**

TABLE 1(e)

Crane Control Type Selection: 10K16 TYPE 4 PROGRAMMING

**DEMAG: 2-SPEED, 2-WINDINGS for HOIST:
STANDARD BRIDGE and TROLLEY**

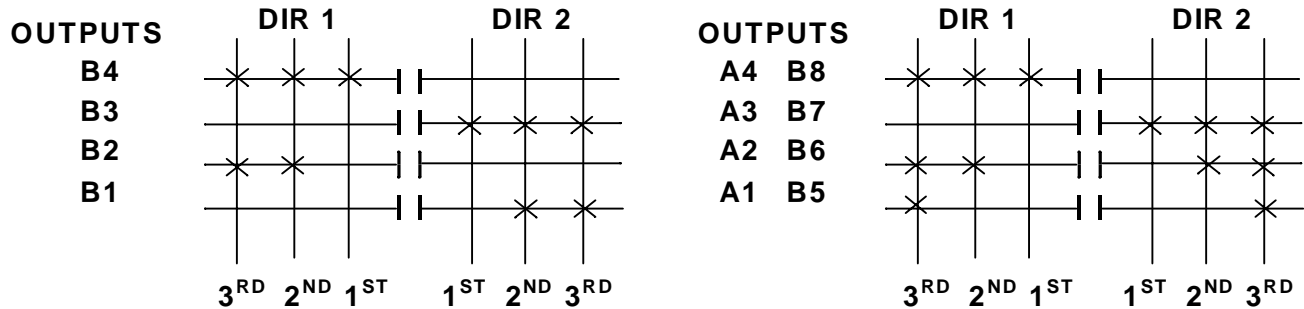

OUTPUT DEFINITIONS

A4-A1 BRIDGE

- A4 EAST
- A3 WEST
- A2 2ND SPEED
- A1 3RD SPEED

B4-B1 HOIST

- B4 UP
- B3 DOWN
- B2 UP 2ND SPEED
- B1 DOWN 2ND SPEED

B8-B5 TROLLEY

- B8 NORTH
- B7 SOUTH
- B6 2ND SPEED
- B5 3RD SPEED

INDEPENDENT OUTPUTS

- | | | |
|---------------------------|-----------|----------------|
| A8 AUX 4 (ALARM) | *C8 AUX 6 | *C4 MULTIBOX 4 |
| A7 AUX 3 (LATCHABLE S2-6) | *C7 AUX 5 | *C3 MULTIBOX 3 |
| A6 AUX 2 (LATCHABLE S2-7) | | *C2 MULTIBOX 2 |
| A5 AUX 1 (LATCHABLE S2-8) | | *C1 MULTIBOX 1 |
- *NOTE: ON OPTIONAL OUTPUT BOARD

Transmitter Switch Select: Switch settings Sw4-5 to Sw4-8 are defined as follows:

SWITCH SETTINGS:	<u>TYPE</u>	<u>Sw4-8</u>	<u>Sw4-7</u>	<u>Sw4-6</u>	<u>Sw4-5</u>
	4	OFF	ON	OFF	OFF

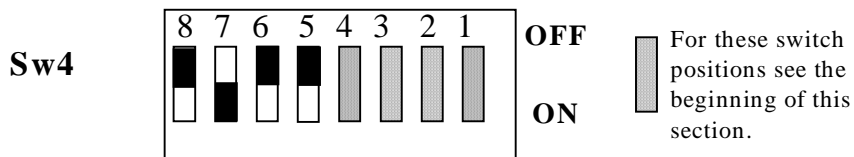

**Appendix C - 10K16/24 Pendant and SLTX
Transmitter Programming (Continued)**

TABLE 1(f)

Crane Control Type Selection: 10K16 TYPE 5 WIRING DIAGRAM

**P&H HOIST: 2-SPEED, 2-WINDINGS for HOIST:
STANDARD BRIDGE and TROLLEY**

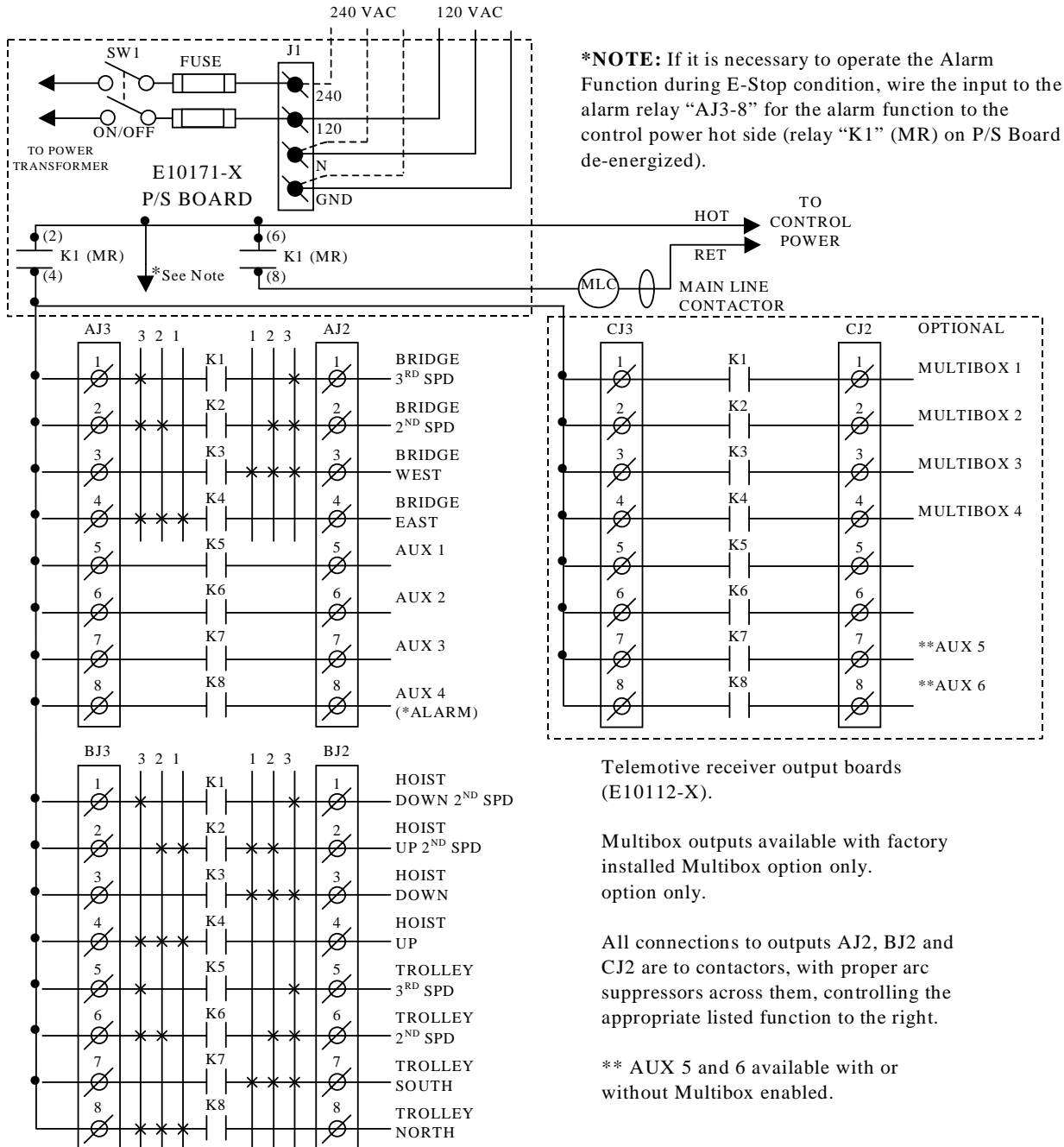

**Appendix C - 10K16/24 Pendant and SLTX
Transmitter Programming (Continued)**

TABLE 1(f)

Crane Control Type Selection: 10K16 TYPE 5 PROGRAMMING

**P&H HOIST: 2-SPEED, 2-WINDINGS for HOIST:
STANDARD BRIDGE and TROLLEY**

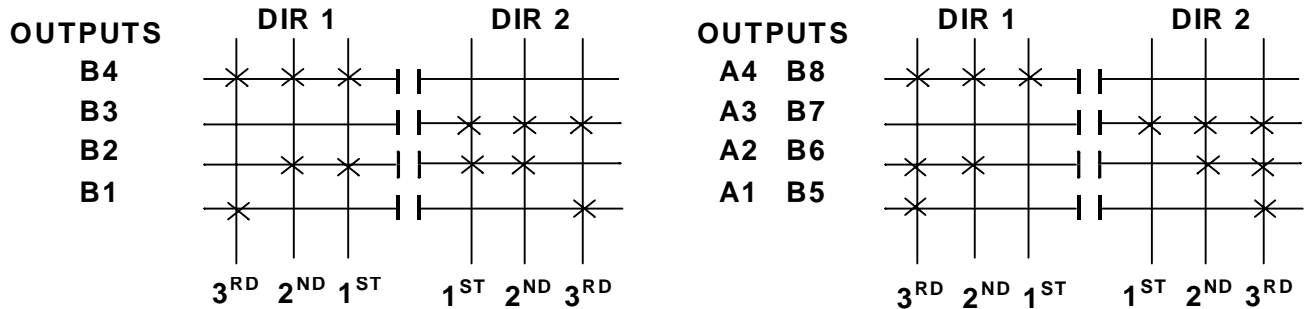

OUTPUT DEFINITIONS

A4-A1 BRIDGE

- A4 EAST
- A3 WEST
- A2 2ND SPEED
- A1 3RD SPEED

B4-B1 HOIST

- B4 UP
- B3 DOWN
- B2 UP 2ND SPEED
- B1 DOWN 2ND SPEED

B8-B5 TROLLEY

- B8 NORTH
- B7 SOUTH
- B6 2ND SPEED
- B5 3RD SPEED

INDEPENDENT OUTPUTS

- | | | |
|---------------------------|-----------|----------------|
| A8 AUX 4 (ALARM) | *C8 AUX 6 | *C4 MULTIBOX 4 |
| A7 AUX 3 (LATCHABLE S2-6) | *C7 AUX 5 | *C3 MULTIBOX 3 |
| A6 AUX 2 (LATCHABLE S2-7) | | *C2 MULTIBOX 2 |
| A5 AUX 1 (LATCHABLE S2-8) | | *C1 MULTIBOX 1 |

*NOTE: ON OPTIONAL OUTPUT BOARD

Transmitter Switch Select: Switch settings **Sw4-5** to **Sw4-8** are defined as follows:

SWITCH SETTINGS:	<u>TYPE</u>	<u>Sw4-8</u>	<u>Sw4-7</u>	<u>Sw4-6</u>	<u>Sw4-5</u>
	5	OFF	ON	OFF	ON

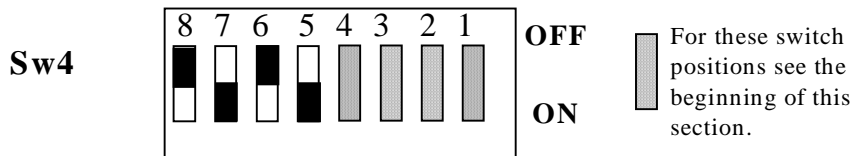

**Appendix C - 10K16/24 Pendant and SLTX
Transmitter Programming (Continued)**

TABLE 1(g)

Crane Control Type Selection: 10K16 TYPE 6 WIRING DIAGRAM

**P&H HOIST: 2-SPEED, 2-WINDINGS for HOIST and TROLLEY:
STANDARD BRIDGE**

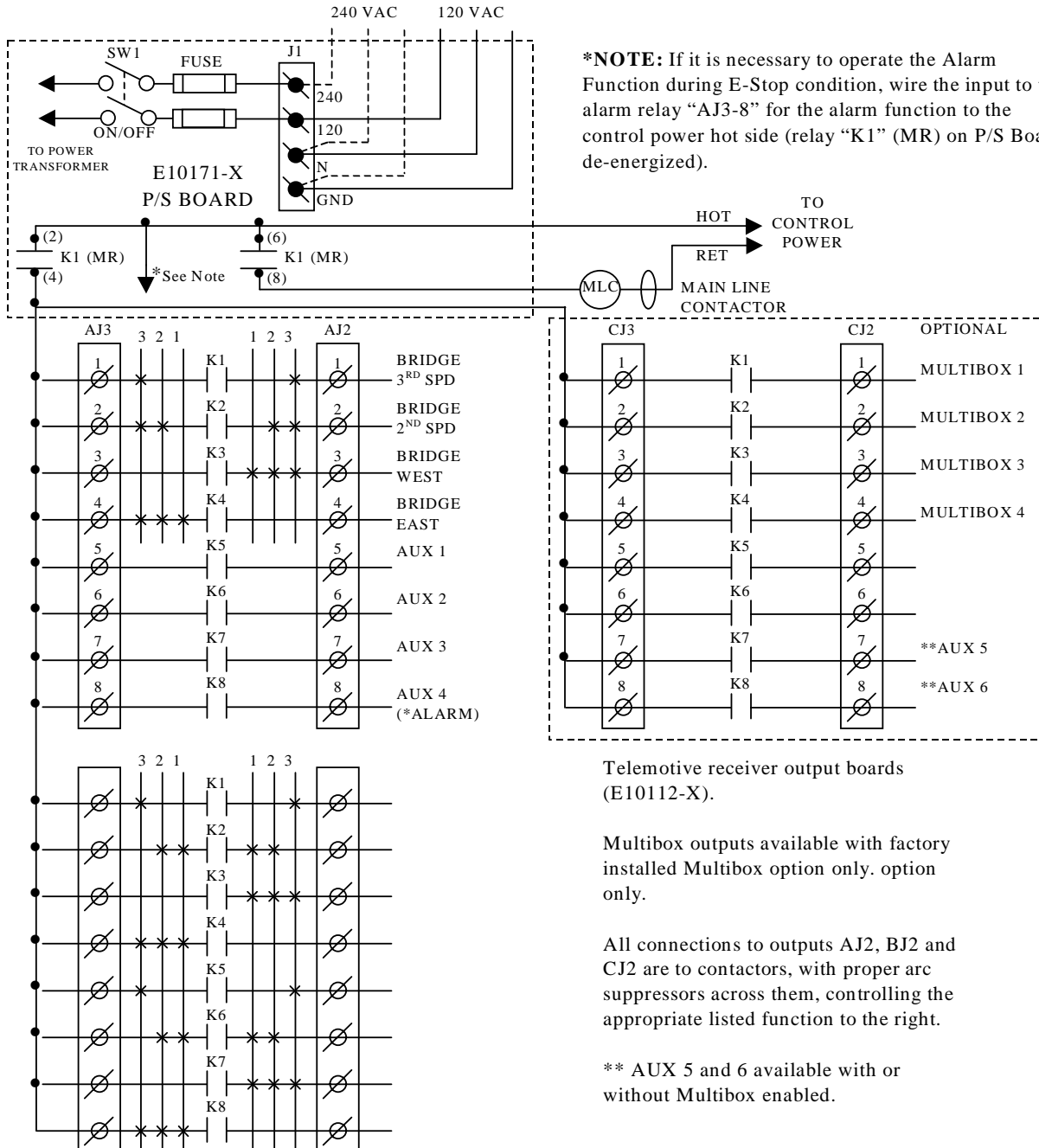

**Appendix C - 10K16/24 Pendant and SLTX
Transmitter Programming (Continued)**

TABLE 1(g)

Crane Control Type Selection: 10K16 TYPE 6 PROGRAMMING

**P&H HOIST: 2-SPEED, 2-WINDINGS HOIST and TROLLEY:
STANDARD BRIDGE**

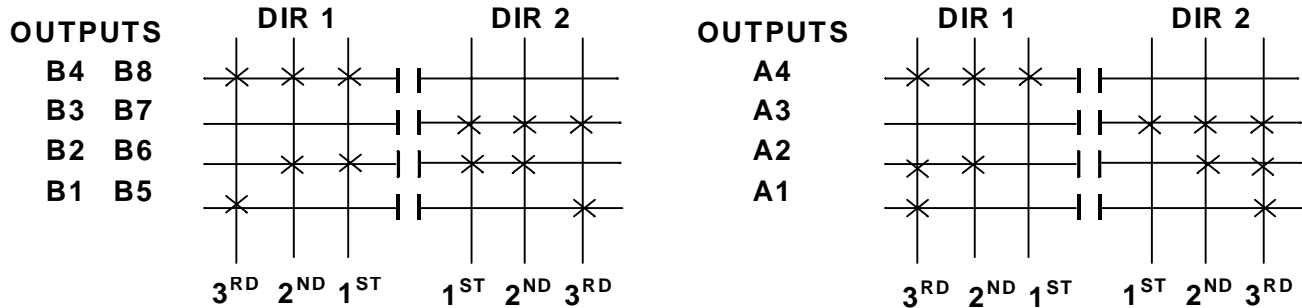

OUTPUT DEFINITIONS

A4-A1 BRIDGE

- A4 EAST
- A3 WEST
- A2 2ND SPEED
- A1 3RD SPEED

B4-B1 HOIST

- B4 UP
- B3 DOWN
- B2 LOW SPEED
- B1 HIGH SPEED

B8-B5 TROLLEY

- B8 NORTH
- B7 SOUTH
- B6 LOW SPEED
- B5 HIGH SPEED

INDEPENDENT OUTPUTS

- | | | |
|---------------------------|-----------|----------------|
| A8 AUX 4 (ALARM) | *C8 AUX 6 | *C4 MULTIBOX 4 |
| A7 AUX 3 (LATCHABLE S2-6) | *C7 AUX 5 | *C3 MULTIBOX 3 |
| A6 AUX 2 (LATCHABLE S2-7) | | *C2 MULTIBOX 2 |
| A5 AUX 1 (LATCHABLE S2-8) | | *C1 MULTIBOX 1 |
- *NOTE: ON OPTIONAL OUTPUT BOARD

Transmitter Switch Select: Switch settings Sw4-5 to Sw4-8 are defined as follows:

SWITCH SETTINGS:	<u>TYPE</u>	<u>Sw4-8</u>	<u>Sw4-7</u>	<u>Sw4-6</u>	<u>Sw4-5</u>
	6	OFF	ON	ON	OFF

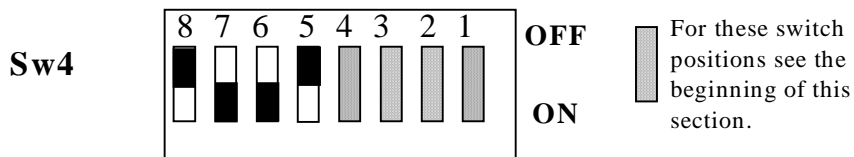

*Appendix C - 10K16/24 Pendant and SLTX
Transmitter Programming (Continued)*

This Page Intentionally Left Blank

**Appendix C - 10K16/24 Pendant and SLTX
Transmitter Programming (Continued)**

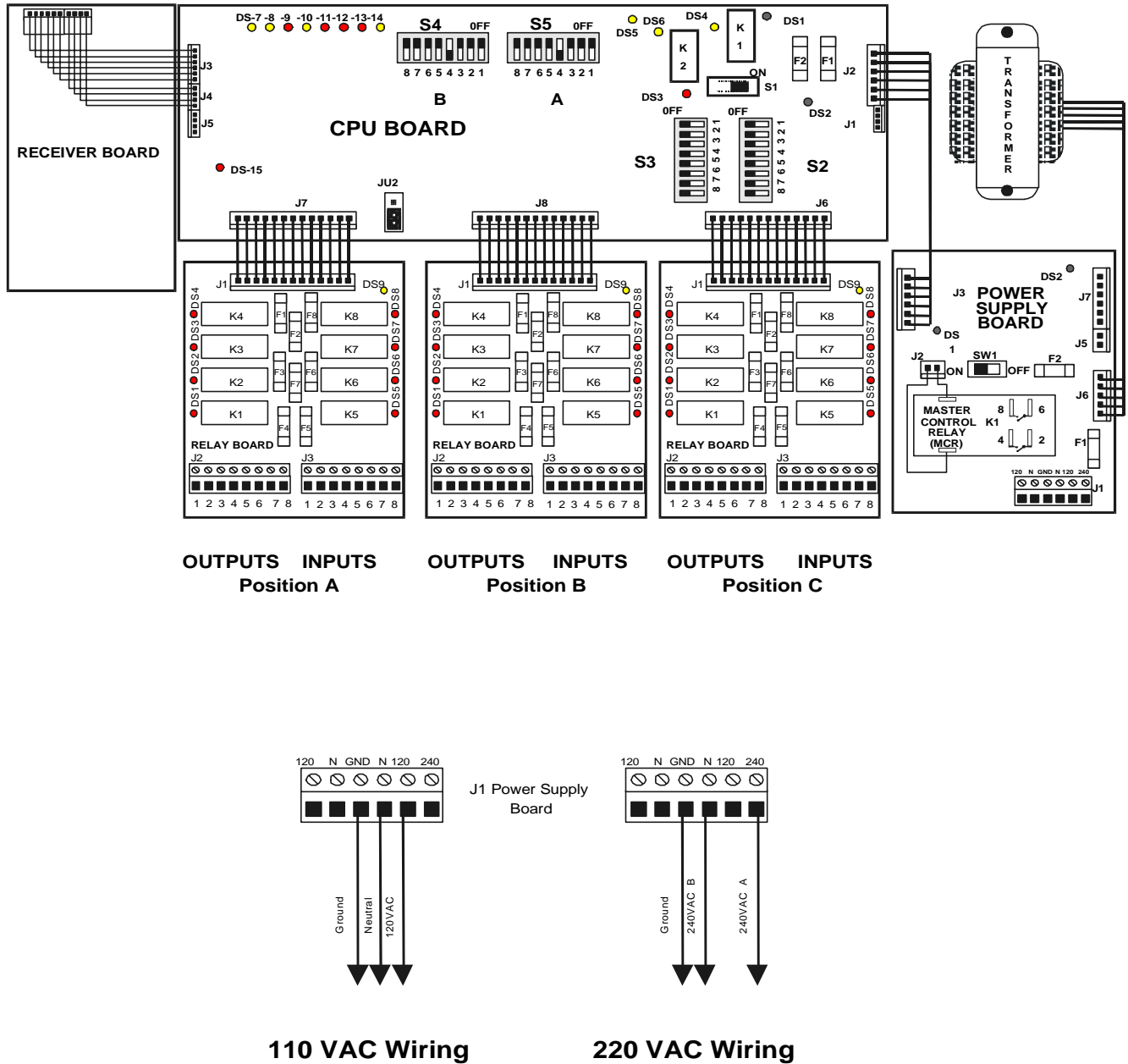

Figure C-3. 10K24 Wiring Layout

**Appendix C - 10K16/24 Pendant and SLTX
Transmitter Programming (Continued)**

TABLE 2(a)

Crane Control Type Selection: 10K24 TYPE 0 WIRING DIAGRAM

STANDARD CONFIGURATION: ALL MOTIONS
(HOIST, TROLLEY and BRIDGE)

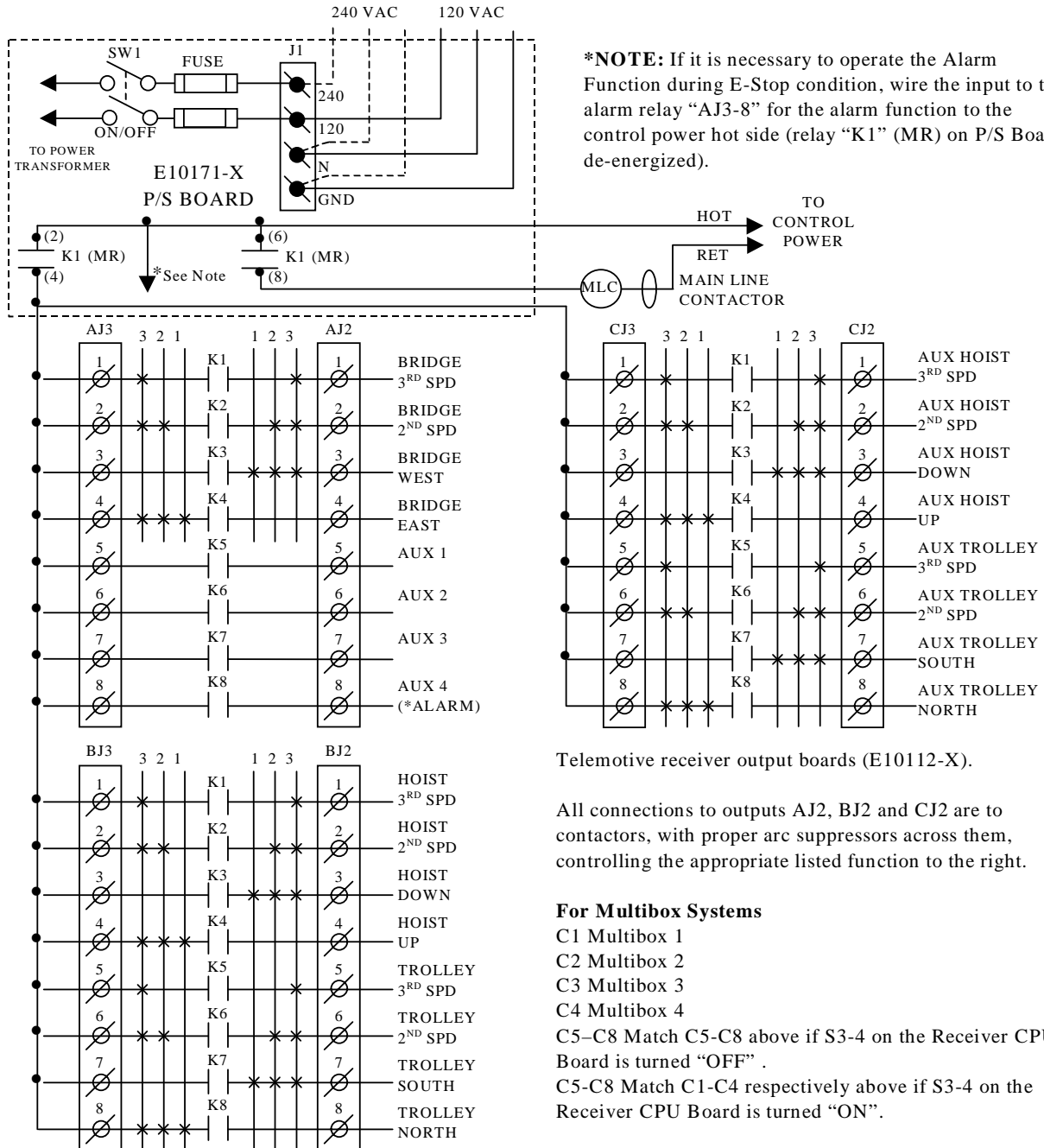

**Appendix C - 10K16/24 Pendant and SLTX
Transmitter Programming (Continued)**

TABLE 2(a)

Crane Control Type Selection: 10K24 TYPE 0 PROGRAMMING

STANDARD CONFIGURATION: ALL MOTIONS
(HOIST, TROLLEY and BRIDGE)

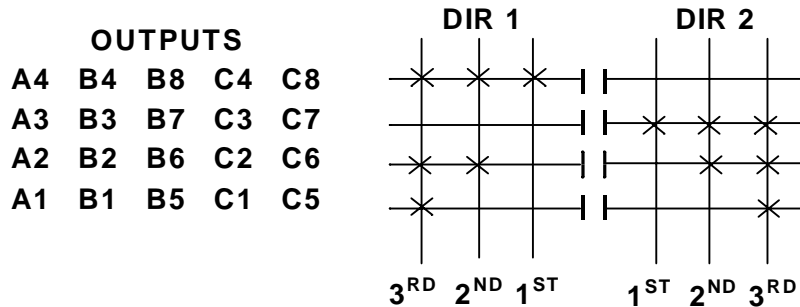

OUTPUT DEFINITIONS*

A4-A1 BRIDGE	B4-B1 HOIST	B8-B5 TROLLEY	C4-C1 AUX HOIST	C8-C5 AUX TROLLEY
A4 EAST	B4 UP	B8 NORTH	C4 UP	C8 NORTH
A3 WEST	B3 DOWN	B7 SOUTH	C3 DOWN	C7 SOUTH
A2 2 ND SPD	B2 2 ND SPD	B6 2 ND SPD	C2 2 ND SPD	C6 2 ND SPD
A1 3 RD SPD	B1 3 RD SPD	B5 3 RD SPD	C1 3 RD SPD	C5 3 RD SPD

INDEPENDENT OUTPUTS

- A8 AUX 4 (ALARM)
- A7 AUX 3 (LATCHABLE S2-6)
- A6 AUX 2 (LATCHABLE S2-7)
- A5 AUX 1 (LATCHABLE S2-8)

*For Multibox Systems read Multibox details at the beginning of this section.

Transmitter Switch Select: Switch settings **Sw4-5** to **Sw4-8** are defined as follows:

SWITCH SETTINGS:	<u>TYPE</u>	<u>Sw4-8</u>	<u>Sw4-7</u>	<u>Sw4-6</u>	<u>Sw4-5</u>
	0	OFF	OFF	OFF	OFF

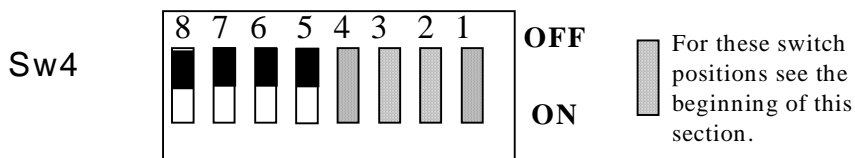

**Appendix C - 10K16/24 Pendant and SLTX
Transmitter Programming (Continued)**

TABLE 2(b)

Crane Control Type Selection: 10K24 TYPE 1 WIRING DIAGRAM

2-SPEED with DIRECTIONAL CONTROL: ALL MOTIONS

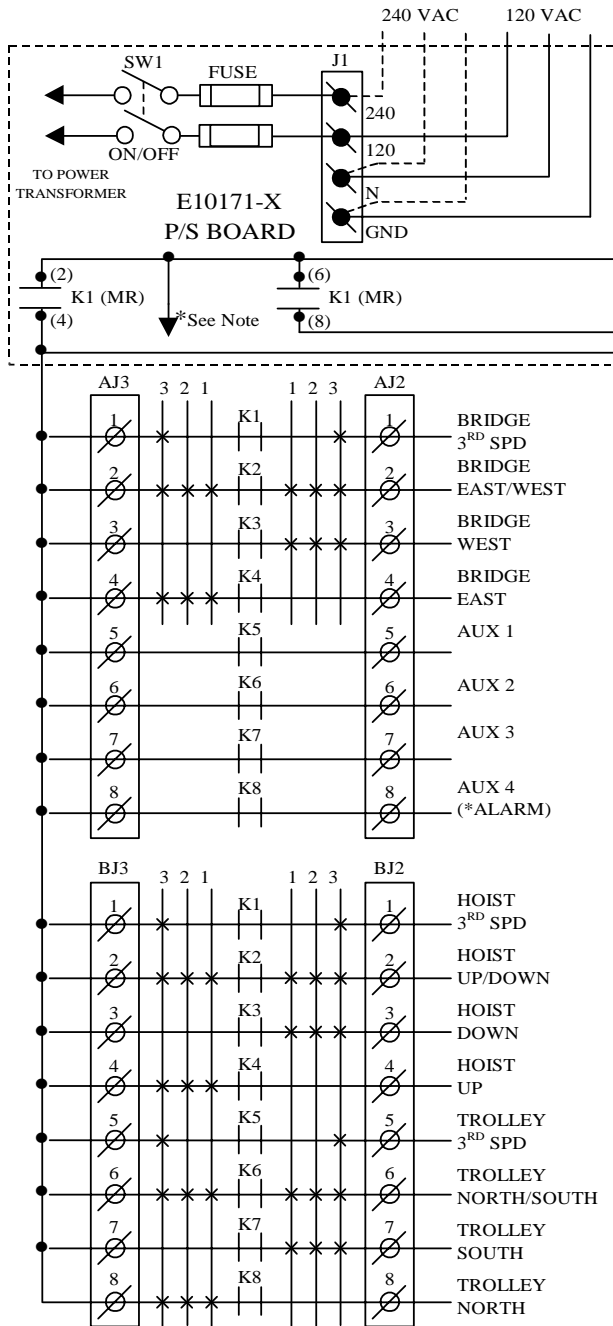

***NOTE:** If it is necessary to operate the Alarm Function during E-Stop condition, wire the input to the alarm relay "AJ3-8" for the alarm function to the control power hot side (relay "K1" (MR) on P/S Board de-energized).

Telemotive receiver output boards (E10112-X).

All connections to outputs AJ2, BJ2 and CJ2 are to contactors, with proper arc suppressors across them, controlling the appropriate listed function to the right.

For Multibox Systems

- C1 Multibox 1
- C2 Multibox 2
- C3 Multibox 3
- C4 Multibox 4
- C5-C8 Match C5-C8 above if S3-4 on the Receiver CPU Board is turned "OFF".
- C5-C8 Match C1-C4 respectively above if S3-4 on the Receiver CPU Board is turned "ON".

**Appendix C - 10K16/24 Pendant and SLTX
Transmitter Programming (Continued)**

TABLE 2(b)

Crane Control Type Selection: 10K24 TYPE 1 PROGRAMMING

2-SPEED with DIRECTIONAL CONTROL: ALL MOTIONS

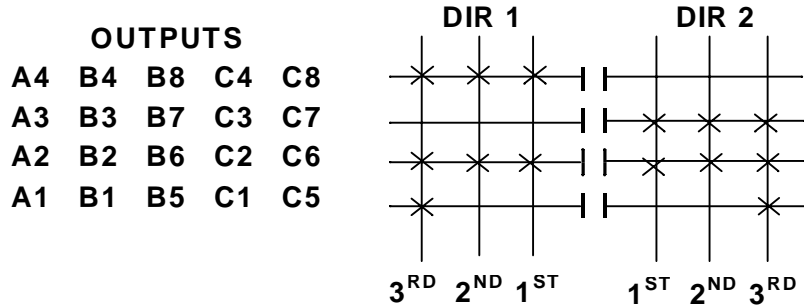

OUTPUT DEFINITIONS*

A4-A1 BRIDGE	B4-B1 HOIST	B8-B5 TROLLEY	C4-C1 AUX HOIST	C8-C5 AUX TROLLEY
A4 EAST	B4 UP	B8 NORTH	C4 UP	C8 NORTH
A3 WEST	B3 DOWN	B7 SOUTH	C3 DOWN	C7 SOUTH
A2 EAST/WEST	B2 UP/DOWN	B6 NORTH/SOUTH	C2 UP/DOWN	C6 NORTH/SOUTH
A1 3 RD SPD	B1 3 RD SPD	B5 3 RD SPD	C1 3 RD SPD	C5 3 RD SPD

INDEPENDENT OUTPUTS

- A8 AUX 4 (ALARM)
- A7 AUX 3 (LATCHABLE S2-6)
- A6 AUX 2 (LATCHABLE S2-7)
- A5 AUX 1 (LATCHABLE S2-8)

*For Multibox Systems read Multibox details at the beginning of this section.

Transmitter Switch Select: Switch settings **Sw4-5** to **Sw4-8** are defined as follows:

SWITCH SETTINGS:	<u>TYPE</u>	<u>Sw4-8</u>	<u>Sw4-7</u>	<u>Sw4-6</u>	<u>Sw4-5</u>
	1	OFF	OFF	OFF	ON

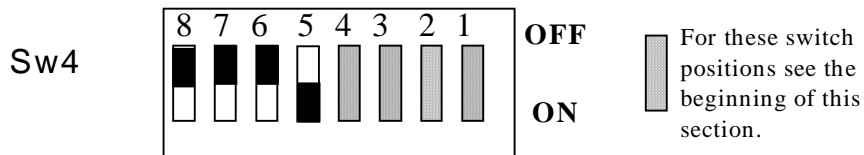

**Appendix C - 10K16/24 Pendant and SLTX
Transmitter Programming (Continued)**

TABLE 2(c)

Crane Control Type Selection: 10K24 TYPE 2 WIRING DIAGRAM

2-SPEED, 2-WINDINGS: ALL MOTIONS

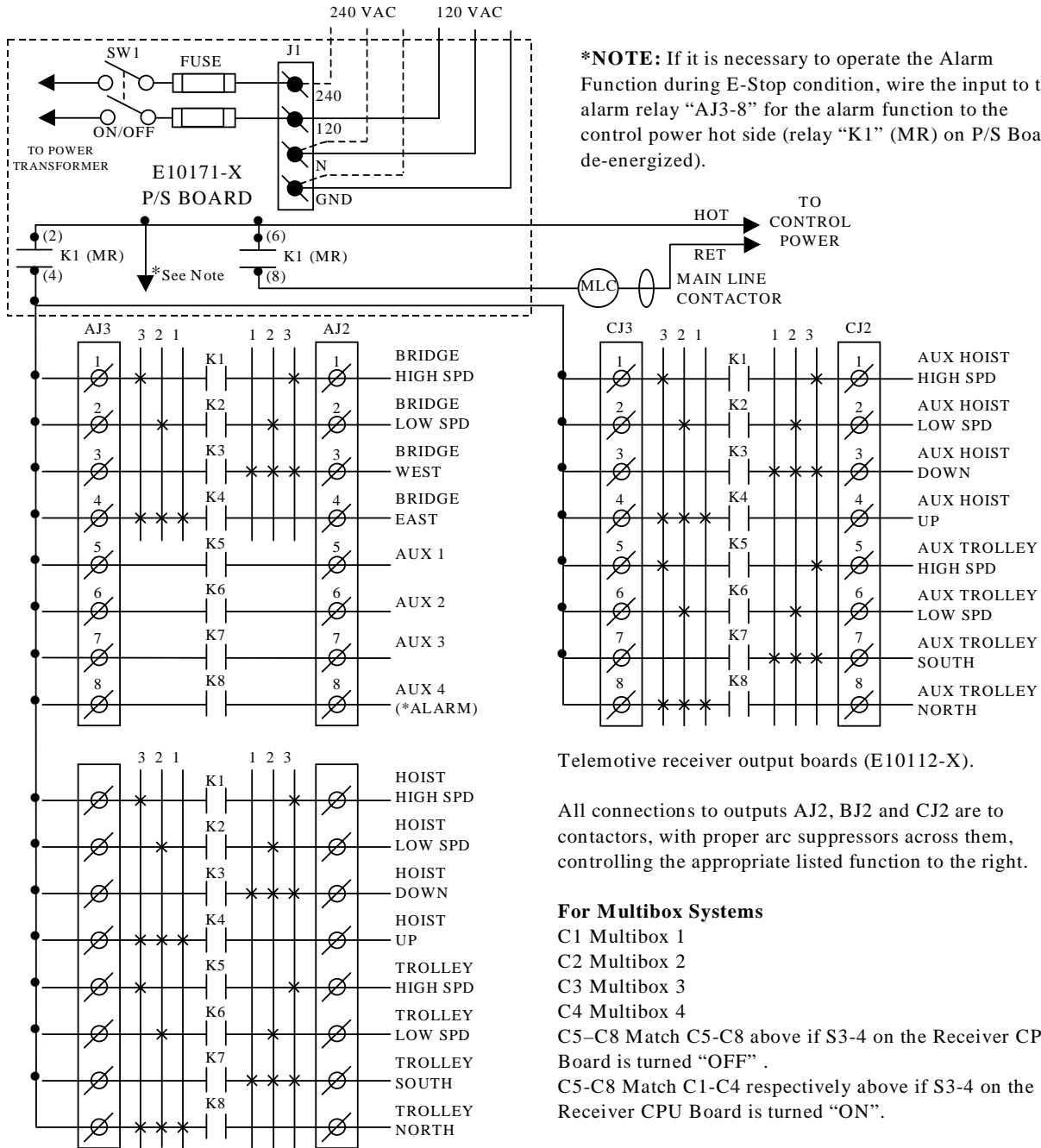

Telemotive receiver output boards (E10112-X).

All connections to outputs AJ2, BJ2 and CJ2 are to contactors, with proper arc suppressors across them, controlling the appropriate listed function to the right.

For Multibox Systems

- C1 Multibox 1
- C2 Multibox 2
- C3 Multibox 3
- C4 Multibox 4
- C5-C8 Match C5-C8 above if S3-4 on the Receiver CPU Board is turned "OFF".
- C5-C8 Match C1-C4 respectively above if S3-4 on the Receiver CPU Board is turned "ON".

*Appendix C - 10K16/24 Pendant and SLTX
Transmitter Programming (Continued)*

TABLE 2(c)

Crane Control Type Selection: 10K24 TYPE 2 PROGRAMMING

2-SPEED, 2-WINDINGS: ALL MOTIONS

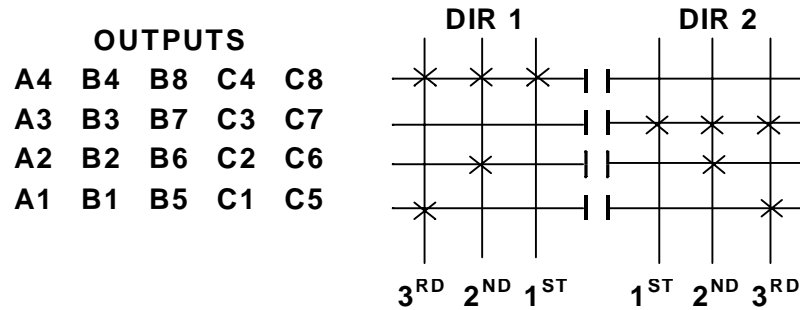

OUTPUT DEFINITIONS*

A4-A1 BRIDGE	B4-B1 HOIST	B8-B5 TROLLEY	C4-C1 AUX HOIST	C8-C5 AUX TROLLEY
A4 EAST	B4 UP	B8 NORTH	C4 UP	C8 NORTH
A3 WEST	B3 DOWN	B7 SOUTH	C3 DOWN	C7 SOUTH
A2 LOW SPD	B2 LOW SPD	B6 LOW SPD	C2 LOW SPD	C6 LOW SPD
A1 HIGH SPD	B1 HIGH SPD	B5 HIGH SPD	C1 HIGH SPD	C5 HIGH SPD

INDEPENDENT OUTPUTS

- A8 AUX 4 (ALARM)
- A7 AUX 3 (LATCHABLE S2-6)
- A6 AUX 2 (LATCHABLE S2-7)
- A5 AUX 1 (LATCHABLE S2-8)

*For Multibox Systems read Multibox details at the beginning of this section.

Transmitter Switch Select: Switch settings Sw4-5 to Sw4-8 are defined as follows:

SWITCH SETTINGS:	<u>TYPE</u>	<u>Sw4-8</u>	<u>Sw4-7</u>	<u>Sw4-6</u>	<u>Sw4-5</u>
	2	OFF	OFF	ON	OFF

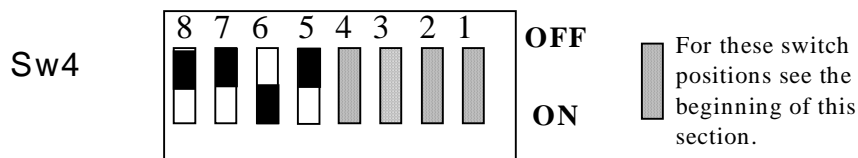

**Appendix C - 10K16/24 Pendant and SLTX
Transmitter Programming (Continued)**

TABLE 2(d)

Crane Control Type Selection: 10K24 TYPE 3 WIRING DIAGRAM

ACCO CONTROLS: ALL MOTIONS

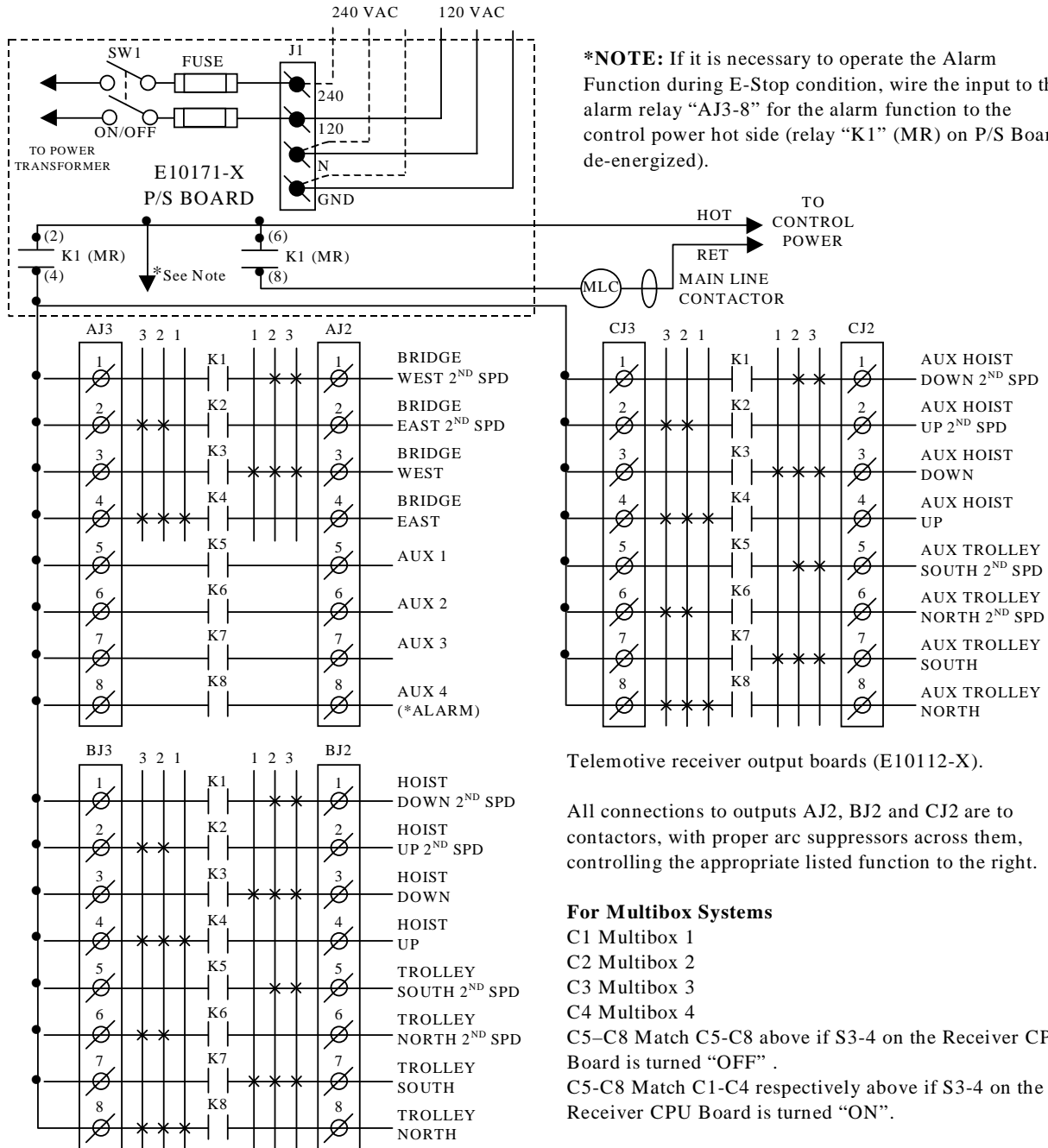

**Appendix C - 10K16/24 Pendant and SLTX
Transmitter Programming (Continued)**

TABLE 2(d)

Crane Control Type Selection: 10K24 TYPE 3 PROGRAMMING

ACCO CONTROLS: ALL MOTIONS

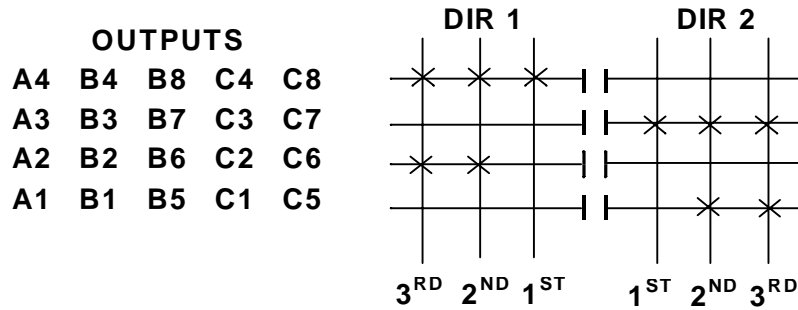

OUTPUT DEFINITIONS*

A4-A1 BRIDGE	B4-B1 HOIST	B8-B5 TROLLEY	C4-C1 AUX HOIST	C8-C5 AUX TROLLEY
A4 EAST	B4 UP	B8 NORTH	C4 UP	C8 NORTH
A3 WEST	B3 DOWN	B7 SOUTH	C3 DOWN	C7 SOUTH
A2 EAST 2 ND SPD	B2 UP 2 ND SPD	B6 NORTH 2 ND SPD	C2 UP 2 ND SPD	C6 NORTH 2 ND SPD
A1 WEST 2 ND PD	B1 DOWN 2 ND SPD	B5 SOUTH 2 ND SPD	C1 DOWN 2 ND SPD	C5 SOUTH 2 ND SPD

INDEPENDENT OUTPUTS

- A8 AUX 4 (ALARM)
- A7 AUX 3 (LATCHABLE S2-6)
- A6 AUX 2 (LATCHABLE S2-7)
- A5 AUX 1 (LATCHABLE S2-8)

*For Multibox Systems read Multibox details at the beginning of this section.

Transmitter Switch Select: Switch settings **Sw4-5** to **Sw4-8** are defined as follows:

SWITCH SETTINGS:	<u>TYPE</u>	<u>Sw4-8</u>	<u>Sw4-7</u>	<u>Sw4-6</u>	<u>Sw4-5</u>
	3	OFF	OFF	ON	ON

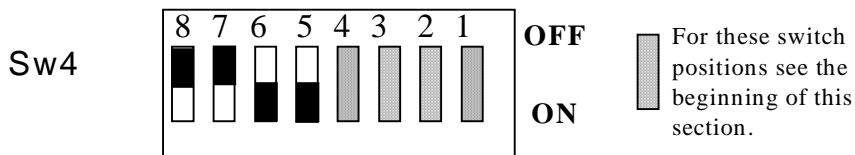

**Appendix C - 10K16/24 Pendant and SLTX
Transmitter Programming (Continued)**

TABLE 2(e)

Crane Control Type Selection: 10K24 TYPE 4 WIRING DIAGRAM

**DEMAG: 2-SPEED, 2-WINDINGS for HOIST:
STANDARD BRIDGE and TROLLEY**

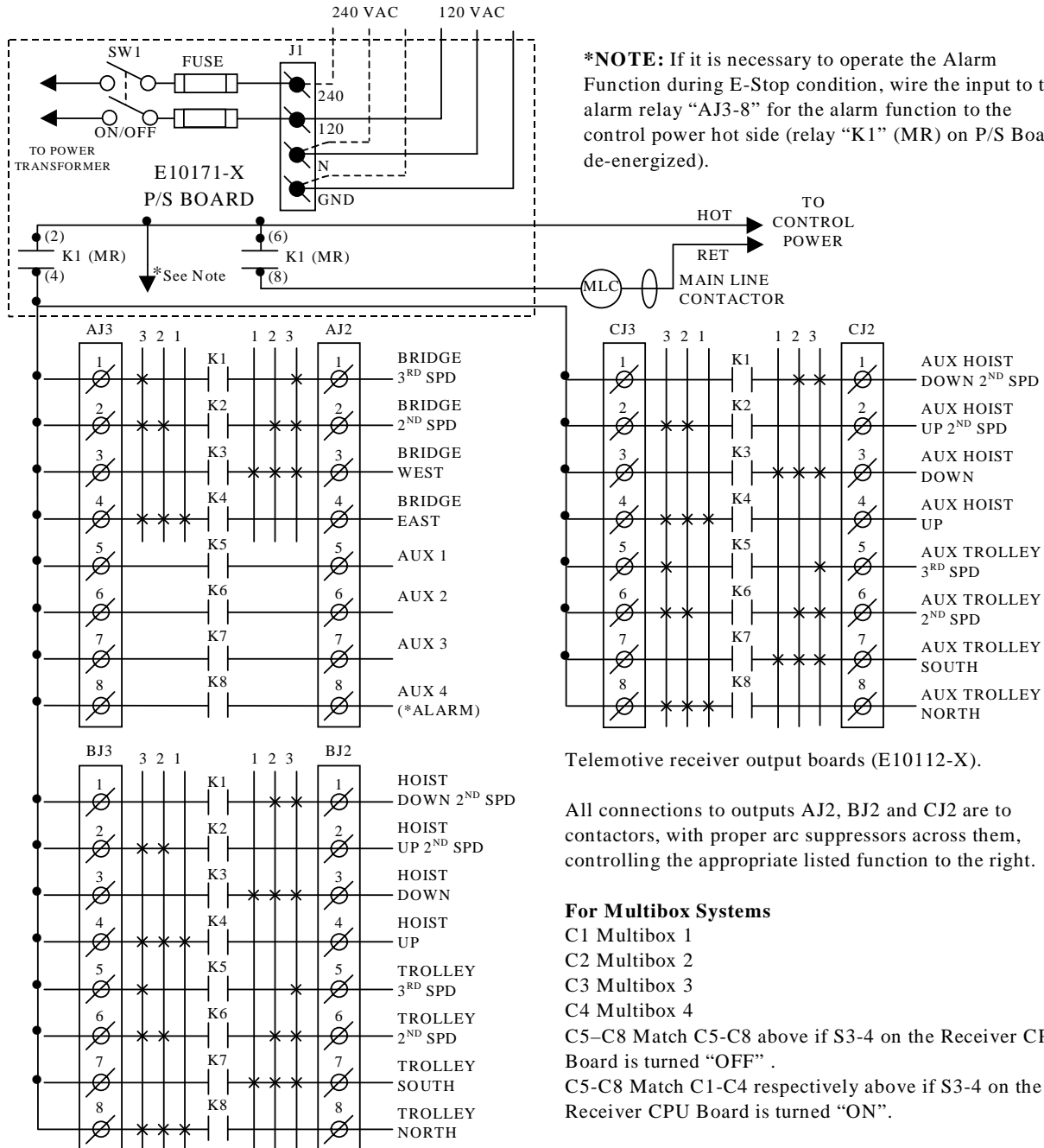

***NOTE:** If it is necessary to operate the Alarm Function during E-Stop condition, wire the input to the alarm relay "AJ3-8" for the alarm function to the control power hot side (relay "K1" (MR) on P/S Board de-energized).

Telemotive receiver output boards (E10112-X).

All connections to outputs AJ2, BJ2 and CJ2 are to contactors, with proper arc suppressors across them, controlling the appropriate listed function to the right.

For Multibox Systems

- C1 Multibox 1
- C2 Multibox 2
- C3 Multibox 3
- C4 Multibox 4
- C5-C8 Match C5-C8 above if S3-4 on the Receiver CPU Board is turned "OFF".
- C5-C8 Match C1-C4 respectively above if S3-4 on the Receiver CPU Board is turned "ON".

**Appendix C - 10K16/24 Pendant and SLTX
Transmitter Programming (Continued)**

TABLE 2(e)

Crane Control Type Selection: 10K24 TYPE 4 PROGRAMMING

**DEMAG: 2-SPEED, 2-WINDINGS for HOIST:
STANDARD BRIDGE and TROLLEY**

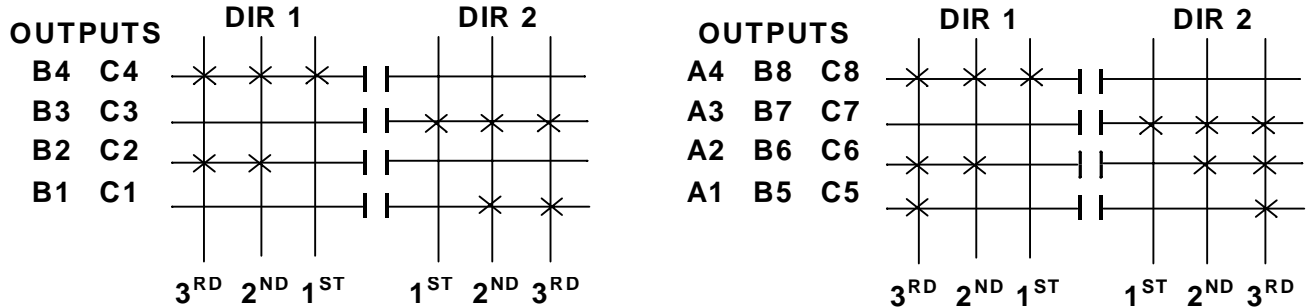

OUTPUT DEFINITIONS*

A4-A1 BRIDGE	B4-B1 HOIST	B8-B5 TROLLEY	C4-C1 AUX HOIST	C8-C5 AUX TROLLEY
A4 EAST	B4 UP	B8 NORTH	C4 UP	C8 NORTH
A3 WEST	B3 DOWN	B7 SOUTH	C3 DOWN	C7 SOUTH
A2 2 ND SPD	B2 UP 2 ND SPD	B6 2 ND SPD	C2 UP 2 ND SPD	C6 2 ND SPD
A1 3 RD SPD	B1 DOWN 2 ND SPD	B5 3 RD SPD	C1 DOWN 2 ND SPD	C5 3 RD SPD

INDEPENDENT OUTPUTS

- A8 AUX 4 (ALARM)
- A7 AUX 3 (LATCHABLE S2-6)
- A6 AUX 2 (LATCHABLE S2-7)
- A5 AUX 1 (LATCHABLE S2-8)

*For Multibox Systems read Multibox details at the beginning of this section.

Transmitter Switch Select: Switch settings **Sw4-5** to **Sw4-8** are defined as follows:

SWITCH SETTINGS:	<u>TYPE</u>	<u>Sw4-8</u>	<u>Sw4-7</u>	<u>Sw4-6</u>	<u>Sw4-5</u>
	4	OFF	ON	ON	OFF

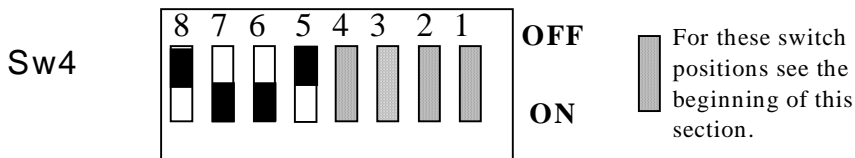

**Appendix C - 10K16/24 Pendant and SLTX
Transmitter Programming (Continued)**

TABLE 2(f)

Crane Control Type Selection: 10K24 TYPE 5 WIRING DIAGRAM

**P&H: 2-SPEED, 2-WINDINGS for HOIST:
STANDARD BRIDGE and TROLLEY**

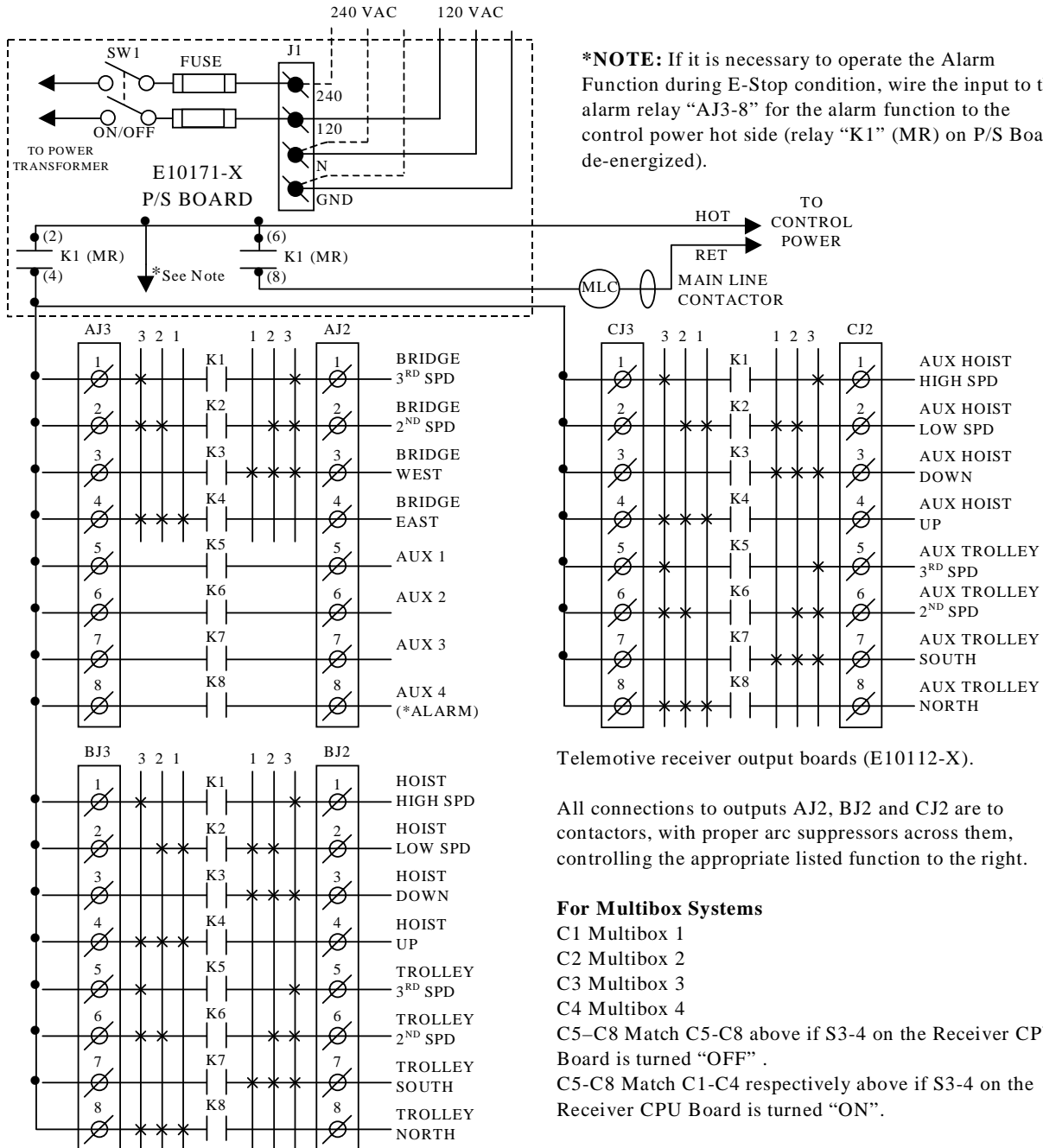

**Appendix C - 10K16/24 Pendant and SLTX
Transmitter Programming (Continued)**

TABLE 2(f)

Crane Control Type Selection: 10K24 TYPE 5 PROGRAMMING

**P&H: 2-SPEED, 2-WINDINGS for HOIST:
STANDARD BRIDGE and TROLLEY**

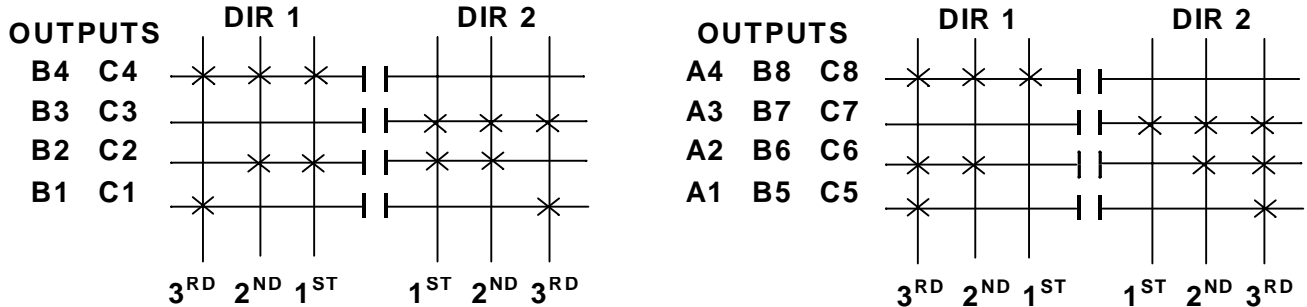

OUTPUT DEFINITIONS*

A4-A1 BRIDGE	B4-B1 HOIST	B8-B5 TROLLEY	C4-C1 AUX HOIST	C8-C5 AUX TROLLEY
A4 EAST	B4 UP	B8 NORTH	C4 UP	C8 NORTH
A3 WEST	B3 DOWN	B7 SOUTH	C3 DOWN	C7 SOUTH
A2 2ND SPD	B2 LOW SPD	B6 2ND SPD	C2 LOW SPD	C6 2ND SPD
A1 3RD SPD	B1 HIGH SPD	B5 3RD SPD	C1 HIGH SPD	C5 3RD SPD

INDEPENDENT OUTPUTS

- A8 AUX 4 (ALARM)
- A7 AUX 3 (LATCHABLE S2-6)
- A6 AUX 2 (LATCHABLE S2-7)
- A5 AUX 1 (LATCHABLE S2-8)

*For Multibox Systems read Multibox details at the beginning of this section.

Transmitter Switch Select: Switch settings **Sw4-5** to **Sw4-8** are defined as follows:

SWITCH SETTINGS:	<u>TYPE</u>	<u>Sw4-8</u>	<u>Sw4-7</u>	<u>Sw4-6</u>	<u>Sw4-5</u>
	5	OFF	ON	OFF	ON

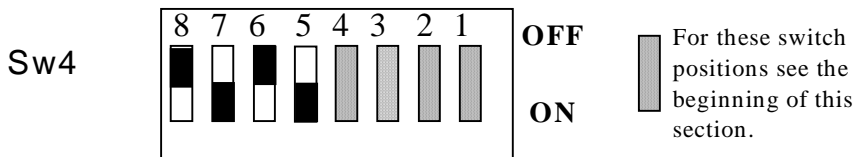

**Appendix C - 10K16/24 Pendant and SLTX
Transmitter Programming (Continued)**

TABLE 2(g)

Crane Control Type Selection: 10K24 TYPE 6 WIRING DIAGRAM

**P&H: 2-SPEED, 2-WINDINGS for HOIST and TROLLEY:
STANDARD BRIDGE**

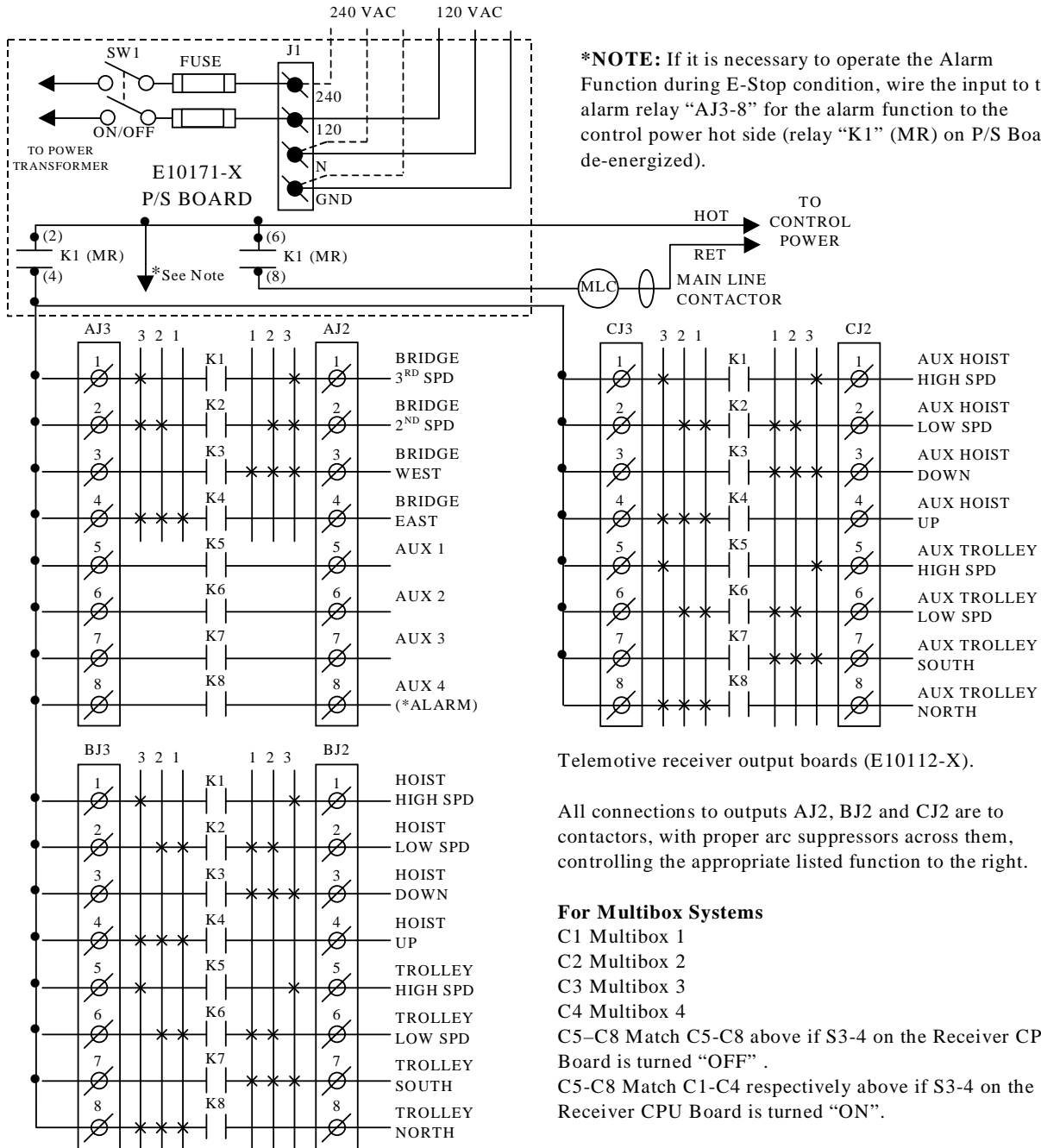

**Appendix C - 10K16/24 Pendant and SLTX
Transmitter Programming (Continued)**

TABLE 2(g)

Crane Control Type Selection: 10K24 TYPE 6 PROGRAMMING

P&H: 2-SPEED, 2-WINDINGS for HOIST and TROLLEY:
STANDARD BRIDGE

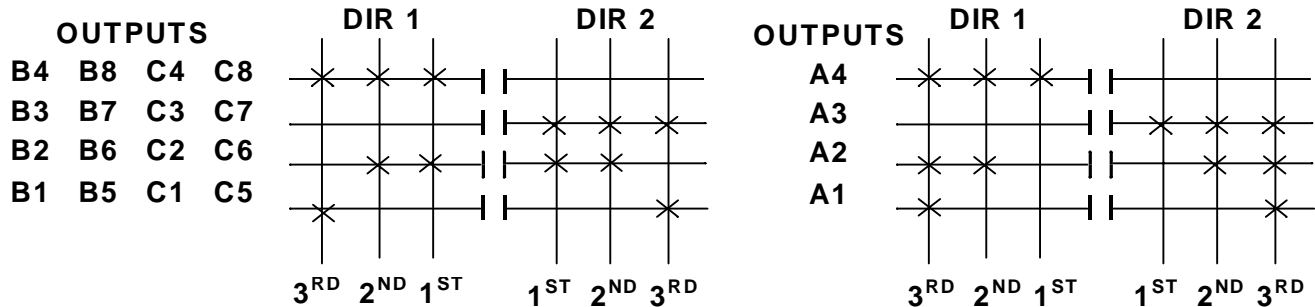

OUTPUT DEFINITIONS*

A4-A1 BRIDGE	B4-B1 HOIST	B8-B5 TROLLEY	C4-C1 AUX HOIST	C8-C5 AUX TROLLEY
A4 EAST	B4 UP	B8 NORTH	C4 UP	C8 NORTH
A3 WEST	B3 DOWN	B7 SOUTH	C3 DOWN	C7 SOUTH
A2 2 ND SPD	B2 LOW SPD	B6 LOW SPD	C2 LOW SPD	C6 LOW SPD
A1 3 RD SPD	B1 HIGH SPD	B5 HIGH SPD	C1 HIGH SPD	C5 HIGH SPD

INDEPENDENT OUTPUTS

- A8 AUX 4 (ALARM)
- A7 AUX 3 (LATCHABLE S2-6)
- A6 AUX 2 (LATCHABLE S2-7)
- A5 AUX 1 (LATCHABLE S2-8)

*For Multibox Systems read Multibox details at the beginning of this section.

Transmitter Switch Select: Switch settings **Sw4-5** to **Sw4-8** are defined as follows:

SWITCH SETTINGS:	<u>TYPE</u>	<u>Sw4-8</u>	<u>Sw4-7</u>	<u>Sw4-6</u>	<u>Sw4-5</u>
	6	OFF	ON	ON	OFF

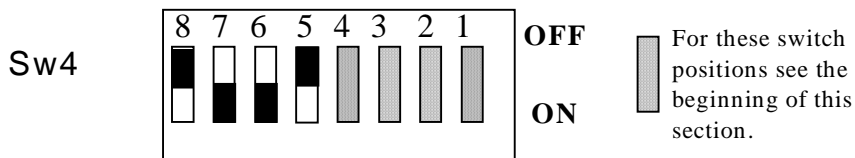

**Appendix C - 10K16/24 Pendant and SLTX
Transmitter Programming (Continued)**

TABLE 2(h)

Crane Control Type Selection: 10K24 TYPE 7 WIRING DIAGRAM

**P&H: 2-SPEED, 2-WINDINGS HOIST #1 and TROLLEYS
With CREEP SPEED HOIST #2, STANDARD BRIDGE**

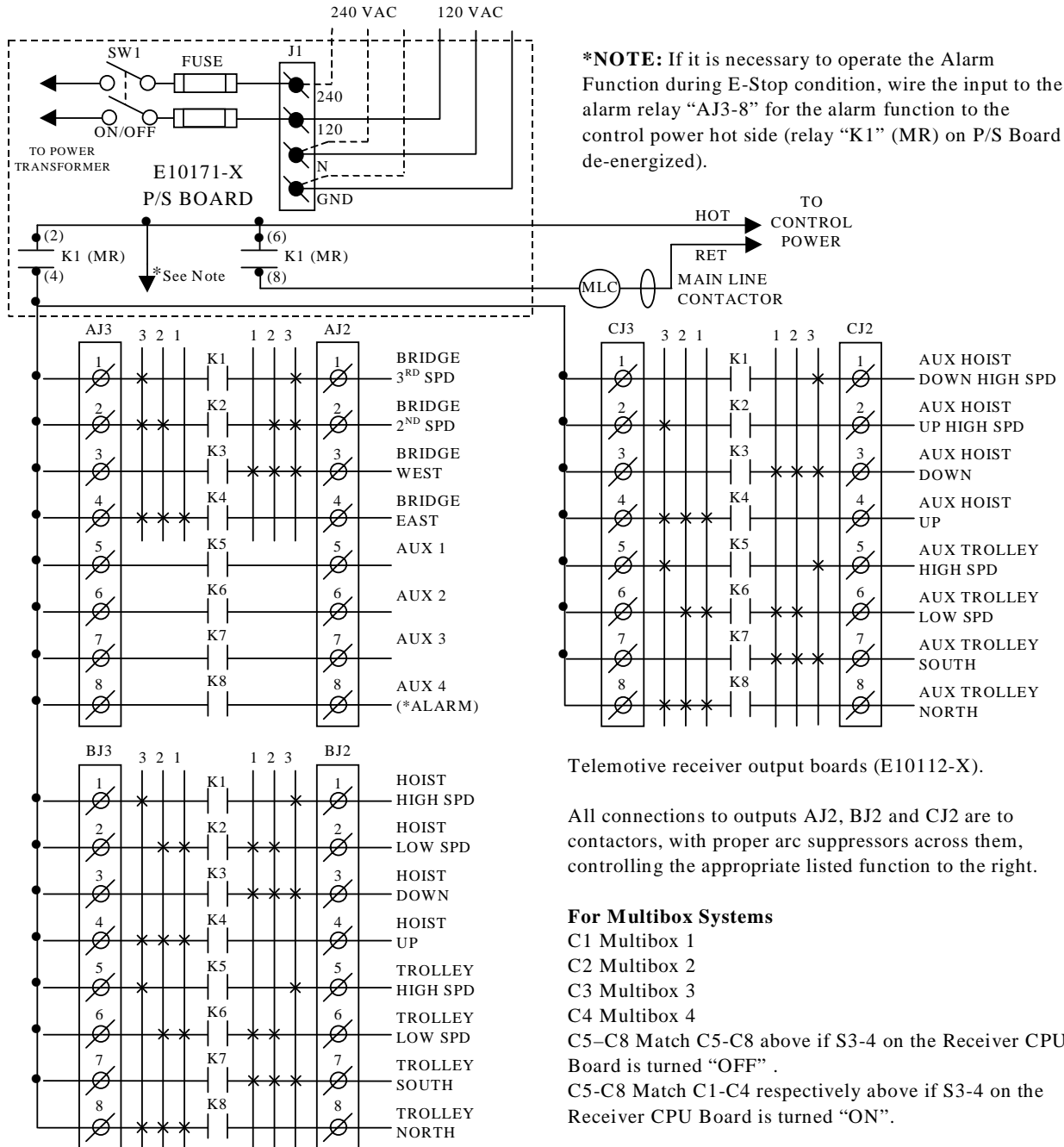

**Appendix C - 10K16/24 Pendant and SLTX
Transmitter Programming (Continued)**

TABLE 2(h)

Crane Control Type Selection: 10K24 TYPE 7 PROGRAMMING

**P&H: 2-SPEED, 2-WINDINGS HOIST #1 and TROLLEYS
With CREEP SPEED HOIST #2, STANDARD BRIDGE**

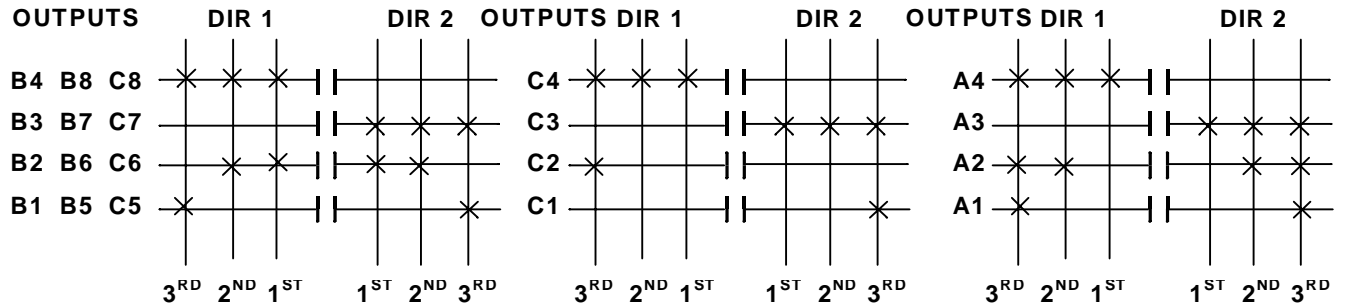

OUTPUT DEFINITIONS*

A4-A1 BRIDGE	B4-B1 HOIST	B8-B5 TROLLEY	C4-C1 AUX HOIST	C8-C5 AUX TROLLEY
A4 EAST	B4 UP	B8 NORTH	C4 UP	C8 NORTH
A3 WEST	B3 DOWN	B7 SOUTH	C3 DOWN	C7 SOUTH
A2 2 ND SPD	B2 LOW SPD	B6 LOW SPD	C2 UP HIGH SPD	C6 LOW SPD
A1 3 RD SPD	B1 HIGH SPD	B5 HIGH SPD	C1 DOWN HIGH SPD	C5 HIGH SPD

INDEPENDENT OUTPUTS

- A8 AUX 4 (ALARM)
- A7 AUX 3 (LATCHABLE S2-6)
- A6 AUX 2 (LATCHABLE S2-7)
- A5 AUX 1 (LATCHABLE S2-8)

*For Multibox Systems read Multibox details at the beginning of this section.

Transmitter Switch Select: Switch settings **Sw4-5** to **Sw4-8** are defined as follows:

SWITCH SETTINGS:	<u>TYPE</u>	<u>Sw4-8</u>	<u>Sw4-7</u>	<u>Sw4-6</u>	<u>Sw4-5</u>
	7	OFF	ON	ON	ON

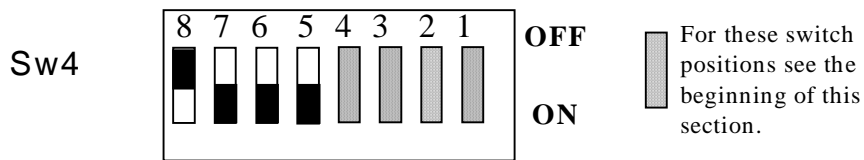

NOTE: TANDEM HOIST AND TROLLEY IS NOT AVAILABLE IN THIS CONFIGURATION

**Appendix C - 10K16/24 Pendant and SLTX
Transmitter Programming (Continued)**

TABLE 2(i)

Crane Control Type Selection: 10K24 TYPE 8 WIRING DIAGRAM

**P&H: 2-SPEED, 2-WINDINGS HOIST #1: With
CREEP SPEED HOIST #2, STANDARD BRIDGE and TROLLEYS**

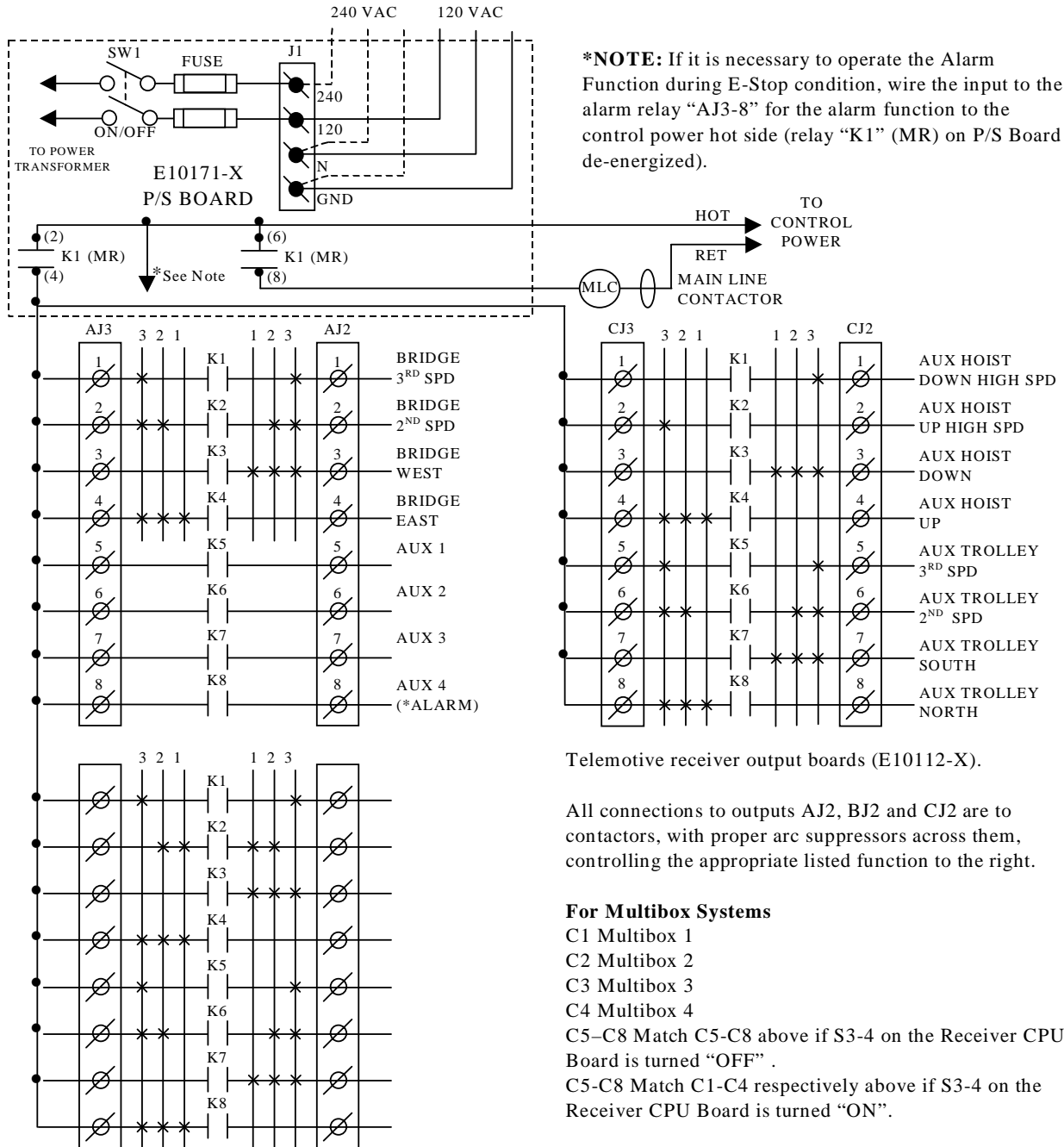

**Appendix C - 10K16/24 Pendant and SLTX
Transmitter Programming (Continued)**

TABLE 2(i)

Crane Control Type Selection: 10K24 TYPE 8 PROGRAMMING

**P&H: 2-SPEED, 2-WINDINGS HOIST #1: With
CREEP SPEED HOIST #2, STANDARD BRIDGE and TROLLEYS**

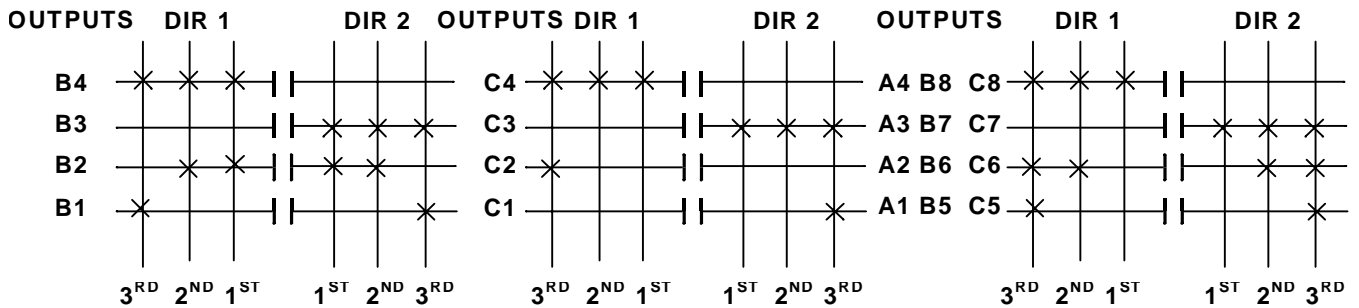

OUTPUT DEFINITIONS*

A4-A1 BRIDGE	B4-B1 HOIST	B8-B5 TROLLEY	C4-C1 AUX HOIST	C8-C5 AUX TROLLEY
A4 EAST	B4 UP	B8 NORTH	C4 UP	C8 NORTH
A3 WEST	B3 DOWN	B7 SOUTH	C3 DOWN	C7 SOUTH
A2 2 ND SPD	B2 LOW SPD	B6 2 ND SPD	C2 UP HIGH SPD	C6 2 ND SPD
A1 3 RD SPD	B1 HIGH SPD	B5 3 RD SPD	C1 DOWN HIGH SPD	C5 3 RD SPD

INDEPENDENT OUTPUTS

- A8 AUX 4 (ALARM)
- A7 AUX 3 (LATCHABLE S2-6)
- A6 AUX 2 (LATCHABLE S2-7)
- A5 AUX 1 (LATCHABLE S2-8)

*For Multibox Systems read Multibox details at the beginning of this section.

Transmitter Switch Select: Switch settings **Sw4-5** to **Sw4-8** are defined as follows:

SWITCH SETTINGS:	<u>TYPE</u>	<u>Sw4-8</u>	<u>Sw4-7</u>	<u>Sw4-6</u>	<u>Sw4-5</u>
	8	ON	OFF	OFF	OFF

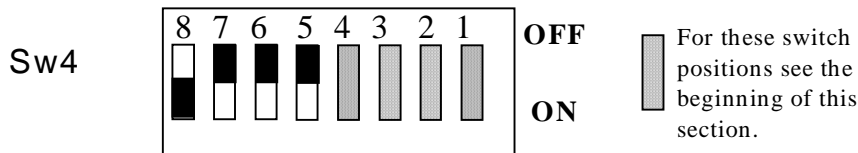

NOTE: TANDEM HOIST AND TROLLEY IS NOT AVAILABLE IN THIS CONFIGURATION

**Appendix C - 10K16/24 Pendant and SLTX
Transmitter Programming (Continued)**

TABLE 2(j)

Crane Control Type Selection: 10K24 TYPE 9 WIRING DIAGRAM

**STANDARD 5-SPEED, INTERFACE
With SLTX LEVER SWITCH TRANSMITTER**

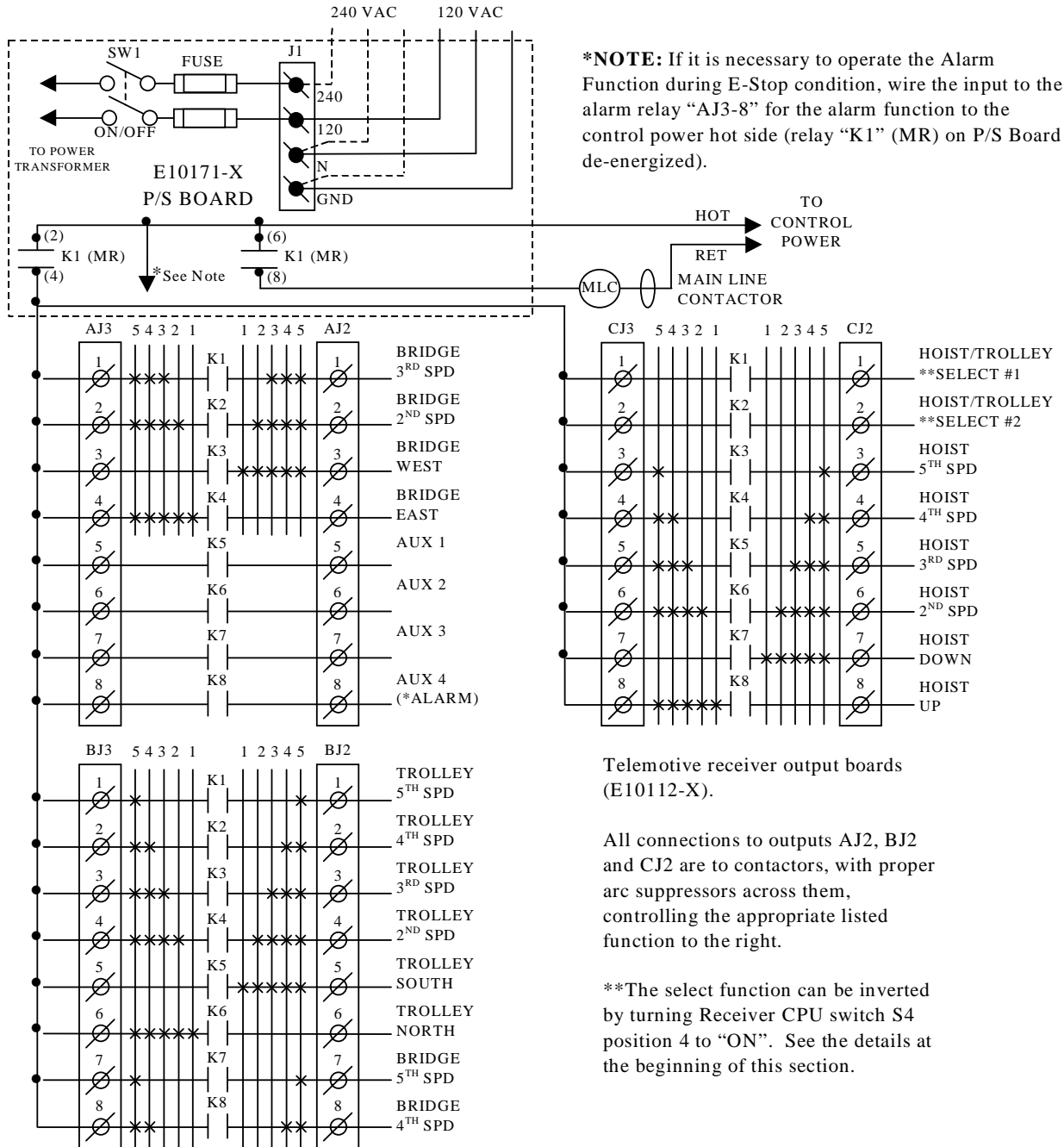

**Appendix C - 10K16/24 Pendant and SLTX
Transmitter Programming (Continued)**

TABLE 2(j)

Crane Control Type Selection: 10K24 TYPE 9 PROGRAMMING

**STANDARD 5-SPEED, INTERFACE
With SLTX LEVER SWITCH TRANSMITTER**

EAST				OFF	WEST				J2 OUTPUT TERMINAL
X	X	X	X					A4 BRIDGE	
					X	X	X	A3 BRIDGE	
X	X	X	X			X	X	A2 BRIDGE	
X	X	X				X	X	A1 BRIDGE	
X	X					X	X	B8 BRIDGE	
X							X	B7 BRIDGE	

NORTH				OFF	SOUTH				J2 OUTPUT TERMINAL
X	X	X	X					B6 TROLLEY	
					X	X	X	B5 TROLLEY	
X	X	X	X			X	X	B4 TROLLEY	
X	X	X				X	X	B3 TROLLEY	
X	X					X	X	B2 TROLLEY	
X							X	B1 TROLLEY	

UP				OFF	DOWN				J2 OUTPUT TERMINAL
X	X	X	X					C8 HOIST	
					X	X	X	C7 HOIST	
X	X	X	X			X	X	C6 HOIST	
X	X	X				X	X	C5 HOIST	
X	X					X	X	C4 HOIST	
X							X	C3 HOIST	

OUTPUT DEFINITIONS

A4-A1 BRIDGE	B8-B7 BRIDGE	B6-B5 TROLLEY	B4-B1 TROLLEY	C8-C5 HOIST	C4-C3 HOIST
A4 EAST	B8 4TH SPD		B4 2ND SPD	C8 UP	C4 4TH SPD
A3 WEST	B7 5TH SPD		B3 3RD SPD	C7 DOWN	C3 5TH SPD
A2 2ND SPD		B6 NORTH	B2 4TH SPD	C6 2ND SPD	
A1 3RD SPD		B5 SOUTH	B1 5TH SPD	C5 3RD SPD	

INDEPENDENT OUTPUTS

- A8 AUX 4 (ALARM)
- A7 AUX 3 (LATCHABLE S2-6)
- A6 AUX 2 (LATCHABLE S2-7)
- A5 AUX 1 (LATCHABLE S2-8)
- C2 HOIST/TROLLEY SELECT #2
- C1 HOIST/TROLLEY SELECT #1

SLTX Transmitter Switch Select: Switch settings **Sw4-5** to **Sw4-8** are defined as follows:

SLTX SWITCH SETTINGS:	<u>TYPE</u>	<u>Sw4-8</u>	<u>Sw4-7</u>	<u>Sw4-6</u>	<u>Sw4-5</u>
	8	OFF	OFF	OFF	OFF

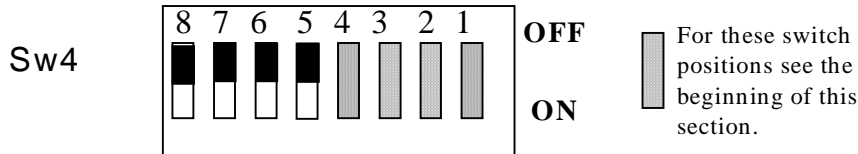

**Appendix C - 10K16/24 Pendant and SLTX
Transmitter Programming (Continued)**

TABLE 2(k)

Repositioning of transmitter pushbutton switch functions for pendant only.

SW3 positions 1 through 3 can change the functional positions of the switches controlling trolley, hoist and bridge. This can be useful to align East/West and North/South. This reconfiguration does NOT affect receiver wiring.

WARNING

CHANGING THESE SWITCHES CHANGES THE FUNCTIONAL OPERATION OF THE CRANE IN RELATIONSHIP TO THE TRANSMITTER BUTTON BEING DEPRESSED. THE FUNCTIONAL OPERATION OF THE CRANE SHOULD NEVER BE CHANGED WITHOUT ALL PERSONNEL RESPONSIBLE FOR CRANE OPERATION BEING NOTIFIED PRIOR TO MODIFICATION.

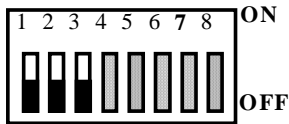
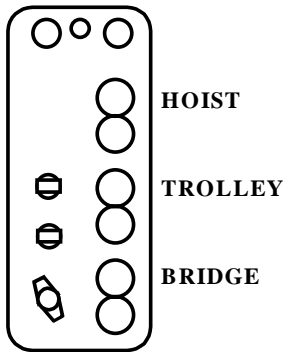

Standard Configuration

