

Yale YK Wire Rope Hoist

Top-Running Hoist and Trolley

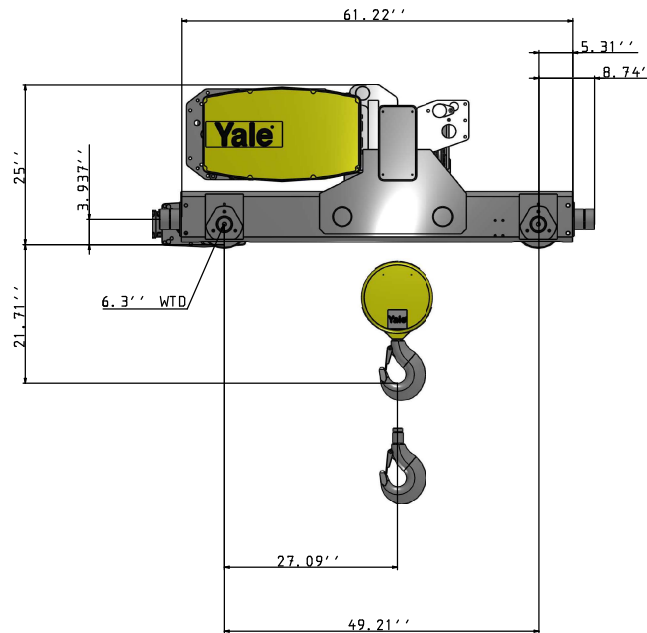
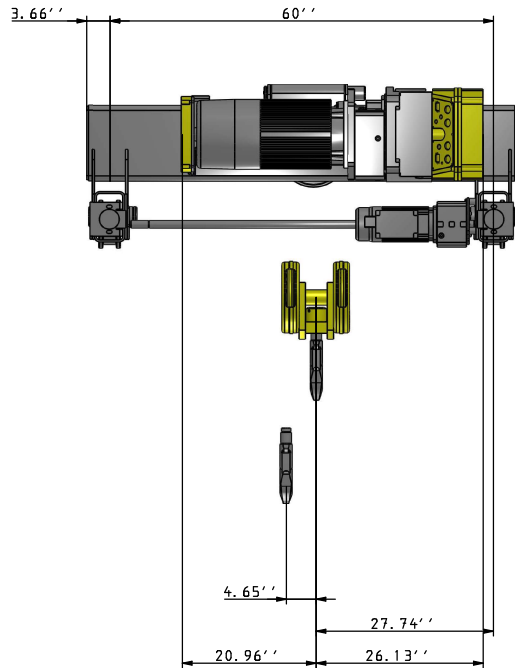
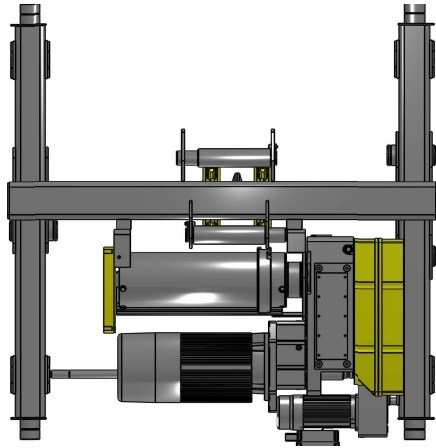

Customer Name: QUOTATIONS CUSTOMER
 Quote Number: J5RNF, Line: 1
 Revision Number: 1
 Quote Date: 5/5/2020

TECHNICAL DATA

Hoist Platform	GN Wire Rope Hoist
Hoist Model Number	YKC-T12-020S413-2-60
Rated Lift Capacity	12.5 U.S. tons
Maximum Lift Distance	20 ft (6.1 m)
Maximum Lifting Speed	13 ft/min (3.96 m/min)
Reeving Style	4-Part Single-Reeved
Hoist Control Type	Two-Speed
Hoist Suspension Type	Top Running Low Profile
Bridge Rail Size Min. (lb/yd)	25#
Bridge Rail Size Max.	40#
Trolley Traverse Speed (60Hz)	80 ft/min (24.38 m/min)
Trolley Control Type	Two-Speed
Trolley Bumpers	Included
Hoist Duty Classification	HMI Class H4
Operating Voltage	460V / 3ph / 60Hz
Control Voltage	120 VAC
Trolley Motor HP	2.0
Trolley Motor Qty	1
Base Weight of Hoist (lbs)	2032.59

This document was generated by COMPASS®
 by Columbus McKinnon Corporation
 Getzville, New York USA

This drawing is intended for preliminary reference use only and depicts general clearance dimensions based on standard product configuration. If your application includes specific critical dimensional constraints it is recommended that an Approval Drawing be requested at time of order.

